

# LedsC4

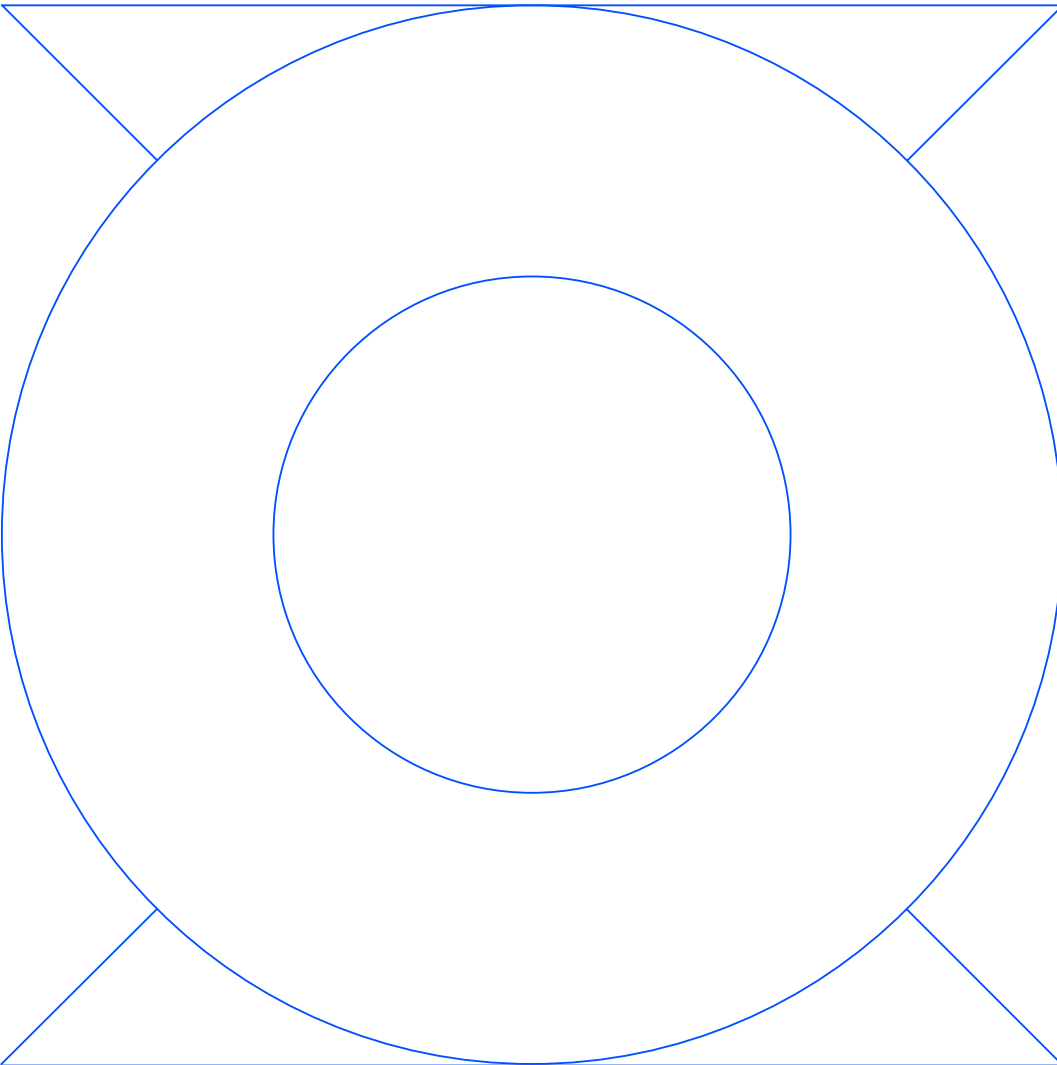

**2023**  
Architectural  
Collection

Indoor  
Outdoor





# Indoor

N

Producto novedad  
Produto novidade

E

Producto esencial  
Produto essencial

## Indoor Collections

### Atom 024



Track  
077



Low Voltage  
115



Hide  
325

N



Recessed  
331

N



Surface  
319

### Iris 034

N



Track Spotlight  
087



Track Pendant  
087



Low Voltage  
Spotlight  
119



Low Voltage  
Pendant  
119



Low Voltage  
Downlight  
119



Spotlight Recessed  
297



Spotlight Surface  
297



Pendant Recessed  
289



Pendant Surface  
289



Ceiling  
297

### Bento 050



Standard  
235



Adjustable  
243



Surface  
334



IP Recessed  
235

N



IP66 Surface  
337

N



Wall Washer  
249



Low Voltage  
123



Low Voltage Wall  
Washer  
123

### Luno Slim 062

N



Surface  
303



Pendant  
283

### Multidir EVO 065



Surface  
313



Recessed  
253

### Kiva 072

N



Surface  
339

N









Recessed  
275



Low Voltage  
117

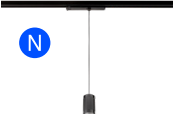













**Proyectores / Carilles**  
**Projetores / Calhas**

075

<b>Atom</b>  Track 077	<b>Iris</b>  Track Spotlight 087	<b>Iris</b>  Track Pendant 087	<b>Tak</b>  091	<b>Strom</b>  093	<b>Play</b>  Track 108	<b>Track</b>  097
-----------------------------------------------------------------------------------------------------------------	----------------------------------------------------------------------------------------------------------------------------	--------------------------------------------------------------------------------------------------------------------------	--------------------------------------------------------------------------------------------------------	-----------------------------------------------------------------------------------------------------------	--------------------------------------------------------------------------------------------------------------------	------------------------------------------------------------------------------------------------------------











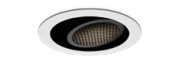

**Baja Tensión**  
**Baixa tensão**

109

<b>Atom</b>  115	<b>Kiva</b>  117	<b>Iris</b>  Spotlight 119	<b>Iris</b>  Pendant 139	<b>Strom</b>  Downlight 139	<b>Strom</b>  141	<b>Tango</b>  121
<b>Bento</b>  123	<b>Bento</b>  Wall Washer 144	<b>Infinite</b>  129	<b>On</b>  127	<b>Nara</b>  125	<b>Vela</b>  145	<b>Track</b>  131

**Downlights**

159

<b>Sia</b>  161	<b>Biwa</b>  181	<b>Veo</b>  185	<b>Vol</b>  190	<b>Play</b>  193	<b>Lite</b>  225	<b>Dome</b>  231
<b>Ges</b>  232	<b>Bento</b>  235	<b>Luno</b>  251	<b>Multidir Evo</b>  253	<b>Totem</b>  261	<b>Ecofit</b>  265	<b>Kiva</b>  275

**Colgantes / Apliques**  
**Suspensões / Apliques**

279

**Pek**



281

**Luno Slim**

N



283

**Luno**



287

**Iris**



289

**Play**

N



293

**Maai**



295

**Proyectores / Plafones**  
**Projetores / Plafons**

296

**Iris**



Ceiling  
297



Spotlight  
297

**Leco**



302

**Luno Slim**

N



303

**Luno**



307

**Ges**



309

**Play**



Deco  
310



Spot Surface  
310

**Exit**



311

**Mutidir Evo**



313

**Atom**



325



319

N



331

**Bento**



334

N



IP66  
337

**Kiva**

N



339

**Sistemas Lineales**  
**Sistemas Lineares**

341

**Apex**

N



343

**Infinite Pro**

N



363

**Infinite Slim**

N

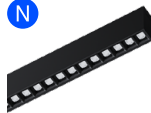

401

**Lineal**

E



407

**Taglio di Luce**



409

N  
 Producto novedad  
 Produto novidade

E  
 Producto esencial  
 Produto essencial

Tiras LED  
Fitas LED

423

Asai 3D



425

On



433

Señalización  
Sinalização

449

Paso



451

Click



456

Bat



459

Sign



466

Secret



467

Step



468

# Outdoor

N

Producto novedad  
Produto novidade

E

Producto esencial  
Produto essencial

## Outdoor Collections

Max

474

N



Spotlight  
626



Bollard  
810



Downlight  
736



Uplight  
676



Wall Fixture  
862



Ceiling  
924

Modis

472

N



Spotlight  
634

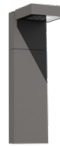

Bollard  
790



Lampost  
790



Uplight  
000



Wall Fixture  
854



Ceiling  
932

Orbit

472

N



Rechargeable  
784



Plug & Play  
789



Bollard  
784



Lampost  
785

Rack

472



Rechargeable  
963



Plug & Play  
984



Bollard  
966



Wall Fixture  
968

**Sistemas Lineales**  
Sistemas Lineares

515

**Taglio**

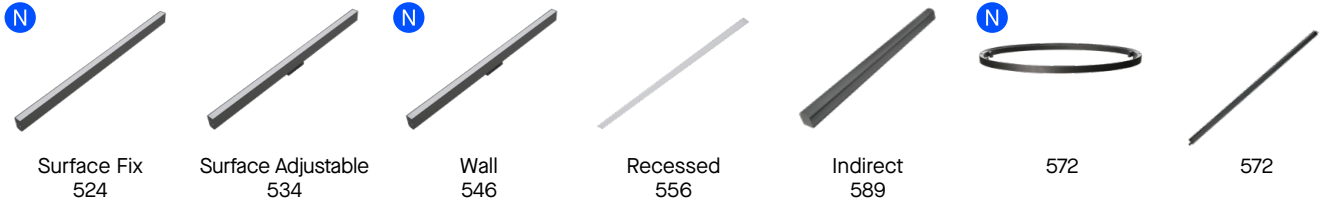

**Vercle**

**Convert**

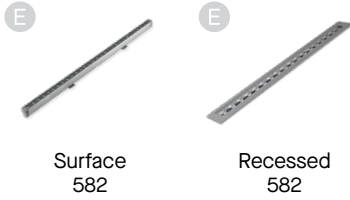

**Mex**

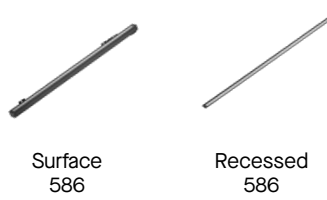

**Cube Linear**

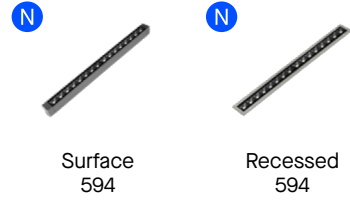

**Proyectores**  
Projetores

613



**Sumergibles**  
Submersíveis

667

**Aqua**



## Empotrables de techo

Encastráveis de teto

# 733

Max

N



736

Dako

E



746

Gea



LED  
752

E



GU10  
752

## Empotrables de pared

Encastráveis de parede

# 753

Micenas

N



758

Arc



770

Click

N

E



756

Bat

N



760

Tiny



768

Gea



770

## Empotrables de suelo

Encastráveis no solo

# 673

Max

N



676

Gea

N



Pro  
690

N



Cob  
698

N



Wall Washer  
701



Compact  
704



Technopolymer  
708



Signaling  
706

Kay



714

los



Symetrical  
718



Asymetrical  
718

Rim



724

Pixel

N



728

Xena

N



732

## Uplights de Superficie

Uplights no Superficie

# 771

Xena

N



774

Rexel



776

Soul



778

Modis



000

N

Producto novedad  
Produto novidade

E

Producto esencial  
Produto essencial

**Balizas / Farolas**















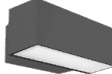



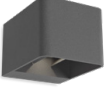









Balizas / Postes de iluminação

781











<p><b>Orbit</b></p> <p><b>N</b></p>  <p>Bollard 784</p>  <p>Lampost 789</p>		<p><b>Modis</b></p>  <p>Bollard 790</p>  <p>Lampost 795</p>		<p><b>Helion</b></p> <p><b>N</b></p>  <p>Bollard 796</p> <p><b>N</b></p>  <p>Lampost 779</p>	
<p><b>Lyon</b></p>  <p>Bollard 800</p>  <p>Lampost 801</p>		<p><b>Juncus</b></p> <p><b>N</b></p>  <p>Bollard 802</p>  <p>Lampost 802</p>		<p><b>Invisible</b></p>  <p>806</p> <p><b>N</b></p>  <p>810</p>	
<p><b>Newton</b></p>  <p>LED Pro 824</p>  <p>LED 828</p>  <p>E27 829</p>		<p><b>Dan</b></p> <p><b>E</b></p>  <p>830</p>		<p><b>Row</b></p>  <p>834</p>	
<p><b>Cubik</b></p>  <p>LED 838</p>  <p>E27 840</p>		<p><b>Priap</b></p>  <p>842</p>		<p><b>Nott</b></p>  <p>843</p>	
<p><b>Balizas</b></p> <p><b>E</b></p>  <p>844</p>		<p><b>Way</b></p>  <p>845</p>		<p><b>Cubus</b></p>  <p>846</p>	
<p><b>Zigzag</b></p>  <p>850</p>		<p><b>Citizen</b></p>  <p>847</p>		<p><b>Proud</b></p>  <p>848</p>	













**Apliques**  
Apliques  
852

Modis	Max	Cosmos	Afrodita			
						
854	859	865	Infinite 870	LED 870	Power LED 870	Tech 870
Nemesis	Wilson	Clous	Simenti	Diago	Venus	
						
GU10 870	882	884	886	886	887	889
Finestra	Moal	Rack				
<b>Apliques iluminación decorativa</b> Apliques iluminação decorativa						
	RGBW DMX 890	Standard 890	969	910	910	
Arc	Sam	Kossel	Cubus			
<b>Apliques zonas de paso</b> Apliques zonas de passagem						
	894	896	Indirect 900	Direct 900	904	
Skat	Curie	Darwin	Basic	Mega		
<b>Apliques de iluminación directa</b> Apliques iluminação direta						
	906	913	905	Aluminium 915	939	

**Plafones**  
Plafons  
**921**

<b>Max</b>	<b>Cosmos</b>	<b>Modis</b>	<b>Afrodita</b>	<b>Mega</b>	<b>Kössel</b>
					
923	927	931	941	939	942
<b>Solid</b>	<b>Soul</b>	<b>Bento IP66</b>	<b>Basic</b>		
					
943	977	ID 937	916		

**Chillout**  
**945**

<b>Orbit</b>	<b>Rack</b>		<b>Moal</b>			
						
Rechargeable 947	Plug & Play 947	Rechargeable 957	Plug & Play 957	Bollard 957	Wall Fixture 957	969
<b>Barcino</b>	<b>Moonlight</b>	<b>Cisne</b>				
						
973	975	Pendant 979	Surface 979			

# Emergency Lighting

## Redo



989



Surface  
989

## Deco



994



Track  
1001

## Flag



1000

## Star



1000

## Line



1003

## Leco



1005

## Play



1007

## Infinite Pro

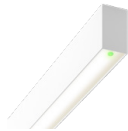

1023

## Sia



1035

## Bento



1029

## Veo



1040

## Afodita

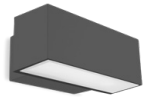

1033

## Solid



1034

## Ecofit



1042



Producto novedad  
Produto novidade



Producto esencial  
Produto essencial

# Smart Lighting

**D4i**



1048

**DALI2**



1050

**Bluetooth Casambi DMX**



1052



1056

**Light for Life**



1058

**Standalone**



1060



---

# Light for better living

La luz de calidad mejora  
los espacios que ilumina  
A luz de qualidade melhora  
os espaços que ilumina

---

La luz de calidad mejora los espacios que ilumina, provoca emociones y cambia la percepción de un espacio, moldeándolo con su presencia silenciosa. La buena luz acompaña y cuida, contribuye al bienestar y mejora la calidad de vida de las personas.

Nuestra cultura de la luz se traduce en una pasión por explorar sus posibilidades, entenderla, experimentarla y crear soluciones con el mejor equilibrio entre calidad, diseño, tecnología, servicio y cuidado por el medio ambiente.

Acumulamos una trayectoria de más de 50 años de experiencia, fabricando y diseñando producto y ofreciendo un servicio de acompañamiento en todas las fases lumínicas de proyectos muy diversos, tanto de interior como de exterior, para que iluminar con luz de calidad, sea lo más fácil posible.

Uma luz de qualidade melhora os espaços que ilumina, provoca emoções e muda a percepção de um espaço, moldando-o com a sua presença silenciosa. A boa luz acompanha e cuida, contribui para o bem-estar e melhora a qualidade de vida das pessoas.

A nossa cultura da luz traduz-se numa paixão por explorar as suas possibilidades, compreendê-la, experimentá-la e criar soluções com o melhor equilíbrio entre qualidade, design, tecnologia, serviço e cuidado com o ambiente.

Temos mais de 50 anos de experiência na fabricação e conceção de produtos e oferecemos um serviço de acompanhamento em todas as fases lumínicas de uma vasta gama de projetos, tanto de interior como de exterior, para tornar a iluminação com luz de qualidade tão fácil quanto possível.









---

# Valentía y compromiso desde el origen

# Coragem e compromisso desde a origem

Innovación es motivación  
Inovação é motivação

---

LedsC4 tiene base en Torà, una localidad rural ubicada en La Segarra (Lleida). Rodeados de un paisaje natural, nuestros orígenes se remontan al hierro forjado, material con el que se diseñó la primera luminaria de la compañía, hace más de 50 años.

Con curiosidad, valentía y afán por recorrer un camino donde la innovación es motivación, transitamos una historia con la experimentación como seña de identidad y parte de nuestro ADN.

Después de ser pioneros en la introducción de las lámparas halógenas y el LED, con diseños realizados en alabastro, hoy, que contamos con varios centros de innovación y desarrollo de producto y una distribución en más de 140 países, seguimos siendo fieles a nuestra identidad y a nuestro entorno.

LedsC4 está sediada em Torà, uma cidade rural localizada em La Segarra (Lleida). Rodeados por uma paisagem natural, as nossas origens remontam ao ferro forjado, material com que a primeira luminária da empresa foi criada há mais de 50 anos.

Com curiosidade, coragem e vontade de percorrer um caminho onde a inovação é motivação, experimentar é para nós um sinal de identidade e faz parte do nosso ADN.

Depois de sermos pioneiros na introdução de lâmpadas de halogéneo e LED, com designs realizados em alabastro, hoje, com vários centros de inovação e desenvolvimento de produto e uma distribuição em mais de 140 países, continuamos fiéis à nossa identidade e ao nosso ambiente.

---

# Diseño, calidad y tecnología

## Design, qualidade e tecnologia

---

Nuestras soluciones están desarrolladas por expertos en iluminación técnica y decorativa, que trabajan siguiendo unos estrictos criterios de calidad.

Técnicos e ingenieros de LedsC4 colaboran con diseñadores y lighting designers, tanto internos como externos, para desarrollar desde la conceptualización del producto hasta la ingeniería mecánica para su instalación, pasando por el diseño volumétrico y tecnológico, la selección de materiales y el modelaje; todo ello siguiendo criterios de eco-diseño que buscan la máxima eficiencia energética y reciclabilidad del producto y sus componentes.

As nossas soluções são desenvolvidas por especialistas em iluminação técnica e decorativa, que trabalham de acordo com rigorosos critérios de qualidade.

Os técnicos e engenheiros da LedsC4 colaboram com designers e lighting designers, tanto internos como externos, para desenvolver desde a concetualização do produto até à engenharia mecânica para a sua instalação, incluindo o design volumétrico e tecnológico, a seleção de materiais e a modelação; tudo isso seguindo critérios de ecodesign que procuram a máxima eficiência energética e a reciclabilidade do produto e dos seus componentes.

Los diseñadores nutren nuestro portfolio con su visión personal de la luz, compartiendo nuestra pasión y la forma de entenderla.

Os designers alimentam o nosso portefólio com a sua visão pessoal da luz, partilhando a nossa paixão e forma de entendê-la.



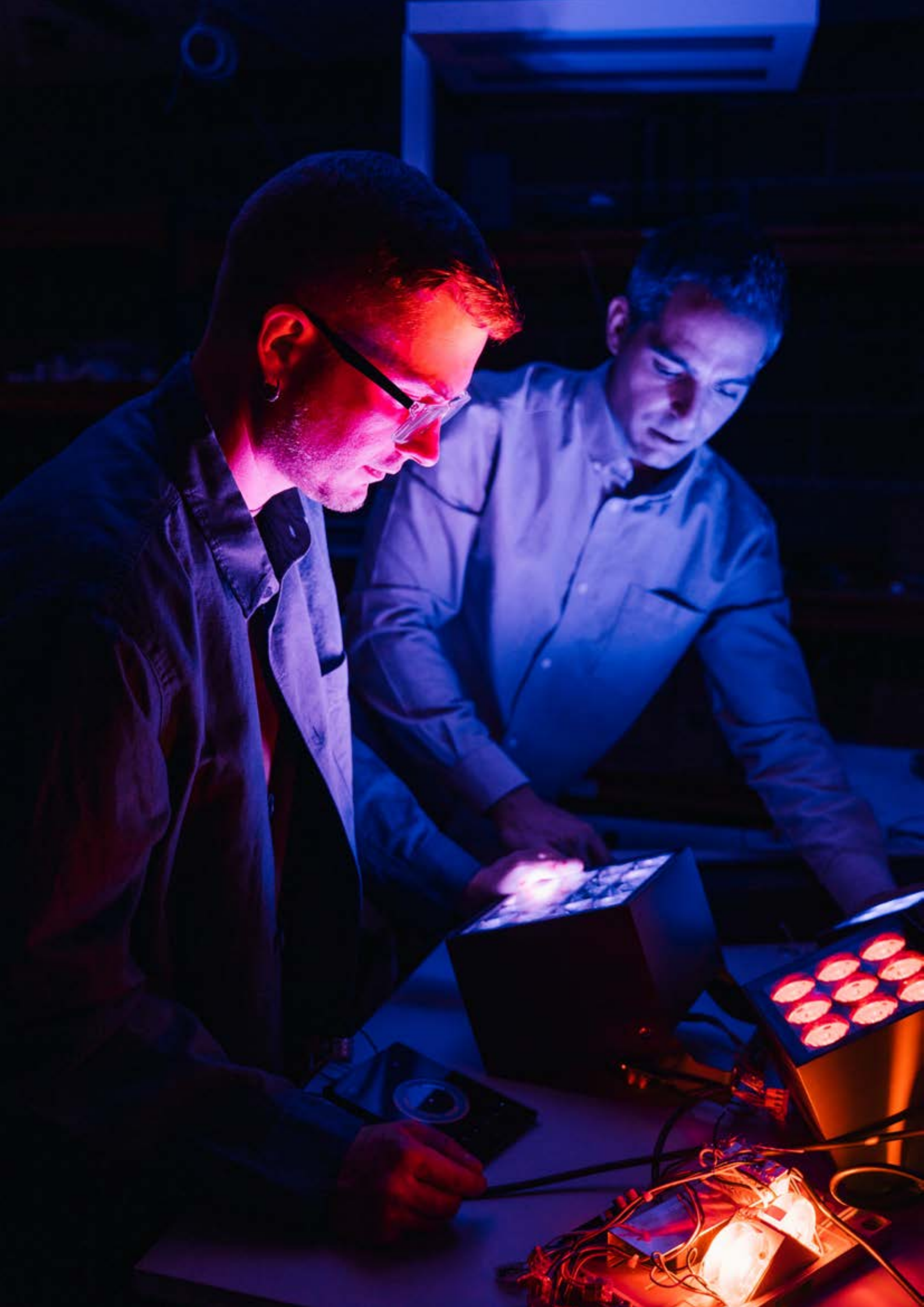



# Tecnología para una iluminación avanzada y eficiente

# Tecnologia para iluminação avançada e eficiente

Nuestra trayectoria y experiencia en iluminación nos permite ofrecer soluciones de iluminación avanzadas y eficientes, desarrolladas por nuestros departamentos de innovación, con servicios digitales y tecnología de control y conectividad.

A nossa trajetória e experiência em iluminação permite-nos oferecer soluções de iluminação avançadas e eficientes, desenvolvidas pelos nossos departamentos de inovação, com serviços digitais e tecnologia de controlo e conectividade.

## Control y conectividad Controlo e conectividade

El 75% de nuestro  
catálogo es conectivo  
75% do nosso catálogo  
é conectivo



## Innovación continua Inovação contínua

Ofrecemos soluciones  
controladas y eficientes  
Oferecemos soluções  
controladas e eficientes



# Cuidamos todos los procesos

## Cuidamos de todos los procesos

Cuidamos al detalle todos los procesos, desde el desarrollo; pasando por el diseño, fabricación y las pruebas de calidad, hasta la entrega e instalación, cumpliendo con un servicio rápido, efectivo y fácil.

Contamos con un centro de producción en Torà y un centro de Diseño e Innovación en Madrid, especializado en retail y soluciones integradoras que responden a la exigencia de calidad y adaptación al ritmo circadiano para el bienestar de las personas.

Cuidamos em detalhe de todos os processos, desde o desenvolvimento, passando pela conceção, fabricação e testes de qualidade, até à entrega e instalação, prestando um serviço rápido, eficaz e fácil.

Temos um centro de produção em Torà e um centro de Design e Inovação em Madrid, especializado em retail e soluções integradoras que respondem à exigência de qualidade e adaptação ao ritmo circadiano para o bem-estar das pessoas em diferentes aplicações.





---

# Proyectos lumínicos y customización

## Projetos lumínicos e personalização

---

Nuestro equipo de proyectos lumínicos conceptualiza la iluminación de un espacio teniendo en cuenta las intenciones y emociones a transmitir. A partir de este moodboard se realiza un cálculo lumínico en el que se detallan las luminarias más idóneas para conseguir el objetivo marcado del ambiente, tanto en cantidad como posición y características tecno-lumínicas.

Además de proyectos standard también abordamos proyectos personalizados en los que se requieren soluciones customizadas y flexibles. En nuestro centro de producción de Torà realizamos customización de color y adaptamos las características técnicas del producto y su instalación cuando es necesario. En el Centro de Diseño e Innovación de Madrid abordamos proyectos 100% personalizados y a medida.

A nossa equipa de projetos lumínicos concetualiza a iluminação de um espaço tendo em conta as intenções e as emoções a transmitir. Com base neste moodboard realiza-se um cálculo lumínico no qual se detalham as luminárias mais adequadas para conseguir o objetivo estabelecido para o ambiente, tanto em termos de quantidade e posição como de características técnico-lumínicas.

Além de projetos standard, realizamos também projetos personalizados onde são necessárias soluções personalizadas e flexíveis. No nosso centro de produção de Torà personalizamos as cores e adaptamos as características técnicas do produto e a sua instalação quando necessário. No Centro de Design e Inovação de Madrid abordamos projetos 100% personalizados e à medida.

Cada proyecto de iluminación es único, por lo que generamos soluciones flexibles y adaptables  
Cada projeto de iluminação é único, pelo que geramos soluções flexíveis e adaptáveis





---

# Sostenibilidad y compromiso social Sustentabilidade e compromisso social

---

Cuidar nuestro entorno, respetándolo, con el firme compromiso de generar un impacto positivo, es uno de los propósitos de nuestro día a día

Cuidar do nosso ambiente, respeitando-o, com o firme propósito de gerar um impacto positivo, é um dos objetivos do nosso dia a dia





### Despedimos 2022 con:

#### Dizemos adeus a 2022 com:

- El 98% de contratos fijos  
98% de contratos fixos
- Más del 90% de luminarias segregables y con LED y driver reemplazable  
Mais de 90% de luminárias segregáveis e com LED e driver substituível
- Reducción de 28.300kg de cartón y 505Kg de plástico en embalajes  
Uma redução de 28.300kg de cartão e 505kg de plástico na embalagem
- Certificado de declaración ambiental EPD  
Certificado de declaração ambiental EPD
- Medalla de oro de EcoVadis en sostenibilidad  
Medalha de ouro da EcoVadis para a sustentabilidade



### Nuestra hoja de ruta para 2026 es:

#### O nosso roteiro para 2026 é:

- 100% plantilla formada en buenas prácticas medioambientales  
100% do quadro de pessoal formado em boas práticas ambientais
- 100% packaging sostenible  
100% packaging sustentável
- 60% luminarias regulables  
60% luminárias reguláveis
- 95% de luminarias segregables  
95% das luminárias segregáveis
- 65% de luminarias construidas con material reciclable  
65% das luminárias feitas de material reciclável
- 15% reducción huella de carbono  
15% de redução da pegada de carbono
- Instalación de placas fotovoltaicas en los principales centros productivos  
Instalação de painéis fotovoltaicos nos principais centros de produção
- Un 30% de referencias con certificación medioambiental  
30% das referências com certificação ambiental



# Brand Corner



350 M\$



15  
Centros de  
producción  
Locais de  
produção



2000  
Empleados  
Empregados



+140  
Países con proyectos  
LedsC4  
Países com  
projectos LedsC4

[www.brandcorner.es](http://www.brandcorner.es)

LedsC4 pertenece al grupo industrial Brand Corner, sello dinámico, con un núcleo familiar y emprendedor fundado en 1987, que cuenta con gran presencia internacional y una visión de negocio global.

Brand Corner cuenta con un equipo internacional de más de 1500 profesionales que desarrollan proyectos en todo el mundo, reuniendo empresas que operan en sectores tan diversos como la iluminación, el mueble, la construcción, el pequeño electrodoméstico, packaging, sistemas de seguridad, equipamiento sanitario, gas y petróleo, inyección de plástico y envasados.

A LedsC4 pertence ao grupo industrial Brand Corner, selo dinâmico, com um núcleo familiar e empresarial fundado em 1987, com uma forte presença internacional e uma visão de negócio global.

Brand Corner possui uma equipa internacional de mais de 1500 profissionais que desenvolvem projetos em todo o mundo, reunindo empresas que operam em setores tão diversos como a iluminação, o mobiliário, a construção, o pequeno eletrodoméstico, o packaging, os sistemas de segurança, o equipamento sanitário, o gás e o petróleo, a injeção de plástico e embalados.

bover  
barcelona lights

LedsC4

CARANDINI

HORMIPRESA

vmédica

INDOX

FIGUERAS GROUP

Resol

VILAGRASA

b&b  
trends

precintia

ndulados  
carme, s.l.

plasfur



# Smart Lighting





# Beneficios del control y la conectividad

## Beneficios del control y la conectividad

La iluminación es un elemento clave para la actividad y el bienestar de las personas. Por ello, en LedsC4 diseñamos luminarias y sistemas de conectividad pensando en cómo interactúan con su entorno. La evolución de la tecnología nos permite maximizar los beneficios para las personas, los edificios y las organizaciones.

A iluminação é um elemento fundamental para a atividade e o bem-estar das pessoas. Por isso, na LedsC4 concebemos luminárias e sistemas de conectividade a pensar na forma como estas interagem com o seu ambiente. A evolução da tecnologia permite-nos maximizar os benefícios para as pessoas, os edifícios e as organizações.



Luminarias  
Luminárias



Sensores e Interfaces  
Sensores e Interfaces

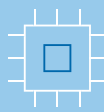

Sistema de control  
y conectividad  
Sistema de controlo  
e conectividade



Cloud / Plataforma  
Cloud / Plataforma



Servicios digitales  
Serviços digitais





# 1

Potencia el bienestar de las personas

Potencia o bem-estar das pessoas

Adapta la iluminación según los ritmos biológicos de las personas, o las necesidades funcionales del espacio. Adapta a iluminação de acordo com os ritmos biológicos das pessoas ou com as necessidades funcionais do espaço.

# 2

Favorece una gestión eficiente del espacio y un ahorro energético

Promove uma gestão eficiente do espaço e a poupança de energia

Recopila información de la instalación, permitiendo planificar, adaptar y mejorar los recursos disponibles. Recolhe informação da instalação, permitindo planear, adaptar e melhorar os recursos disponíveis.

# 3

Impulsa tu organización y mejora la experiencia de los usuarios

Impulsiona a sua organização e melhora a experiência dos utilizadores

Crea espacios flexibles y dinámicos, que se conviertan en una herramienta más de comunicación, mejorando la percepción de los usuarios en el espacio. Cria espaços flexíveis e dinâmicos que se tornam mais um instrumento de comunicação, melhorando a percepção dos utilizadores no espaço.



# Funcionalidades

# Funcionalidades



## Atmósferas y Well-being

## Ambiente e bem-estar

Crea infinitas atmósferas y consigue un entorno flexible y dinámico.  
Cria ambientes infinitos e consegue um ambiente flexível e dinâmico.



## Gestión de color

## Gestão de cor

Transmite emociones a través del espacio gracias a la gestión del color.  
Transmite emoções através do espaço graças à gestão de cor.



## Ahorro energético

## Poupança energética

Comprende las diferentes estrategias para maximizar la eficiencia energética.  
Comprende as diferentes estratégias para maximizar a eficiência energética.



## Gestión de espacios

## Gestão de espaços

Gestiona mejor el uso del espacio y optimiza todos tus recursos.  
Faz uma melhor gestão a utilização do espaço e otimiza todos os seus recursos.



## Mantenimiento preventivo

## Manutenção preventiva

Conoce el estado de las luminarias para asegurar un buen funcionamiento y conservación futura.  
Tem informação sobre o estado das luminárias para assegurar o seu bom funcionamento e manutenção futura.



Nos adaptamos a cualquier necesidad lumínica, independientemente del espacio, para poder ofrecer soluciones únicas y acercar los beneficios del control y la conectividad a nuestros clientes.

Adaptamo-nos a qualquer necessidade lumínica, independentemente do espaço, para poder oferecer soluções únicas e aproximar os benefícios do controlo e da conectividade aos nossos clientes.



**Festival Grec**, Barcelona 2022.  
Fotógrafo: Jordi Anguera



# Atmósferas lumínicas y Well-being

## Ambientes lumínicos e Well-being



Con un sistema de control de iluminación y la posibilidad de regular la intensidad o la temperatura de color de las luminarias (Tunable White), el espacio cobra una mayor flexibilidad y dinamismo para adaptarse a necesidades cambiantes.

Com um sistema de controlo da iluminação e a possibilidade de regular a intensidade ou a temperatura da cor das luminárias (Tunable White), o espaço torna-se mais flexível e dinâmico para se adaptar às necessidades cambiantes.



### Induver Offices, Project Nekton

Luminarias Infinite Up & Down con tecnología TW + Sensor + Casambi Ready, capaces de adaptar la tonalidad de color a cada hora del día siguiendo el ciclo circadiano.

Luminárias Infinite Up & Down com tecnologia TW + Sensor + Casambi Ready, capazes de adaptar a tonalidade de cor a cada hora do dia seguindo o ciclo circadiano.



### CNTEC, Girona 2020.

Luminarias DALI controladas mediante un sistema DALI2 que permite obtener máxima flexibilidad del espacio según uso.

Finelight DALI controladas por um sistema DALI2 que permite obter a máxima flexibilidade do espaço de acordo com a utilização.

**Brondesbury Park Sinagogue, London 2022.**  
 Ampla variedade de luminarias que, con un sistema de control Casambi, generan diferentes atmósferas en función del uso del espacio y de las festividades.  
 Ampla variedade de luminárias que, com um sistema de controlo Casambi, geram atmosferas diferentes dependendo da utilização do espaço e das festividades.



**Elige la opción más adecuada a tu proyecto**

**Escolha a opção mais adequada ao seu projeto**

- ① Standalone
- ② Casambi
- ③ DALI2

①

②

③

- Control color RGB o RGBW  
Controlo cor RGB ou RGBW
- Regulación TW (2700K 6500K)  
Regulação TW (2700K 6500K)
- Encendido por presencia  
Acendimento por presença
- Regulación por luminosidad  
Regulação por luminosidade
- Control vía APP  
Controlo via APP
- Escenas lumínicas  
Cenas lumínicas
- Ciclo Circadiano  
Ciclo Circadiano
- Programaciones horarias y calendario  
Programações horárias e calendário
- Integrable vía API  
Integrável via API
- Integrable BMS vía BACnet  
Integrável BMS via BACnet



# Gestión de color

## Gestão de cor



El color es el mejor vehículo para transmitir emociones. Un espacio con colores es capaz de generar sensaciones. Dotar a los espacios de color, los hace ser más flexibles, que puedan cambiar según el objetivo de comunicación o el contexto de instalación, y hacer sentir un sinfín de sensaciones mediante un sistema de control de LedsC4. A cor é o melhor meio para transmitir emoções. Um espaço com cores é capaz de gerar emoções e fazer com que as pessoas que nele se encontram as sintam. Dar cor aos espaços torna-os mais flexíveis, para que possam mudar de acordo com o objetivo de comunicação ou o contexto de instalação e tudo isto através de um sistema de controlo da LedsC4.

### Llum BCN, Barcelona 2022.

Luminarias especiales con tecnología Casambi Ready que permiten seleccionar el color ideal para el proyecto.

Luminárias especiais com tecnologia Casambi Ready que permite seleccionar a cor ideal para o projeto.

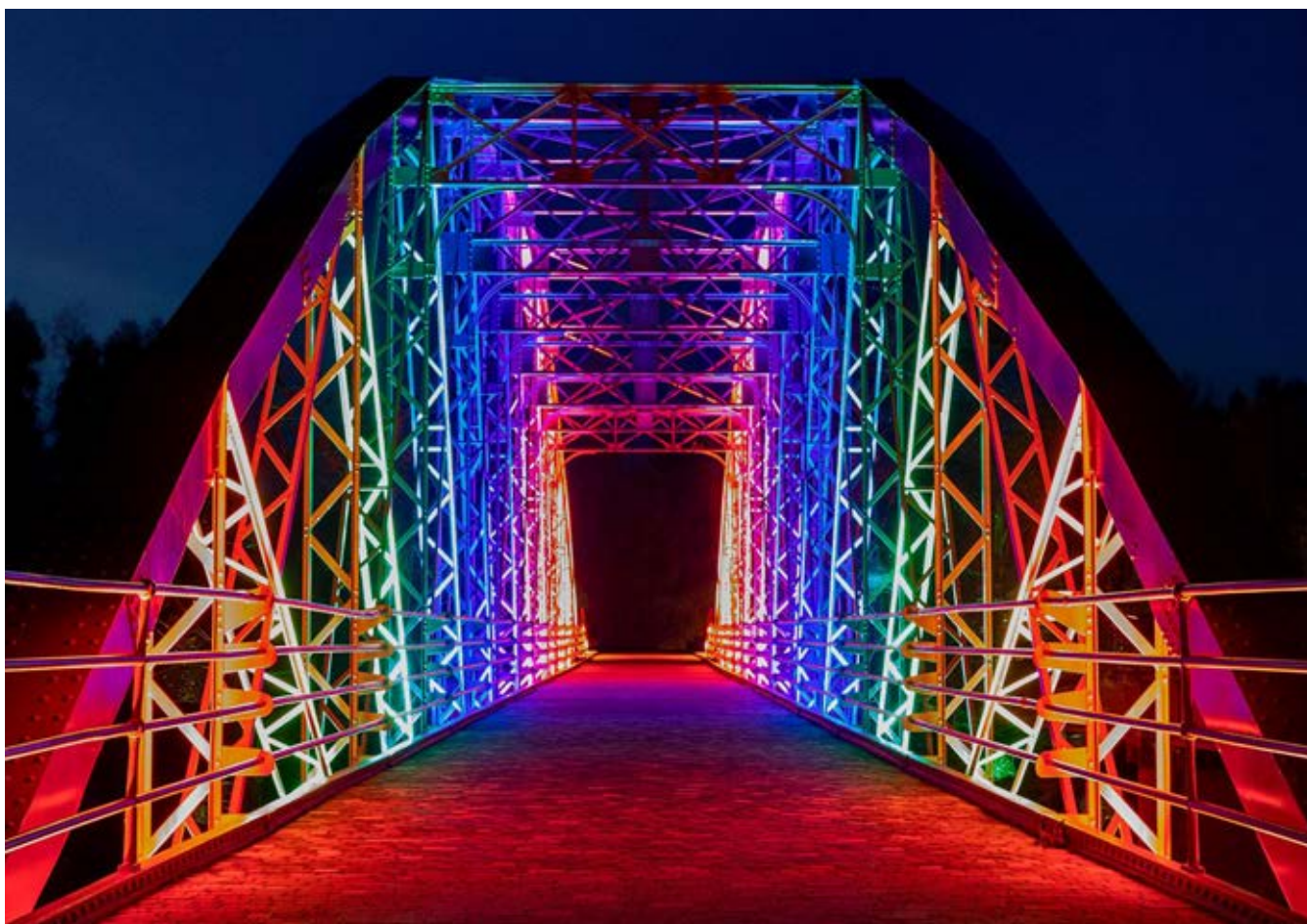

### Puente de los Remedios, Villafranca de Cordoba 2022.

Proyecto de iluminación y control DMX de LedsC4. Gracias al servicio On site, técnicos de LedsC4 asesoraron durante las diferentes fases del proyecto y configuraron la iluminación para obtener diferentes escenas en función de las festividades del año.

Projeto de iluminação e controlo DMX da LedsC4. Graças ao serviço On site, os técnicos da LedsC4 aconselharam durante as diferentes fases do projeto e configuraram a iluminação para obter diferentes cenas em função das festividades do ano.



#### Hotel Galua, Murcia 2021.

Proyecto entregado gracias al servicio Ready To con tecnología Casambi. El cliente recibió las luminarias configuradas con las escenas solicitadas, así simplemente tuvo que instalarlas y acceder a la aplicación para lanzarlas.

Projeto entregue graças ao serviço Ready To com tecnologia Casambi. O cliente recebeu as luminárias configuradas com as cenas solicitadas, pelo que teve apenas de as instalar e aceder à aplicação para ligá-las.

#### Elige la opción más adecuada a tu proyecto

Escolha a opção mais adequada ao seu projeto

① Standalone

② Casambi

③ DMX

①

②

③

- Escenas y secuencias lumínicas  
Cenas e sequências lumínicas
- Control color RGB o RGBW  
Controlo cor RGB ou RGBW
- Control vía botonera de pared  
Controlo via botoneira de parede
- Programaciones horarias y calendario  
Programações horárias e calendário
- Control remoto instalación  
Controlo remoto instalação
- Control vía APP bluetooth  
Controlo via APP bluetooth
- Control punto a punto de las luminarias  
Controlo ponto a ponto das luminárias



# Ahorro energético

## Poupança energética



**Institut Vilablareix, Girona 2022.**

Luminarias Infinite con Sensor autónomo Stand Alone, configurado con el servicio Ready To, según las necesidades de control por presencia del cliente.

Luminárias Infinite com Sensor autónomo Stand Alone, configurado com o serviço Ready To, segundo as necessidades de controlo por presença do cliente.

La reducción del consumo energético se logra gracias al binomio de una iluminación eficiente y un sistema de control. Son sistemas que permiten recopilar datos y establecer estrategias de ahorro basadas en la ocupación y un mayor aprovechamiento de la luz natural y de los recursos disponibles.

A redução do consumo energético é alcançada através da combinação de uma iluminação eficiente e um sistema de controlo. Sistemas que permitem a recolha de dados e estabelecer estratégias de poupança baseadas na ocupação e um maior aproveitamento da luz natural e dos recursos disponíveis.

### Estrategias de ahorro energético:

### Estratégias de poupança energética:

- Iluminación regulable y ajustable según las necesidades de la persona o situación. Ahorro hasta un 20%  
Iluminação regulável e ajustável de acordo com as necessidades da pessoa ou situação. Poupança até 20%
- Control por ocupación. Encendido de varios niveles de regulación en función de la ocupación o ausencia. Ahorro hasta un 30%  
Controlo por ocupação. Comutação entre vários níveis de regulação, dependendo da ocupação ou ausência. Poupança até 30%
- Regulación por control de luz constante en función de la entrada de luz natural. Ahorro hasta un 30%  
Regulação por controlo constante da luz, dependendo da quantidade de luz natural que entra. Poupança até 30%



**Loom, Barcelona 2020-2022.**

Control de iluminación D4i. Intensidad 80%. Escena con ocupación.  
Controle de iluminação D4i. Intensidade 80%. Cena com ocupação.



Intensidad 25%. Escena sin ocupación.  
Intensidade 25%. Cena sem ocupação.





Iberspa, 2022.  
Control de iluminación Casambi. Franja horaria diurna.  
Controlo de iluminação Casambi. Intervalo horário diurno.



Franja horaria nocturna  
Intervalo horário noturno

### Elige la opción más adecuada a tu proyecto

Escolha a opção mais adequada ao seu projeto

① Standalone

② Casambi / DALI2

③ D4i

①

- Regulación según ocupación  
Regulação segundo ocupação
- Regulación según nivel de luz natural  
Regulação segundo o nível de luz natural
- Escenas estáticas y reproducción de escenas en movimiento  
Cenas estáticas e reprodução de cenas em movimento
- Programaciones horarias y de calendario  
Programações horárias e de calendário

②

- Control remoto de la instalación  
Controlo remoto da instalação
- Integrable BMS vía BACnet  
Integração de BMS via BACnet
- Integrable vía API  
Integrável via API
- Recopilación de datos de ocupación  
Recompilação de dados de ocupação
- Mantenimiento preventivo  
Manutenção preventiva

③

- Gráficos de ahorro energético  
Gráficos de poupança de energia

# Gestión de espacio

## Gestão do espaço

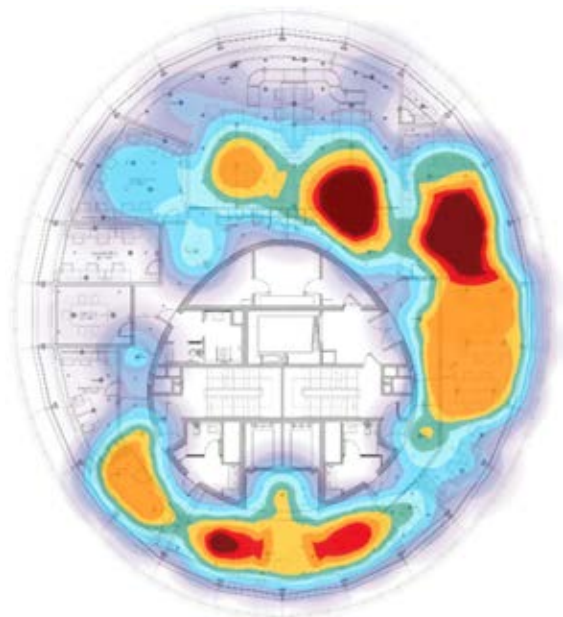

Para aumentar la eficiencia de una instalación y así del negocio, es fundamental gestionar y controlar el uso del espacio.

Para aumentar a eficiência de uma instalação e, por isso, do negócio, é essencial gerir e controlar a utilização do espaço.



Infinite con sensor D4i capaz de captar información del uso del espacio.

Infinite Pro com sensor D4i capaz de captar informação sobre a utilização do espaço.

### Estrategias para la gestión de los espacios:

#### Estratégias para a gestão dos espaços:

- Obtener mapas de calor para conocer las zonas más o menos transitadas  
Obter mapas de calor para conhecer as zonas mais ou menos transitadas
- Visibilizar las rutas más utilizadas y los desplazamientos de los usuarios  
Visibilizar os percursos mais utilizados e as deslocações dos utilizadores
- Conocer el estado de los puestos de trabajo  
Conhecer o estado dos postos de trabalho

### Estas estrategias permiten:

#### Estas estratégias permitem:

- Aprovechar al máximo los espacios de una organización y determinar las necesidades reales  
Aproveitar ao máximo os espaços de uma organização e determinar as necessidades reais
- Conocer los hábitos de los usuarios  
Conhecer os hábitos dos utilizadores
- Adoptar campañas o estrategias de comunicación en función de las zonas más transitadas.  
Adotar campanhas ou estratégias de comunicação de acordo com as zonas mais transitadas



**Loom**, Torre Glorías Barcelona 2020-2022.

Luminarias Infinite con sensor D4i incorporado que permite maximizar la eficiencia energética del espacio al funcionar en función de la presencia y la luminosidad natural.

Luminárias Infinite com sensor D4i incorporado que permite maximizar a eficiência energética do espaço ao funcionar em função da presença e da luminosidade natural.

**Elige la opción más adecuada a tu proyecto**

**Escolha a opção mais adequada ao seu projeto**

① D4i

② D4i + Space Service

③ D4i + Where Service

- Escenas lumínicas  
Cenas lumínicas
- Encendido por presencia  
Acendimento por presença
- Regulación por luminosidad  
Regulação por luminosidade
- Control vía botonera de pared  
Controlo via botoneira de parede
- Programaciones horarias y calendario  
Programações horárias e calendário
- Control remoto instalación  
Controlo remoto instalação
- Monitorización de la energía  
Monitorização da energia
- Mantenimiento preventivo  
Manutenção preventiva
- Obtención de mapas de calor  
Obtenção de mapa de calor
- Integración vía BACnet  
Integração via BACnet
- Integrable via API  
Integrável via API

①

**Space Service:**

- Índices de utilización por zonas  
Índices de utilização por zonas
- Rutas de desplazamiento de los usuarios  
Percurso e deslocações dos utilizadores

②

**Where Service:**

- Servicio de identificación y ubicación de activos  
Serviço de identificação e localização de ativos

③

# Mantenimiento preventivo

## Manutenção preventiva

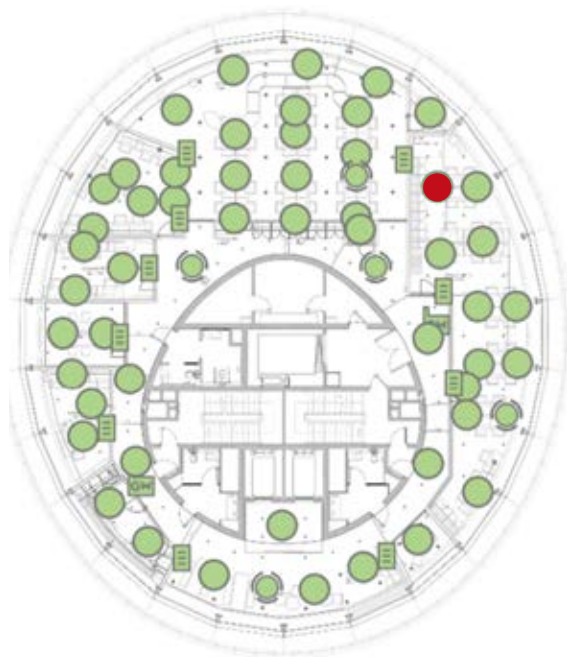

Un seguimiento activo de la información obtenida a partir de las luminarias nos permite conocer el estado y la durabilidad de las luminarias, detectar incidencias y realizar revisiones de los equipos e instalaciones con el fin de garantizar un buen funcionamiento y conservación futura.

O seguimento ativo da informação obtida a partir das luminárias permite-nos saber o estado e a durabilidade das luminárias, detetar incidências e realizar verificações dos equipamentos e instalações para garantir um bom funcionamento e conservação futura.

**Elige la opción más adecuada a tu proyecto**  
**Escolha a opção mais adequada ao seu projeto**

① DALI2

② D4i

①

- Comprobación del estado de las luminarias  
Verificação do estado das luminárias
- Comprobación de equipos y sensores  
Verificação dos equipamentos e sensores
- Revisión del estado de las luminarias de emergencia  
Análise do estado das luminárias de emergência
- Copia de seguridad de la instalación  
Cópia de segurança da instalação
- Generación de alarmas de funcionamiento anómalo  
Geração de alarmes de funcionamento anómalo
- Conocimiento de la temperatura de los drivers  
Conhecimento da temperatura dos drivers

②

- Resumen de las horas de funcionamiento de luminarias y su consumo  
Resumo das horas de funcionamento das luminárias e do seu consumo



**CNTEC**, Girona 2020.

Centro de estudios, donde se busca el control centralizado de todo el espacio, permitiendo conocer el estado de las luminarias.

Centro de estudos, onde se procura o controlo centralizado de todo o espaço, permitindo conhecer o estado das luminárias.

Fotógrafo: Jordi Anguera

# The LedsC4 Lighting Experience

Servicios  
Serviços

Vive la experiencia LedsC4, descubre todos los servicios que tenemos a tu disposición para hacer realidad tu proyecto y durante todas las fases del mismo.

Viva a experiência LedsC4 e descubra todos os serviços que temos à sua disposição durante todas as fases do seu projeto para torná-lo uma realidade.



+ Servicios / Serviços

# 1

## Pre-Venta Pré-Venda

Idea y conceptualización  
Ideia e conceptualização



# 2

## Venta Venda

Ejeccción y entrega  
Execução e entrega



### Consultoria y asesoramiento Consultoria e assessoramento

- Concepto lumínico  
Conceito lumínico
- Cálculo luminotécnico  
Cálculo luminotécnico
- Propuesta de control  
Proposta de controlo
- Propuesta arquitectónica  
Proposta arquitetónica
- Estudio de ahorro energético  
Estudo de poupança energética
- Esquemas eléctricos  
Esquemas elétricos
- Diseño de luminarias especiales  
Design de luminárias especiais

### Gestión del proyecto Atención técnica Gestão do projeto Assistência técnica

Te ayudamos a transformar tecnológicamente tu espacio, gracias a los servicios de asesoramiento en obra.  
Ajudamo-lo a transformar tecnológicamente o seu espaço, graças aos serviços de aconselhamento em obra.

#### Ready to:

Configuración y precomisionado de equipos de control y conectividad en fábrica.  
Configuração e pré-comissionamento dos equipamentos de controlo e conectividade na fábrica.

#### On site:

Asesoramiento y configuración de equipos de iluminación y control en obra.  
Aconselhamento e configuração dos equipamentos de iluminação e controlo em obra





Cuenta siempre con el soporte de nuestro equipo de profesionales expertos en iluminación  
Conte sempre com o apoio da nossa equipa de profissionais especialistas em iluminação

# 3

## Post-Venta Post-Venda

Mantenimiento y optimización  
Manutenção e otimização



### Planes de acompañamiento anual Planos anuais de acompanhamento

Te acompañamos durante el ciclo de vida de tu instalación para que le saques el máximo rendimiento a nivel de confort para las personas y de eficiencia energética.

Acompanhamo-lo durante todo o ciclo de vida da sua instalação para que possa tirar o máximo partido dela em termos de conforto pessoal e eficiência energética.

- **Plan Essential**
- **Plan Performance**
- **Plan Advanced**

# 4

## Servicios Digitales Serviços Digitais

Gestión de datos  
Gestão de dados



### Mantenimiento preventivo Manutenção preventiva

Conoce el estado de las luminarias para asegurar un buen funcionamiento y conservación futura.

Tem informação sobre o estado das luminárias para assegurar o seu bom funcionamento e manutenção futura.

### Gestión de espacios Gestão de espaços

Gestiona mejor el uso del espacio y optimiza todos tus recursos.

Faz uma melhor gestão da utilização do espaço e otimiza todos os seus recursos.

### Gestión de activos Gestão de ativos

Monitorización de la ubicación de determinados objetos y gestión de alarmas.

Monitorização da localização de determinados objetos e gestão de alarmes.

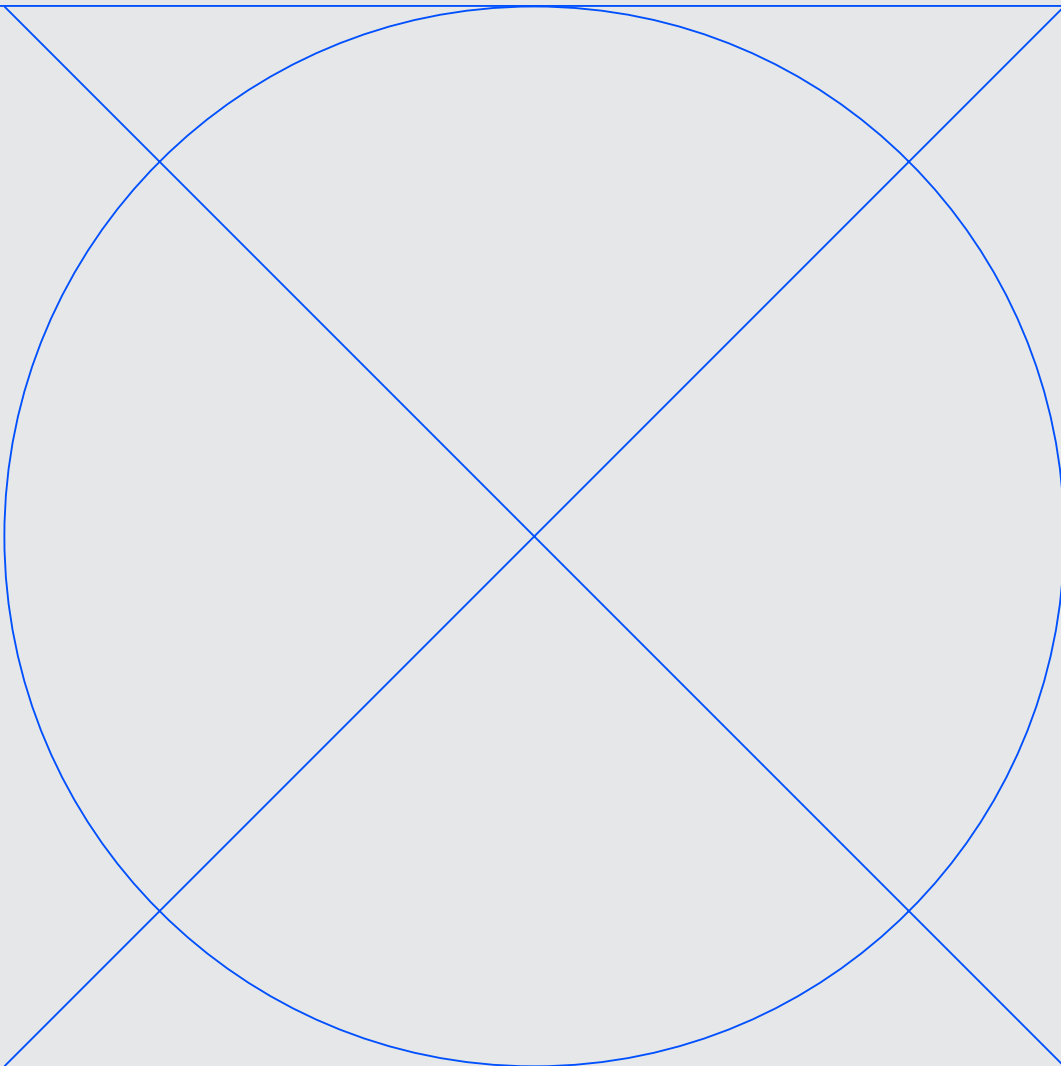

Indoor



022

Indoor  
Collections



076

Proyectors / Carriles  
Projetores / Calhas

LV

110

Bajo Voltaje  
Baixa Tensão



160

Downlights



280

Colgantes / Apliques  
Suspensões / Apliques



296

Proyectors / Plafones  
Projetores / Plafons

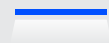

342

Sistemas Lineales  
Sistemas Lineares



424

Tiras LED  
Fitas LED



450

Señalización  
Sinalização

# Indoor Collections

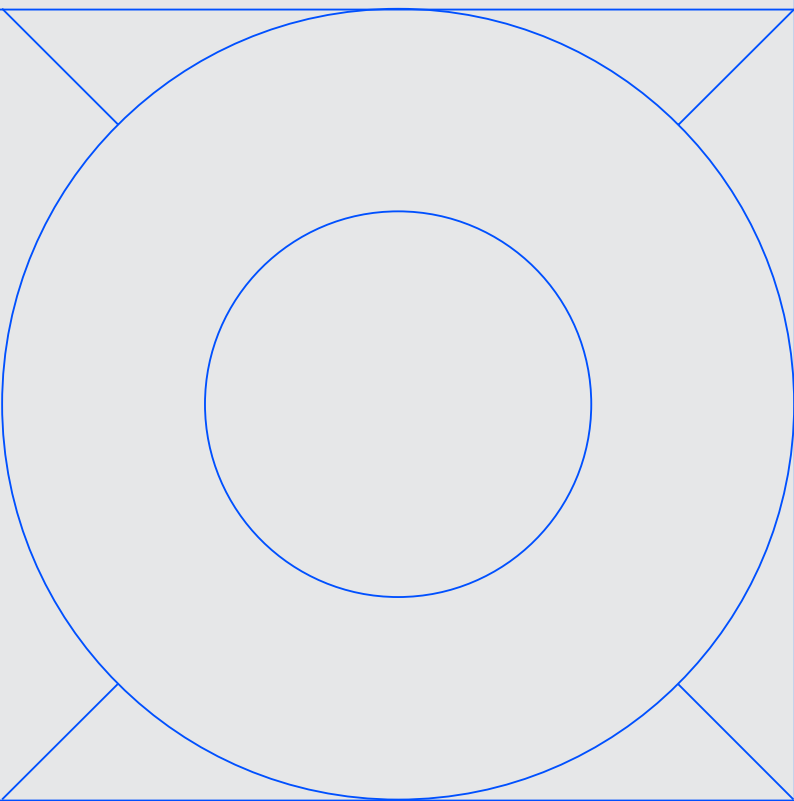

Atom  
024

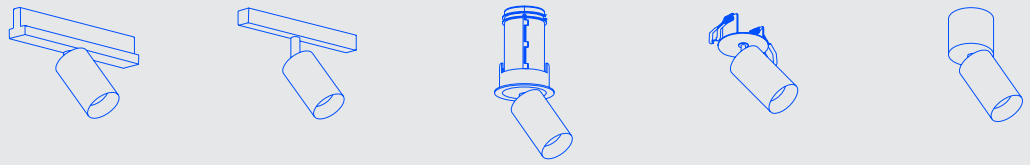

Iris  
034

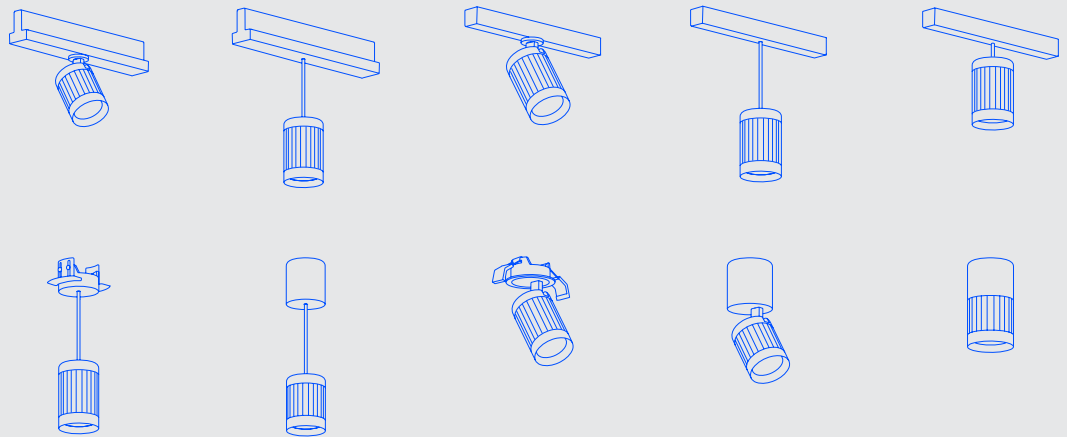

Bento  
050

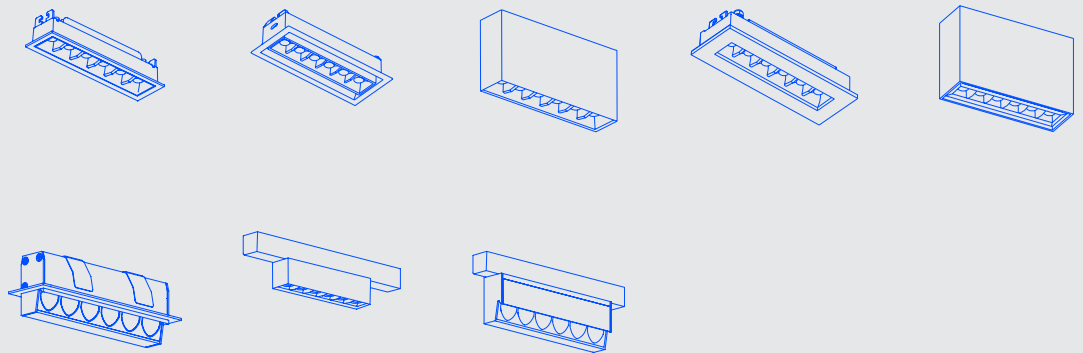

Luno Slim  
062

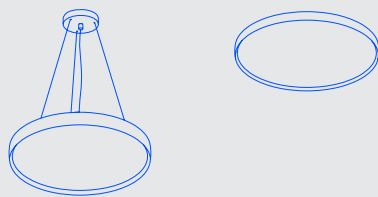

Multidir Evo  
068



Kiva  
072



# Atom

Designed by LedsC4 Architectural



+ Atom



Atom es tan versátil que puede adaptar su tamaño y acabado al ritmo de los ambientes que habita, respetando la armonía del espacio. Sus soluciones técnicas aportan un óptimo control en todo el rango de ángulos garantizando un alto confort visual.

Atom é tão versátil que pode adaptar o seu tamanho e acabamento ao ritmo dos ambientes que habita, respeitando a harmonia do espaço. As suas soluções técnicas proporcionam um controlo ótimo em toda a gama de ângulos, garantindo um alto conforto visual.

Diseño cilíndrico y  
proporciones armónicas  
Design cilíndrico e  
proporções harmoniosas





Proyectores  
**Atom Track**

**078**

Low Voltage  
**Atom Low Voltage**

**116**

Downlight  
**Atom Hide**

**326**

Plafones  
**Atom Recessed**

**332**

Plafones  
**Atom Surface**

**320**

Ø 30 mm



○ ● ● ●  
14 60 81 DN

Ø 32 mm



○ ●  
14 60

Ø 30 mm



○ ● ● ● ●  
14 60 81 DN

Ø 52 mm



○ ●  
14 60

Ø 52 mm



○ ● ● ● ●  
14 60 81 DN

Ø 52 mm



○ ● ● ● ●  
14 60 81 DN

Ø 52 mm



○ ● ● ● ●  
14 60 81 DN

Ø 52 mm



○ ● ● ● ●  
14 60 81 DN

Ø 75 mm



○ ●  
14 60

Ø 78 mm



○ ●  
14 60

Ø 75 mm



○ ●  
14 60

Ø 97 mm



○ ●  
14 60

7.5 - 37.3W



Ultraspot 8° -  
Ultraflood 49°

3.1 - 15W



Ultraspot 8° -  
Ultraflood 47°

3.1 - 24W



Ultraspot 8° -  
Ultraflood 47°

3.1 - 12.1W



Ultraspot 8° -  
Ultraflood 47°

7.5 - 24W



Ultraspot 8° -  
Ultraflood 47°





Diferentes opciones de instalación  
en una misma colección  
Diferentes opções de instalação  
numa mesma coleção

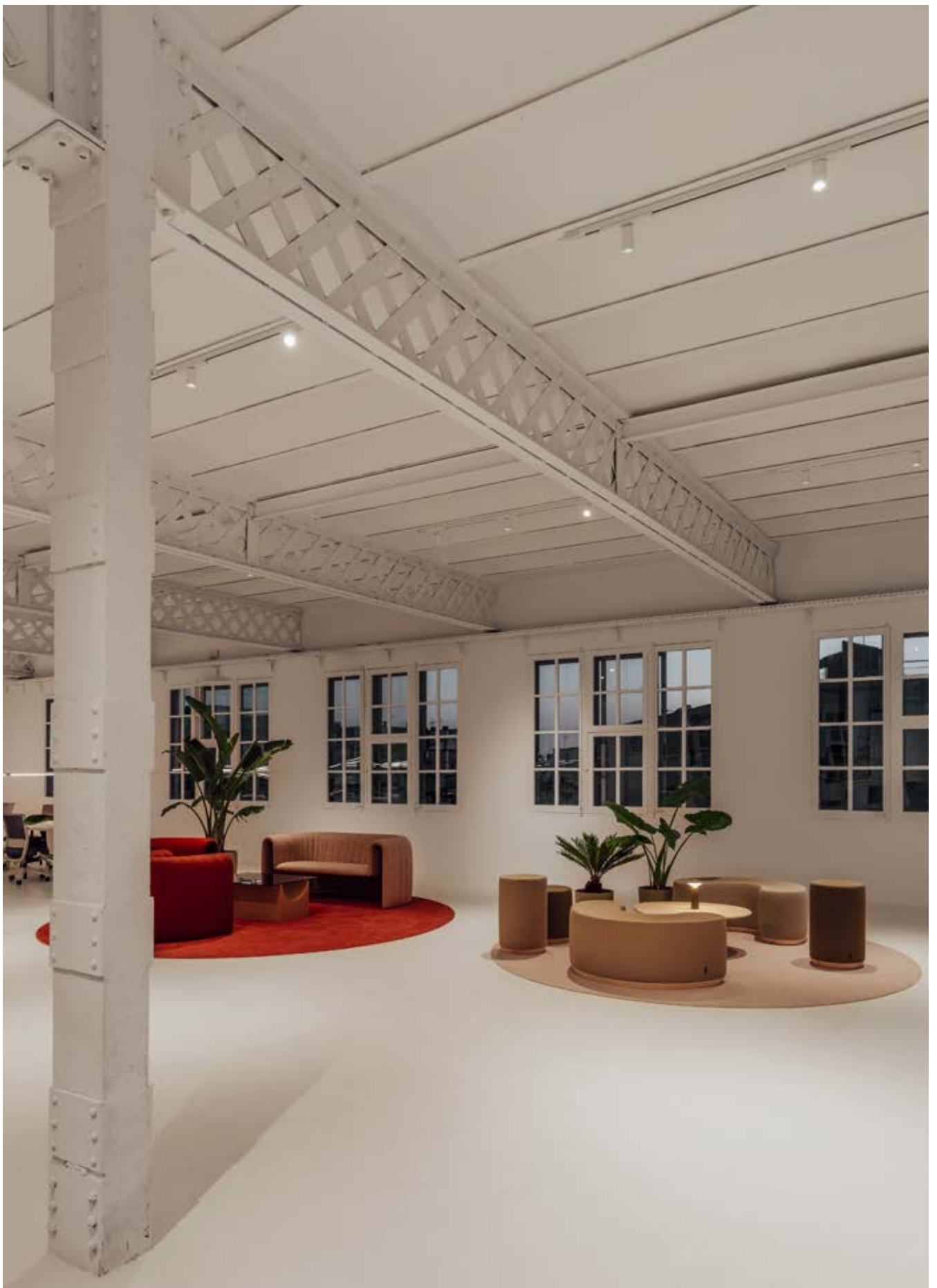

**Atom Track 52** en Proyecto Estudio Fuego Camina Connigo. Barcelona. Fotografía: Enric Badrinas.  
**Atom Track 52** no Projeto Estudio Fuego Camina Connigo. Barcelona. Fotografía: Enric Badrinas.

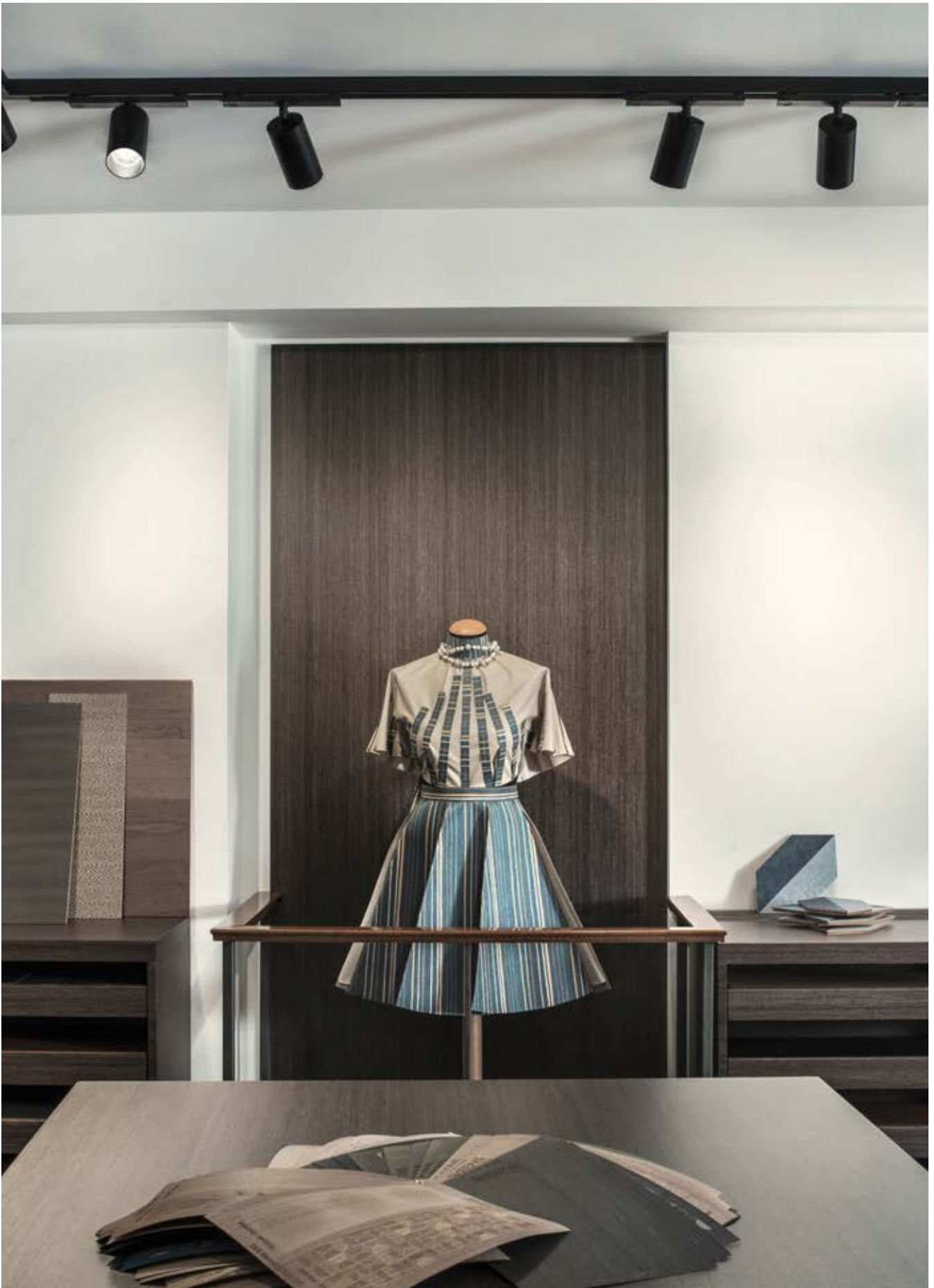







## Eficiencia y confort visual

## Eficiência e conforto visual

Gracias a un desarrollo específico para la lente combinado con un LED de alta eficiencia, Atom ofrece entre sus opciones un ángulo de tan sólo 8° de apertura. El resultado es una luz de acento con contornos suaves y uniformes.

Graças a um desenvolvimento específico para a lente combinado com um led de alta eficiência, Atom oferece entre as suas opções um ângulo de apenas 8° de abertura. O resultado é uma luz de realce com contornos suaves e uniformes.



Ángulo controlado de 8°  
8° ângulo controlado

INDOOR

INDOOR COLLECTIONS



## Zoom manual

## Zoom manual

Sistema que permite controlar el ángulo de apertura del haz de luz pasando de 16° a 47° de forma rápida y cómoda.

Sistema que permite controlar o ângulo de abertura do feixe de luz de 16° a 47° de forma rápida e cómoda.

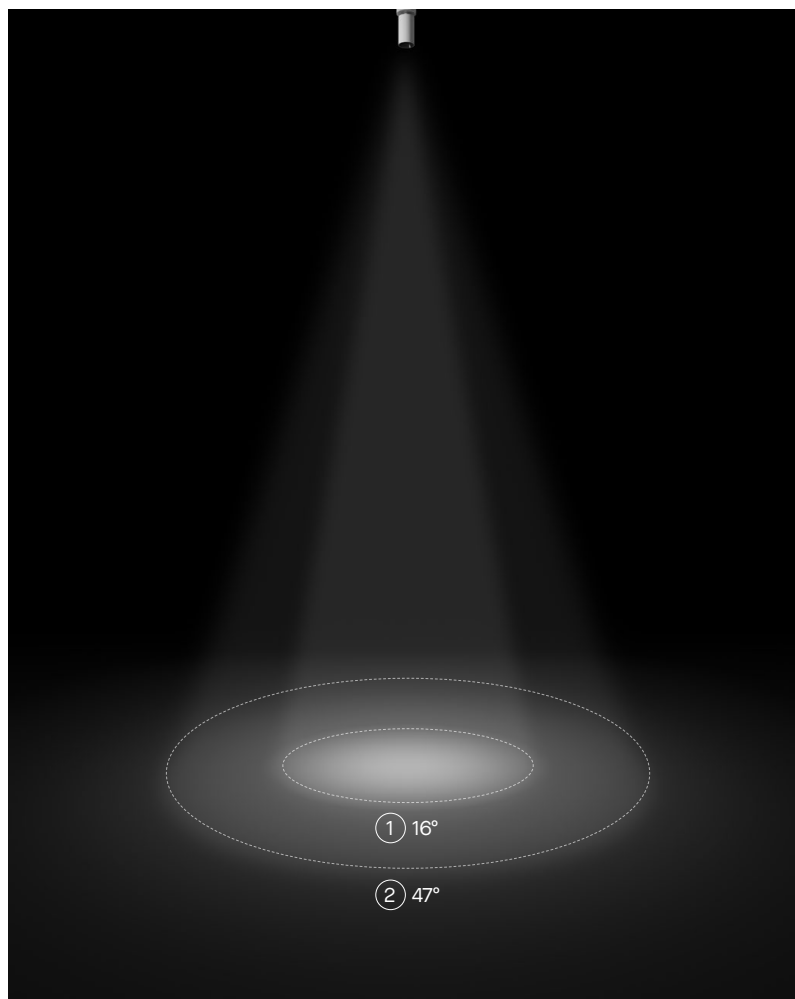

Accesorios para embellecer la pieza,  
maximizar el confort o modular la luz  
Acessórios para embelezar a peça,  
maximizar o conforto ou modular a luz

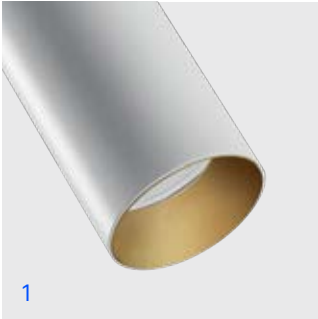

1. Aro embellecedor dorado  
Aro embelezador dourado
2. Aro embellecedor negro  
Aro embelezador preto
3. Aro embellecedor blanco  
Aro embelezador branco
4. Confort visual  
Conforto visual
5. Visera  
Viseira



1. Panel de abeja  
Painel de abelha
2. Difuminador de halo  
Difusor opalino
3. Difusor elíptico  
Difusor elíptico

# Iris

Designed by Artec Studio



+ Iris



Arquitectural y decorativa a la vez, Iris es una colección orgánica y viva, que dialoga activamente creando diferentes ambientes y mejorándolos con su presencia a través de la luz y la percepción visual de su estructura. Sus opciones de adaptación al espacio y composición son tan amplias que forman un círculo de creación en perfecta armonía.

Arquitetural e decorativa ao mesmo tempo, Iris é uma coleção orgânica e viva que dialoga ativamente, criando diferentes ambientes e valorizando-os com a sua presença através da luz e da percepção visual da sua estrutura. As suas opções de adaptação ao espaço e composição são tão amplias que formam um círculo de criação em perfeita harmonia.

Así como el iris ocular se ensancha y se contrae para adaptarse a la luz, Iris modula su cuerpo y alma para adaptarse a los espacios que habita, mejorándolos  
Assim como a íris ocular se expande e se contrai para se adaptar à luz, Iris modula o seu corpo e alma para se adaptar aos espaços que habita, melhorando-os



**Iris** respeta el concepto y el valor de los espacios, adaptándose en cuerpo y alma, con forma y luz, dialogando de forma activa con los ambientes que ilumina.

**Iris** respeita o conceito e o valor dos espaços, adaptando-se de corpo e alma, com a forma e a luz, dialogando de forma ativa com os ambientes que ilumina.





**Alma con carácter.** Las diferentes ópticas de Iris consiguen que su luz se moldee según las necesidades del espacio, para enfatizar productos o generar áreas de confort y calidez.

**Alma com carácter.** As diferentes óticas de Iris permitem que a sua luz seja moldada de acordo com as necessidades do espaço, para enfatizar produtos ou gerar áreas de conforto e calidez.



Diferentes composiciones en una misma colección  
Diferentes composições na mesma coleção



**Equilibrio perfecto entre funcionalidad, calidad y calidez.** Gracias a las diferentes combinaciones de vidrios, acabados y composiciones, la luz de Iris genera sensaciones, por eso es ideal para espacios corporativos donde la percepción y las emociones son la base de la comunicación.

**Equilíbrio perfeito entre funcionalidade, qualidade e calidez.** Graças às diferentes combinações de vidros, acabamentos e composições, a luz de Iris gera sensações, tornando-a ideal para espaços corporativos onde a percepção e as emoções são a base da comunicação.





**Calidad cromática y confort visual.** Accesorios y componentes como confort visual componen una pieza muy técnica que es capaz de potenciar la gama cromática de los productos que ilumina con un CRI90, por lo que su uso es muy adecuado para espacios como galerías de arte o concept stores.

**Qualidade cromática e conforto visual.** Acessórios e componentes como conforto visual compõem uma peça muito técnica capaz de potenciar a gama cromática dos produtos que ilumina com um CRI90, tornando-a altamente adequada para espaços como galerias de arte ou concept stores.





## La magia del vidrio A magia do vidro



Transparencias insinadoras  
cuando está encendida.  
Transparência insinuante  
quando ativada.

Iris transmite sensaciones tanto encendida como apagada. La textura especial de los componentes de vidrio, sopladados con un tratamiento especial, provocan un efecto espejo cuando está apagada y unas transparencias insinuadoras cuando la luz rebota en el difusor.

Iris transmite sensações tanto ligada como desligada. A textura especial dos componentes de vidro, soprados com um tratamento especial, cria um efeito de espelho quando está desligada e umas transparências insinuadoras quando a luz ressalta no difusor.



Efecto espejo cuando está apagada.  
Efeito espelho quando desligada.

## Armonía en el espacio Harmonia no espaço

Camaleónica y sugerente. Los componentes de Iris son especiales y todos presentan una personalidad diferente en base a su cuerpo y alma, que son la luz y sus formas. La percepción varía según el punto de vista desde el que se observen o la incidencia de la luz natural sobre su superficie.

Camaleónica e sugestiva. Os componentes de Iris são especiais e todos têm uma personalidade diferente com base no seu corpo e alma, que são a luz e as suas formas. A percepção varia de acordo com o ponto de vista a partir do qual são observados ou a incidência de luz natural na sua superfície.



# Precisión Precisão



Iris se desarrolla en fábrica con la técnica grafilat, que consiste en un marcaje artesanal de alta tecnificación. Todo el proceso se desarrolla con un cuidado especial por los detalles.

Iris é desenvolvida na fábrica utilizando a técnica de grafilat, que consiste na marcação artesanal altamente técnica. Todo o processo é realizado com especial atenção aos detalhes.

## Producto sostenible Produto sustentável



### Eficiencia Energética Eficiência energética

La composición de la pieza favorece la disipación térmica y permite ajustar el consumo regulando la intensidad luminosa.  
A composição da peça favorece a dissipação térmica e permite ajustar o consumo regulando a intensidade luminosa.

### Material reciclable Material reciclável

Utilización de productos reciclables y/o procedentes de fuentes reciclables.  
Utilização de produtos recicláveis e/ou procedentes de fontes recicláveis.

### Diseño sostenible Design sustentável

Fácil recambio del módulo LED y mecanismo de control para aumentar la vida útil del producto.  
Troca fácil do módulo LED e mecanismo de controlo para aumentar a vida útil do produto.

### Segregación de residuos Segregação de resíduos

Iris permite el desmontaje de componentes para facilitar la gestión de residuos.  
Iris permite a desmontagem de componentes para facilitar a gestão de resíduos.

Utilización de materiales reciclables, con componentes reemplazables y con un alto grado de durabilidad  
Utilização de materiais recicláveis, com componentes substituíveis e um elevado grau de durabilidade.



# Módulos / Módulos

6W



12W



18W



# Instalaciones / Instalações

3-Phase Track

Low Voltage Track

Ceiling Surface

Ceiling Remote Driver

Spotlight

AV21

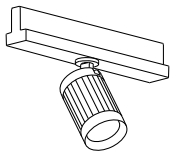

AV19

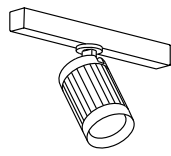

AV13 / AV28

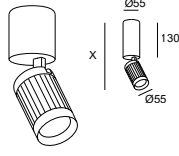

AV11 / AV12

Trim/Trimless

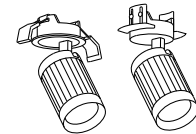

Fixed

AV23

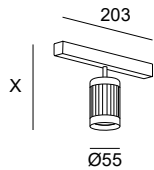

AV17 / AV27

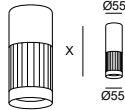

Pendant

AV25

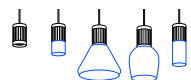
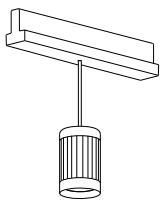

AV24

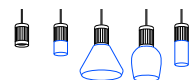
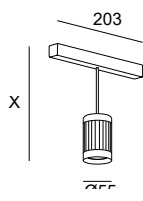

AV16 / AV26

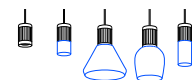
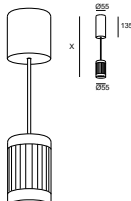

AV14 / AV15

Trim/Trimless

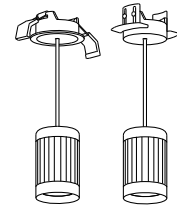

# Frontales / Frontal



Hoop

Visual Comfort

Pipe  
Crystal

Glass  
Crystal

Cone  
Crystal



# Acabados / Acabadmentos

## Módulos / Módulos



## Frontales / Frontal Hoop

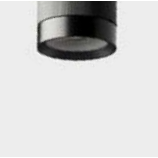

## Frontales / Frontal Crystal



\* Acabados disponibles para todas las opciones de componente de vidrio. / Acabamentos disponíveis para todas as opções de componentes de vidro.

## Frontales / Frontal Visual Comfort



							
	<b>Módulo / Módulo</b>						
	<b>Frontales / Frontal</b>						
<b>Spotlight</b>	<b>AV21</b> 3-Phase Track	L7	60	L8	L9	07	08
	<b>AV19</b> Low Voltage	L7	60	L8	L9	05	06
	<b>AV13</b> Surface Short	L7	60	03	04	09	P7
	<b>AV28</b> Surface Long	L7	60	03	04	09	P7
	<b>AV11</b> Recessed Trim	L7	60	L8 <sup>1</sup> / O1 <sup>2</sup>	L9 <sup>1</sup> / O2 <sup>2</sup>	07	08
	<b>AV12</b> Recessed Trimless	L7	60	L8 <sup>1</sup> / O1 <sup>2</sup>	L9 <sup>1</sup> / O2 <sup>2</sup>	07	08
<b>Fixed</b>	<b>AV23</b> Low Voltage	L7	60	L8	L9	05	06
	<b>AV17</b> Ceiling Surface Short	L7	60	03	04	09	P7
	<b>AV27</b> Ceiling Surface Long	L7	60	03	04	09	P7
<b>Pendant</b>	<b>AV25</b> 3-Phase Track	L7	60	L8 <sup>1</sup> / O1 <sup>2</sup>	L9 <sup>1</sup> / O2 <sup>2</sup>	07	08
	<b>AV24</b> Low Voltage	L7	60	L8	L9	05	06
	<b>AV16</b> Surface Short	L7	60	L8 <sup>1</sup> / O1 <sup>2</sup>	L9 <sup>1</sup> / O2 <sup>2</sup>	07	08
	<b>AV26</b> Surface Long	L7	60	L8 <sup>1</sup> / O1 <sup>2</sup>	L9 <sup>1</sup> / O2 <sup>2</sup>	07	08
	<b>AV14</b> Recessed Trim	L7	60	L8 <sup>1</sup> / O1 <sup>2</sup>	L9 <sup>1</sup> / O2 <sup>2</sup>	07	08
	<b>AV15</b> Recessed Trimless	L7	60	L8 <sup>1</sup> / O1 <sup>2</sup>	L9 <sup>1</sup> / O2 <sup>2</sup>	07	08

\* Acabados disponibles para todos los elementos frontales. / Acabamentos disponíveis para todos os elementos frontais.

<sup>1</sup> Base instalación negra / Base de instalação preta

<sup>2</sup> Base instalación blanca / Base de instalação branca

# Iris

## 1 Instalaciones Instalaciones

- Track
- Low Voltage
- Spotlight
- Pendant
- Ceiling

## 2 Módulo Módulo

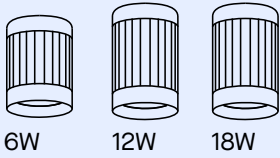

6W      12W      18W

## 3 Lente Lente

2700K | 3000K | 4000K

## 4 Óptica Optica

15° | 35° | 50°

## 5 Accesorios Accesorios



Panel de abeja      Difusor elíptico      Difusor opal      Difusor cuadrado      Screen  
Painel de abelha      Difusor elíptico      Difusor opalino      Difusor quadrado

## 6 Componentes Componentes



Hoop      Visual Confort

Pipe      Cone      Glass





Opciones de configuración infinitas de forma fácil y rápida gracias nuestro configurador online.

Opções de configuração infinitas de uma forma rápida e fácil, graças ao nosso configurador online.



**1** Seleccionar propiedades, instalación, acabados, accesorios y componentes  
Selecione propriedades, instalação, acabamentos, acessórios e componentes

**2** Descarga de documentación  
Descarregar de documentação

# Bento

Designed by LedsC4 Architectural



+ Bento



El grupo óptico de esta colección de downlights está especialmente desarrollado para evitar deslumbramientos y obtener un óptimo control de la luminaria en situaciones exigentes. Con estructura multi-cell y módulos ópticos individuales, Bento es la opción ideal para ambientes donde el confort y la integración debe ser máxima.

O grupo ótico desta coleção de downlights está especialmente desenvolvido para evitar o encandeamento e obter um ótimo controle da luminária em situações exigentes. Com uma estrutura multi-cell e módulos óticos individuais, Bento é a opção ideal para ambientes onde o conforto e a integração devem ser máximos.

Sistema óptico diseñado  
con microreflectores de  
alta definición que ocultan  
la fuente luminosa

Sistema ótico projetado com  
microrrefletores de alta definição  
que ocultam a fonte luminosa







Downlights  
**Bento**

236

94 mm



Downlights  
**Bento Adjustable**

244

106 mm



Downlights  
**Bento Surface**

335

84 mm



Downlights  
**Bento IP65**

246

117 mm



173 mm



186 mm



163 mm



197 mm



332 mm



491 mm



100 mm



7.8 - 15.4W



Spot 15° - Ultra Flood 50°  
Trim



14-14 60-60 14-60

Trimless



14-14 14-60

7.8 - 15.4W



Spot 15° - Ultra Flood 50°  
Trim



14-14 60-60 14-60

7.8 - 15.4W



Spot 15° - Ultra Flood 50°  
Trim



14-60 60-60

7.8 - 15.4W

Trim / Trimless



14-60



Downlights  
**Bento IP66 Surface**

Downlights  
**Bento Wallwasher**

Low Voltage  
**Bento Low Voltage**

Low Voltage  
**Bento Low Voltage  
Wallwasher**

338

248

124

124

75 mm



189 mm

143 mm

99 mm

142 mm



194 mm

274 mm



278 mm



14.7W



Spot 15° - Flood 47°

○ ● ○ ● ○ ● ○ ● ○ ● ○ ●  
14 60 34 DL E3 J6 Z5

7.8 - 15.4W



Spot 15° - Ultra Flood 50°

○ ●  
14 60

7.8 - 15.4W



Spot 15° - Ultra Flood 50°

60-14 60-60

7.8 - 15.4W



Wall Washer

○ ●  
14 60



## Microreflectores de alta definición

## Microrrefletores de alta definição

El sistema óptico de Bento es el resultado de un minucioso proyecto de desarrollo. Los microrreflectores de alta definición, integrados en el innovador difusor antideslumbramiento negro o blanco, consiguen un  $UGR < 10$  y ocultan la fuente luminosa, garantizando así un excelente confort visual.

O sistema óptico de Bento é o resultado de um meticuloso projeto de desenvolvimento. Os microrrefletores de alta definição integrados no inovador difusor antiencadeamento preto ou branco conseguem um  $UGR < 10$  e ocultam a fonte luminosa, garantindo assim um excelente conforto visual.



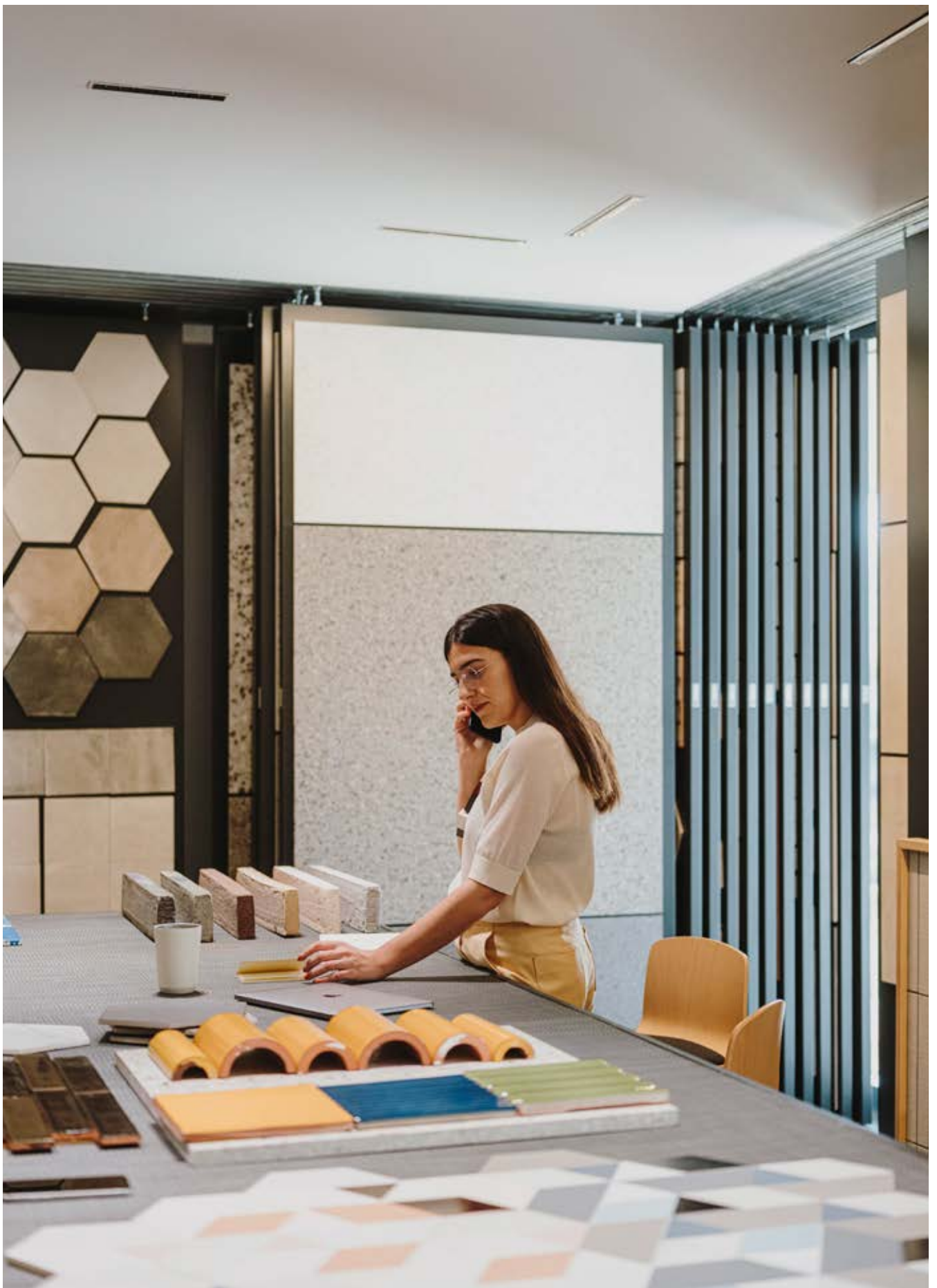

UGR<16 y excelente confort visual  
UGR <16 e excelente conforto visual





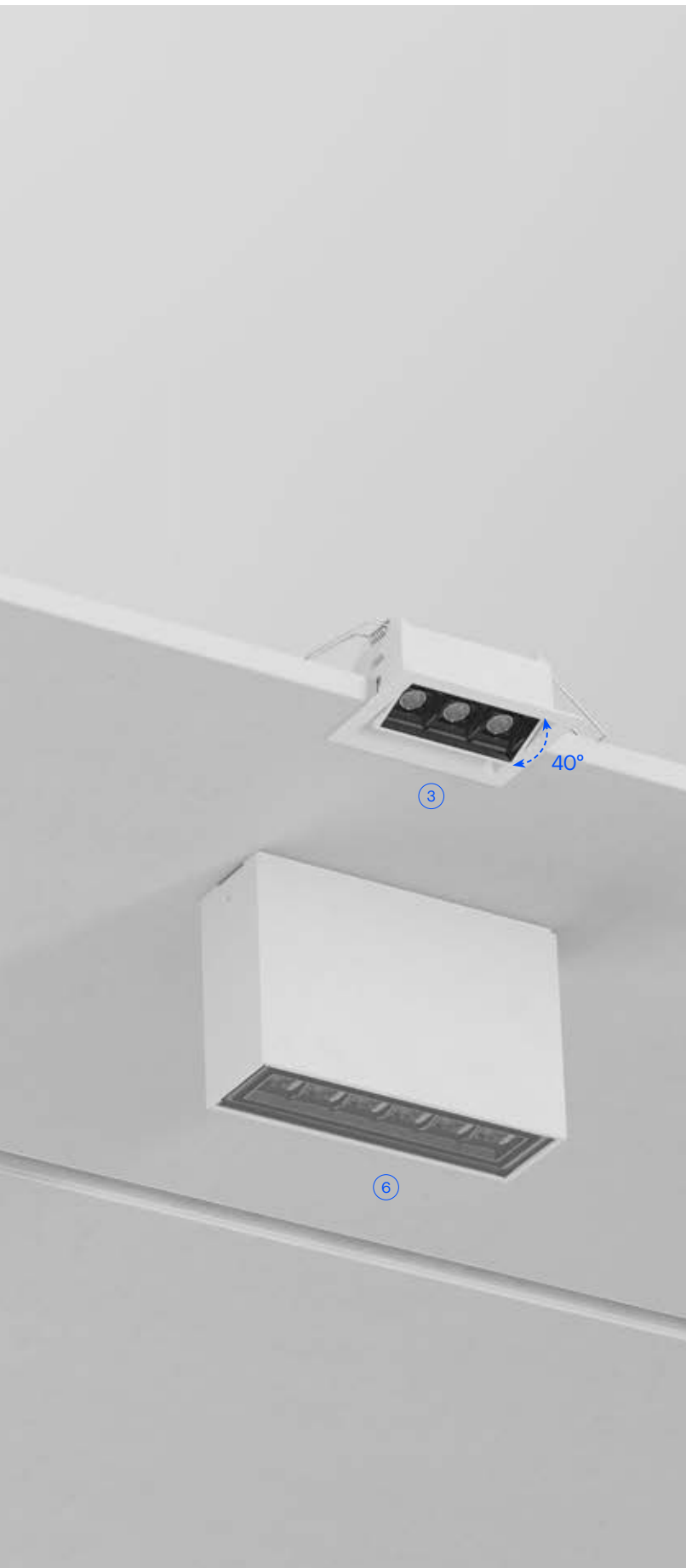

- ① Recessed Trim
- ② Wallwasher Trim
- ③ Adjustable
- ④ Surface
- ⑤ IP65 Recessed
- ⑥ IP66 Surface
- ⑦ Low Voltage
- ⑧ Low Voltage Wallwasher



Proyecto Iberspa. Lleida. Fotografía: Jordi Anguera.  
Projeto Iberspa. Lleida. Fotografía: Jordi Anguera.

Versión utilizada: Bento Standard  
Objetivo del proyecto: efecto dark light en cabina para un elevado confort visual y mínimo deslumbramiento.  
Versão utilizada Bento Standard  
Objetivo do projeto: efeito dark light na cabine para um alto conforto visual e brilho mínimo.



Versión utilizada: Bento Standard y Bento Surface para integración en techo de madera.  
Se ha utilizado un versión Casambi con regulación para aprovechamiento de la luz natural mediante Bluetooth Mesh.

Versão utilizada: Bento Standard e Bento Surface para integração em tetos de madeira.  
Foi utilizada uma versão Casambi com regulação para aproveitamento da luz natural através de Bluetooth Mesh.

# Bento Wall Washer

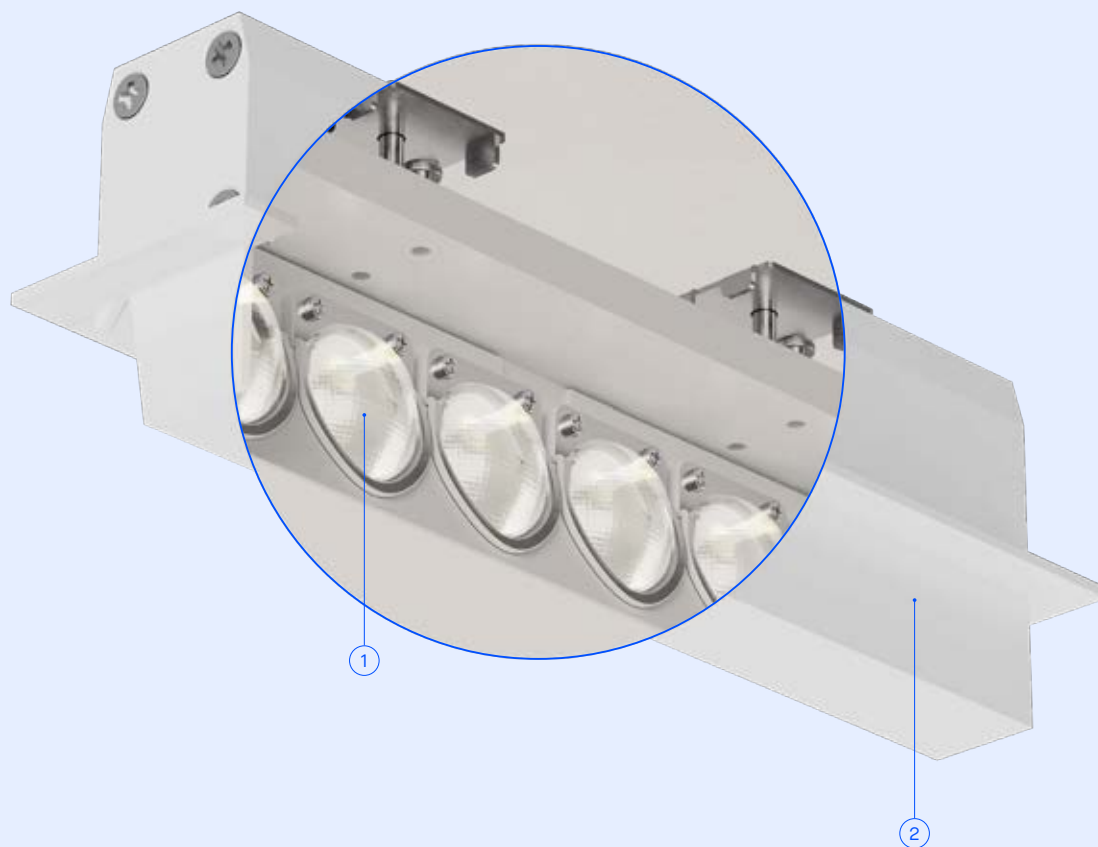

- ① Reflectores micrograbados y en forma de cuchara para bañado de pared homogéneo.  
Refletores microgravados e em forma de colher para um washlight de parede homogéneo.
- ② Pantalla longitudinal para efecto Dark Light.  
Quebra-luz longitudinal para efeito Dark Light.





# Luno Slim

Designed by LedsC4 Architectural



+ Luno Slim



Luno Slim, en su versión superficie y suspendida, se integra en el espacio de forma sutil gracias a un superfil abombado, aportando una luz de calidad que evoca el efecto de un tragaluz.

Luno Slim, na sua versão superfície e suspensa, integra-se no espaço de forma subtil graças ao seu perfil abaulado, fornecendo uma luz de qualidade que evoca o efeito de uma claraboia.



Expresión versátil  
con distintos tamaños  
y acabados

Expressão versátil com  
diferentes tamanhos  
e acabamentos

Ceiling  
**Luno Slim Surface**

**304**

Pendant  
**Luno Slim Pendant**

**284**

Ø 484 mm



Ø 484 mm



Ø 600 mm



Ø 600 mm



Ø 896 mm



Ø 896 mm

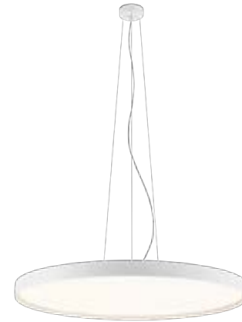

Ø 1190 mm



Ø 1190 mm



27.8 - 108.2W



14 60

27.8 - 108.2W



14 60



Difusor microprismático especialmente  
diseñado para conseguir hasta 121 lm/W  
Difusor microprismático especialmente  
concebido para atingir até 121 lm/W





Posibilidad de instalación  
superficie o suspendida  
Possibilidade de instalação  
na superfície ou suspensa

Tensores de cable especiales  
para dar la rigidez y consistencia  
adecuada a la pieza  
Tensores de cabo especiais  
para dar a rigidez e  
consistência certas à peça

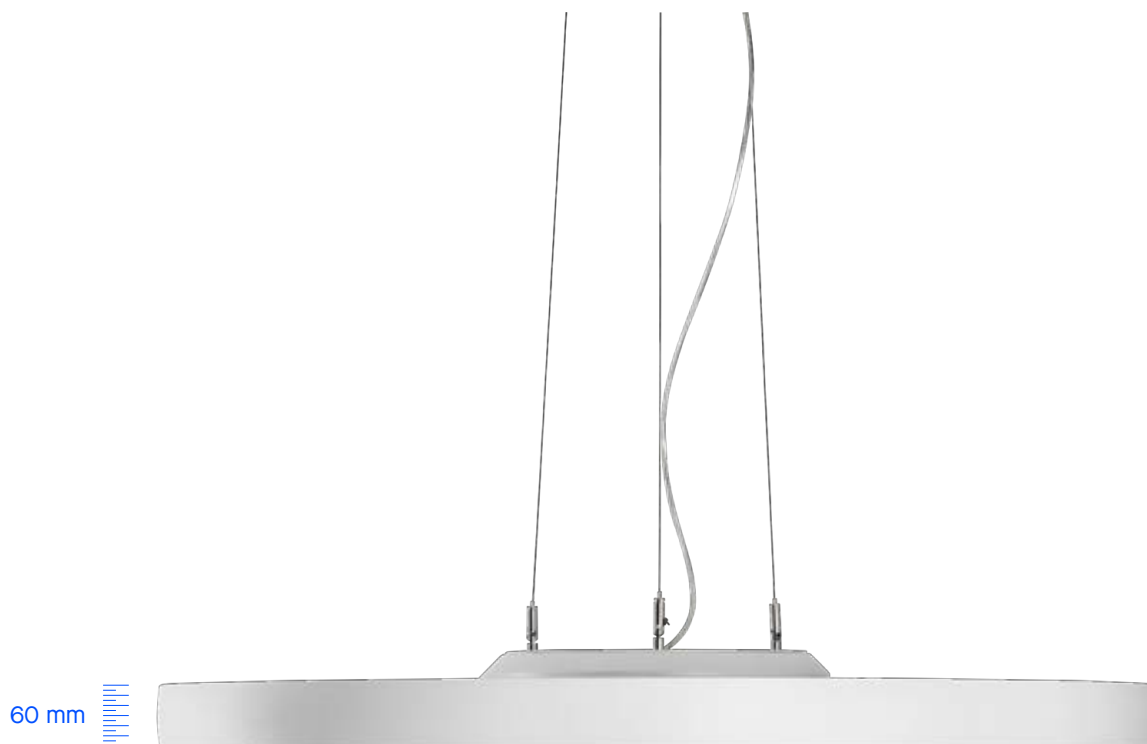

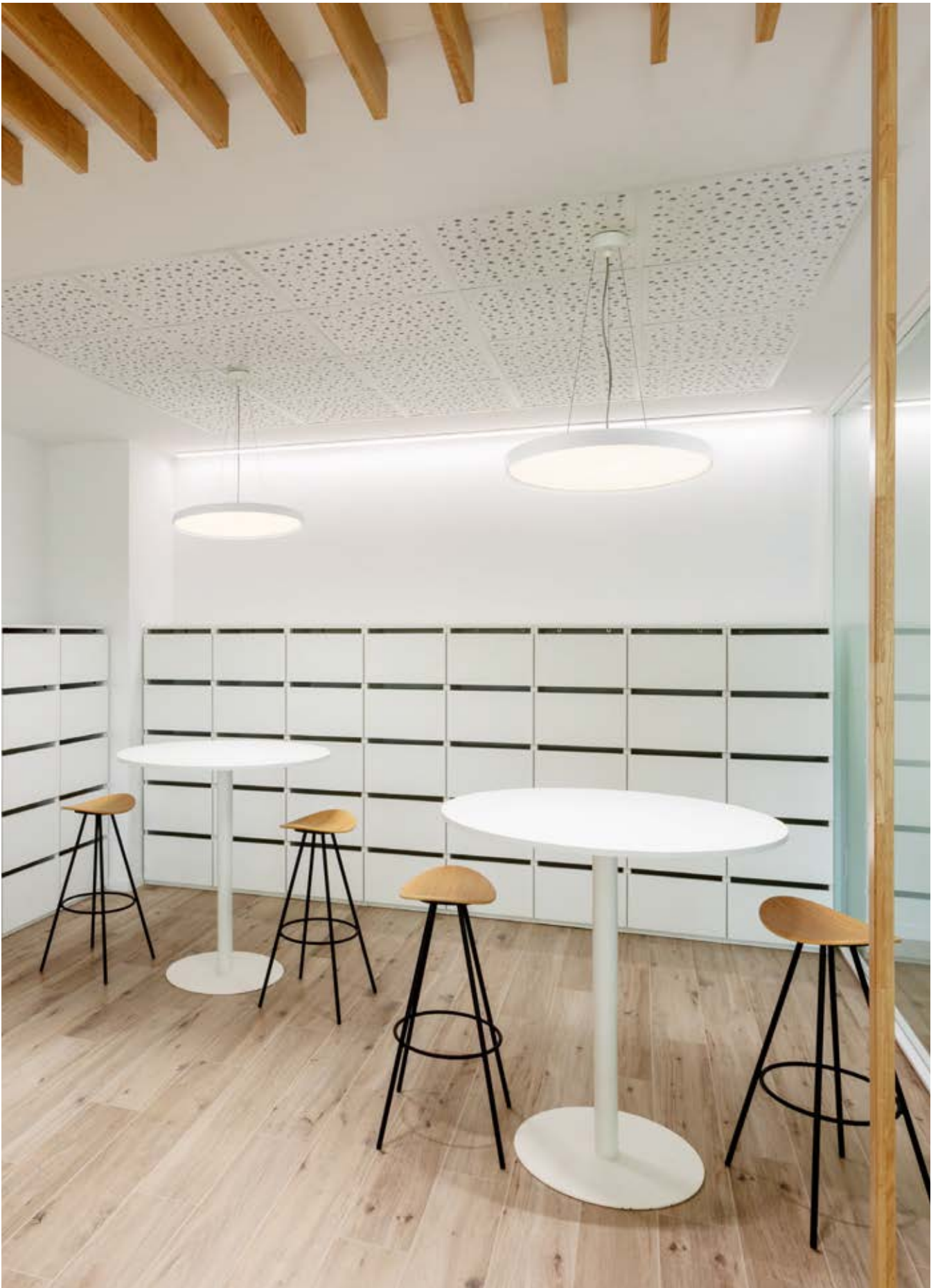



# Multidir Evo

Designed by LedsC4 Architectural



+ Multidir Evo



Colección tipo cardan para instalaciones en superficie y empotrado. Versátiles y dotados de un sistema mecánico de rotación que permite llevar la luz a cualquier punto, se presentan con interior en negro en todas las versiones, para una mayor integración y confort.

Coleção tipo cardã para instalações na superfície e encastrado. Versáteis e equipados com um sistema mecânico de rotação que permite direccionar a luz para qualquer ponto, estão disponíveis com o interior preto em todas as versões, para uma maior integração e conforto.

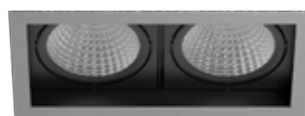

Projectors  
**Multidir Evo Surface**

**314**

Single

120 mm



170 mm



Double

225 mm



322 mm



Downlights  
**Multidir Evo Recessed**

**254**

Single

150 mm



180 mm



Double

200 mm



303 mm



2700 - 4000K  
7.3 - 35.8 W



Spot 18 - Flood 62°



14 60 34

2700 - 4000K  
7.3 - 35.8 W



Spot 18 - Flood 62°

Trim



14 60 34

Trimless



14 60



Flexibilidad de orientación ( $\pm 40$ ) que garantiza la iluminación precisa de cualquier objeto

Flexibilidade de orientação ( $\pm 40$ ) que garante a iluminação precisa de qualquer objeto



## Smart Lighting



La colección Multidir Evo integra la tecnología Casambi Bluetooth Mesh, lo que permite un mayor control de las luminarias y la posibilidad de generar atmósferas luminicas, como una iluminación de acento con control independiente de las luminarias.

A coleção Multidir Evo integra a tecnologia Casambi Bluetooth Mesh, que permite um maior controlo das luminárias e a possibilidade de gerar atmosferas lumínicas, com uma iluminação de realce com controlo independente das luminárias.



Eficiencia 121 Lm/ W CRI90  
Eficiência 121 Lm/ W CRI90



# Kiva

Designed by LedsC4 Architectural



+ Kiva



La colección Kiva viene ampliada con nuevas funcionalidades, pensadas para aportar iluminación a cualquier espacio con facilidad gracias a su rotación 180°. Con posibilidad de montaje empotrado, superficie, en carril o versiones bajo voltaje la colección se amplía con una gran versatilidad y funcionalidad.

A coleção Kiva foi ampliada com novas funcionalidades, pensadas para proporcionar iluminação a qualquer espaço com facilidade. Com a possibilidade de montagem encastrada, superfície, em calha ou versões de baixa tensão, a coleção foi ampliada com uma grande versatilidade e funcionalidade.

Funcionalidad y estética  
en una misma solución  
Funcionalidade e estética  
numa única solução



Projectors  
**Kiva Surface**

**340**

Projectors  
**Kiva Recessed**

**276**

Low Voltage  
**Kiva Low Voltage**

**118**

INDOOR

INDOOR COLLECTIONS

Ø 75 mm



Ø 95 mm



7.8 - 13.2W



Spot 19° - Medium 23°



14 60 81 DN

8.8 - 14W



Spot 19° - Medium 23°

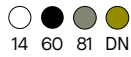

14 60 81 DN

6.4 - 12W



Spot 19° - Medium 23°

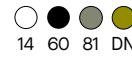

14 60 81 DN



# Rotación longitudinal y giratoria Rotação longitudinal e giratória





# Proyectores / Carriles

## Projetores / Calhas

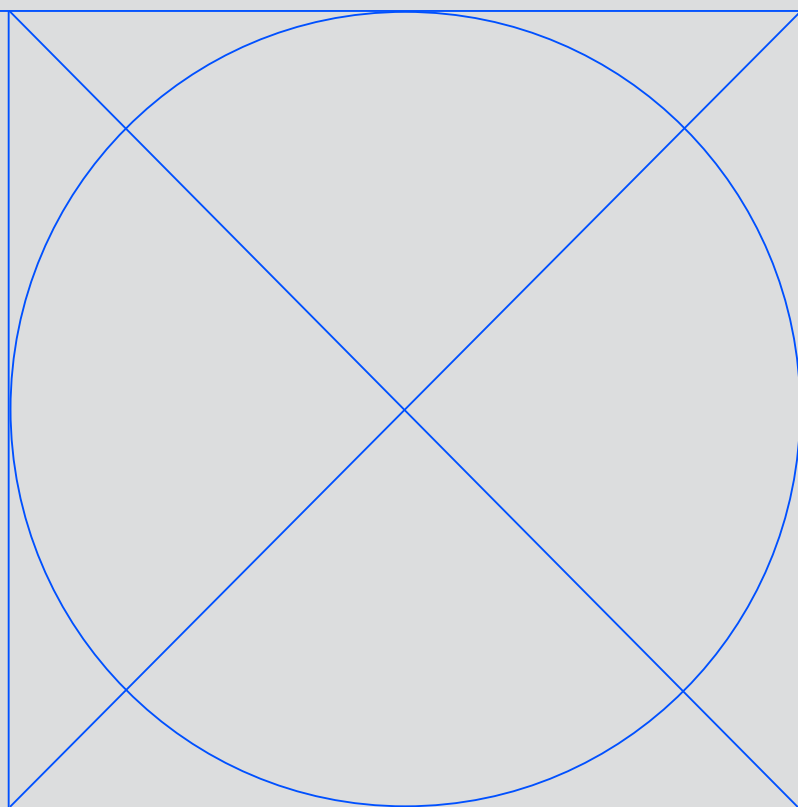

Atom Track

078

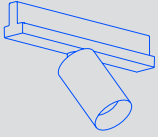

Iris Track

088

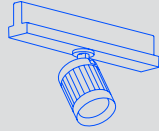

Iris Track Pendant

088

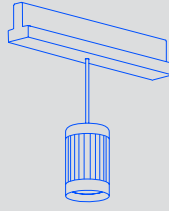

Tak

092

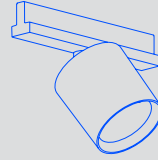

Strom

094

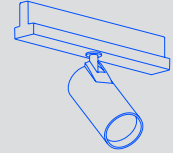

Track Standard

098

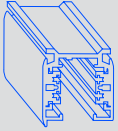

Play

109

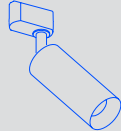

# Atom Track

Designed by LedsC4 Architectural



+ Atom



## Colección versátil para espacios ambivalentes Coleção versátil para espaços ambivalentes

La sencillez es siempre un acierto. La opción de proyector en carril trifásico de Atom es una elección recurrente de los diseñadores en la creación de espacios ambivalentes que requieren de una luz de calidad con gran versatilidad gracias a la gran cantidad de ópticas, instalación y accesorios que presenta la colección.

A simplicidade é sempre uma coisa boa. A opção de projetor em calha trifásica de Atom é uma escolha recorrente dos designers na criação de espaços ambivalentes que requerem luz de qualidade com grande versatilidade graças ao grande número de óticas, instalação e acessórios disponíveis na coleção.





**Atom Track 52** en proyecto de restauración del grupo Tragaluz, Fiskebar. Fotografía: Salva López.  
**Atom Track 52** no projecto de restauração do grupo Tragaluz, Fiskebar. Fotografia: Salva López.



Opciones con CRI98 que garantizan una perfecta reproducción cromática  
Opções com CRI98 que garantem uma reprodução perfeita das cores



**Atom Track 75** en proyecto Casa Tabú de Milan. Excelente reproducción cromática para destacar los colores del producto expuesto. Fotografía: Germano Borrelli.

**Atom Track 75** no projecto Casa Tabú em Milão. Excelente reprodução cromática para realçar as cores do produto em exposição. Fotografía: Germano Borrelli.

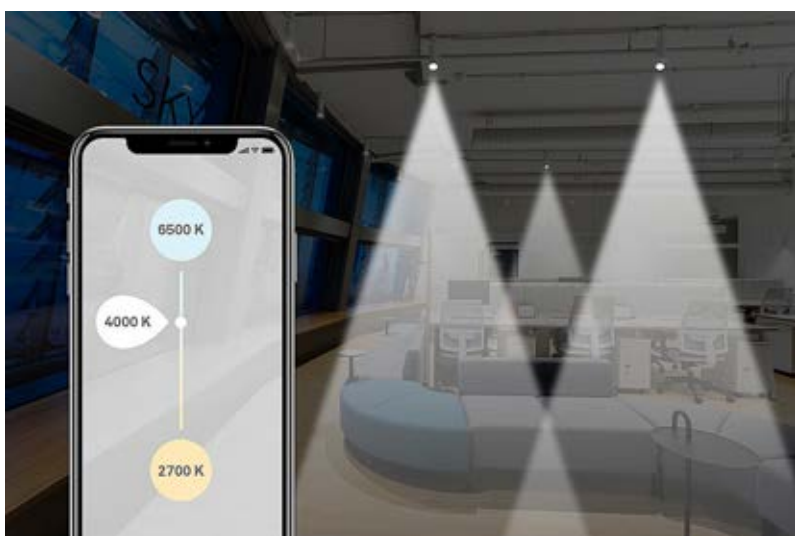

Versiones Tunable White que permiten ajustar la temperatura de color  
Versões Tunable White que permitem ajustar a temperatura da cor

## Zoom manual

## Zoom manual

Sistema que permite controlar el ángulo de apertura del haz de luz pasando de 16° a 47° de forma rápida y cómoda

Sistema que permite controlar o ângulo de abertura do feixe de luz de 16° a 47° de forma rápida e cómoda.

INDOOR

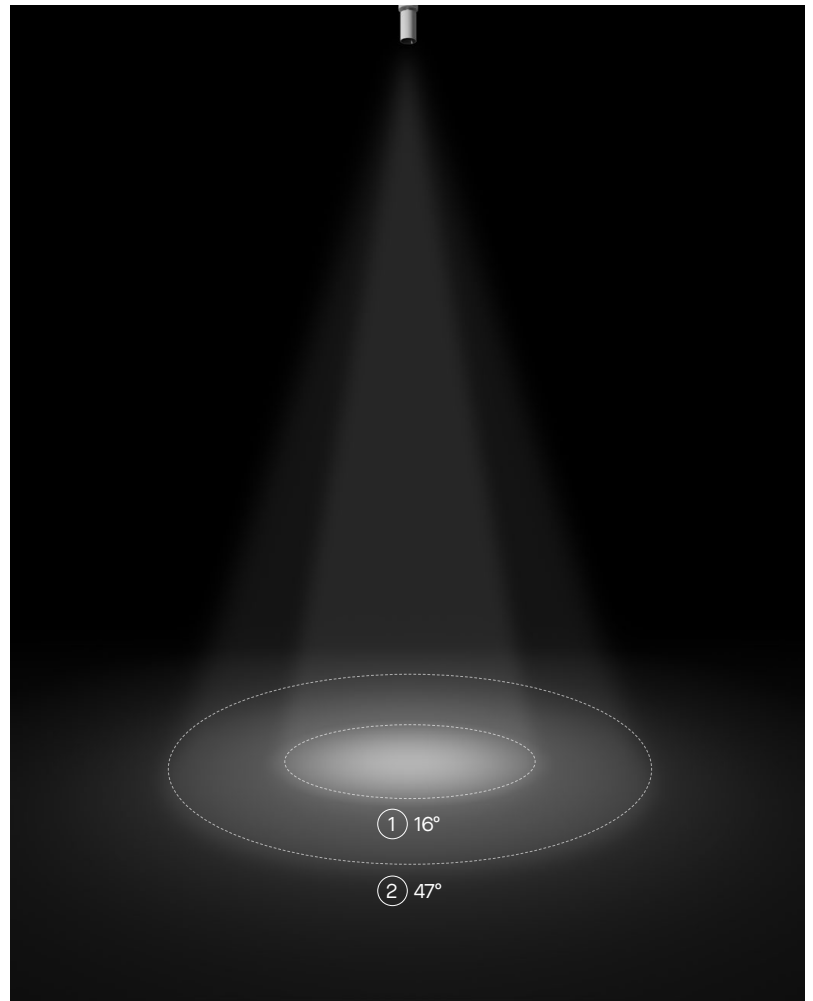

PROYECTORES / CARILLES | PROJETORES / CALHAS

# Atom Track

BODY MAT	50000h	3
AL	L80 B20	MacAdam

## Atom Track 52 LED AC

IP	DIF MAT		WELL					120V
20	PC			320°	90°			

○ ●  
14 60

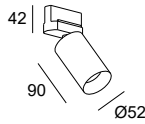

LED						
K	CRI	W Total	Real Lm	Optics	Code	
3000	90	7.5	361	24°	<b>35-6276</b>	- 14 - ML PHASE CUT 120v
3000	90	7.5	304	32°	<b>35-6277</b>	
3000	90	7.5	259	42°	<b>35-6278</b>	

## Atom Track 75 LED AC

IP	DIF MAT		WELL					120V
20	PC			320°	90°			

○ ●  
14 60

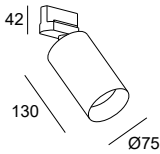

LED						
K	CRI	W Total	Real Lm	Optics	Code	
3000	90	14.3	1005	22°	<b>35-6282</b>	- 14 - ML PHASE CUT 120v
3000	90	14.3	861	31°	<b>35-6283</b>	
3000	90	14.3	668	38°	<b>35-6284</b>	

## Atom Track 97 LED AC

IP	DIF MAT		WELL					120V
20	PC			90°	320°			

○ ●  
14 60

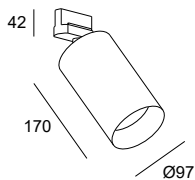

LED						
K	CRI	W Total	Real Lm	Optics	Code	
3000	90	31	1850	24°	<b>35-6288</b>	- 14 - ML PHASE CUT 120v
3000	90	31	1586	36°	<b>35-6289</b>	
3000	90	31	1252	43°	<b>35-6290</b>	

### Atom Track 52 LED Driver

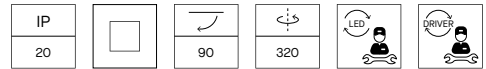

14 60

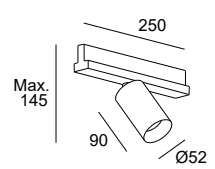

LED									
K	CRI	W Total	Real Lm	Optics	Code				
2700	90	15	1106	20°	<b>35-7287</b>	- 14	<b>OS</b>	ON-OFF 220-240V	
2700	90	15	1230	34°	<b>35-7288</b>	- 60	<b>ES</b>	DALI 220-240V	
2700	90	15	1234	45°	<b>35-7289</b>		<b>XB</b>	CASAMBI 220-240V	
2700	90	10.5	428	8°	<b>35-A021</b>	- 14	<b>OS</b>	ON-OFF 220-240V	
						- 60	<b>ES</b>	DALI-2 220-240V	
3000	90	15	1106	20°	<b>35-7290</b>	- 14	<b>OS</b>	ON-OFF 220-240V	
3000	90	15	1230	34°	<b>35-7291</b>	- 60	<b>ES</b>	DALI 220-240V	
3000	90	15	1234	45°	<b>35-7292</b>		<b>XB</b>	CASAMBI 220-240V	
3000	90	10.5	437	8°	<b>35-A022</b>	- 14	<b>OS</b>	ON-OFF 220-240V	
						- 60	<b>ES</b>	DALI-2 220-240V	
4000	90	15	1271	20°	<b>35-A003</b>	- 14	<b>OS</b>	ON-OFF 220-240V	
4000	90	15	1414	34°	<b>35-A004</b>	- 60	<b>ES</b>	DALI-2 220-240V	
4000	90	15	1418	45°	<b>35-A005</b>		<b>XB</b>	CASAMBI 220-240V	
4000	90	10.5	459	8°	<b>35-A023</b>	- 14	<b>OS</b>	ON-OFF 220-240V	
						- 60	<b>ES</b>	DALI-2 220-240V	
TW 2700-6500	90	14	926	23°	<b>35-A066</b>	- 14			
TW 2700-6500	90	14	1089	38°	<b>35-A067</b>	- 60	<b>- TW</b>	DALI DT8 220-240V	
TW 2700-6500	90	14	1076	49°	<b>35-A068</b>				

### Atom Track 52 LED Driver Zoom

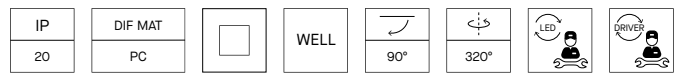

14 60

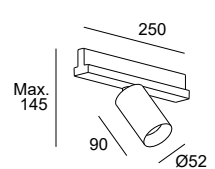

LED									
K	CRI	W Total	Real Lm	Optics	Code				
2700	90	15	518	Zoom 16°-47°	<b>35-A060</b>	- 14	<b>OS</b>	ON-OFF 220-240V	
						- 60	<b>ES</b>	DALI-2 220-240V	
							<b>XB</b>	CASAMBI 220-240V	
3000	90	15	551	Zoom 16°-47°	<b>35-A061</b>	- 14	<b>OS</b>	ON-OFF 220-240V	
						- 60	<b>ES</b>	DALI-2 220-240V	
							<b>XB</b>	CASAMBI 220-240V	
4000	90	15	577	Zoom 16°-47°	<b>35-A062</b>	- 14	<b>OS</b>	ON-OFF 220-240V	
						- 60	<b>ES</b>	DALI-2 220-240V	
							<b>XB</b>	CASAMBI 220-240V	

### Atom Track 75 LED Driver

IP	DIF MAT					
20	PMMA			320	90	LED DRIVER

○ ●  
14 60

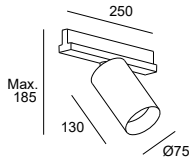

LED									
K	CRI	W Total	Real Lm	Optics	Code				
2700	90	28	2367	23°	<b>35-7305</b>	- 14	<b>OS</b>	ON-OFF	220-240V
2700	90	28	2291	31°	<b>35-7306</b>	- 60	<b>ES</b>	DALI-2	220-240V
2700	90	28	2355	39°	<b>35-7307</b>		<b>XB</b>	CASAMBI	220-240V
3000	90	28	2367	23°	<b>35-7308</b>	- 14	<b>OS</b>	ON-OFF	220-240V
3000	90	28	2291	31°	<b>35-7309</b>	- 60	<b>ES</b>	DALI-2	220-240V
3000	90	28	2355	39°	<b>35-7310</b>		<b>XB</b>	CASAMBI	220-240V
4000	90	28	2722	23°	<b>35-A009</b>	- 14	<b>OS</b>	ON-OFF	220-240V
4000	90	28	2635	31°	<b>35-A010</b>	- 60	<b>ES</b>	DALI-2	220-240V
4000	90	28	2708	39°	<b>35-A011</b>		<b>XB</b>	CASAMBI	220-240V
TW 2700-6500	92	23.8	2214	21°	<b>35-A051</b>	- 14			
TW 2700-6500	92	23.8	2090	34°	<b>35-A052</b>	- 60	<b>TW</b>	DALI DT8	220-240V
TW 2700-6500	92	23.8	2078	46°	<b>35-A053</b>				

### Atom Track 75 LED Driver Zoom

IP		WELL				
20				90°	320°	LED DRIVER

○ ●  
14 60

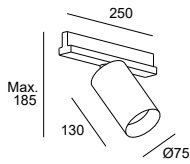

LED									
K	CRI	W Total	Real Lm	Optics	Code				
2700	90	16	1634	Zoom 16°-47°	<b>35-A018</b>	- 14	<b>OS</b>	ON-OFF	220-240V
						- 60	<b>ES</b>	DALI-2	220-240V
3000	90	16	1667	Zoom 16°-47°	<b>35-A019</b>	- 14	<b>OS</b>	ON-OFF	220-240V
						- 60	<b>ES</b>	DALI-2	220-240V
4000	90	16	1751	Zoom 16°-47°	<b>35-A020</b>	- 14	<b>OS</b>	ON-OFF	220-240V
						- 60	<b>ES</b>	DALI-2	220-240V

# Atom Track 97 LED Driver

IP	DIF MAT					
20	PMMA		90	320		

14 60

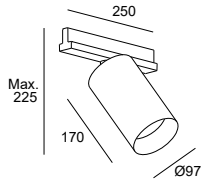

LED										
K	CRI	W Total	Real Lm	Optics	Code					
2700	90	42	3529	20°	<b>35-7323</b>	- 14 - 60	OS	ON-OFF	220-240V	
2700	90	42	3056	31°	<b>35-7324</b>			- ES	DALI-2	220-240V
2700	90	42	2369	42°	<b>35-7325</b>			- XB	CASAMBI	220-240V
3000	90	42	3529	20°	<b>35-7326</b>	- 14 - 60	OS	ON-OFF	220-240V	
3000	90	42	3056	31°	<b>35-7327</b>			- ES	DALI-2	220-240V
3000	90	42	2369	42°	<b>35-7328</b>			- XB	CASAMBI	220-240V
4000	90	42	4059	20°	<b>35-A015</b>	- 14 - 60	OS	ON-OFF	220-240V	
4000	90	42	3514	31°	<b>35-A016</b>			- ES	DALI-2	220-240V
4000	90	42	2724	43°	<b>35-A017</b>			- XB	CASAMBI	220-240V
TW 2700-6500	92	37	3118	22°	<b>35-A077</b>	- 14 - 60	TW	DALI DT8	220-240V	
TW 2700-6500	92	37	2892	32°	<b>35-A078</b>			- TW		
TW 2700-6500	92	37	2212	40°	<b>35-A079</b>					



Atom Track 52 LED  
ACAtom Track 75 LED  
ACAtom Track 97 LED  
AC**Controladores**  
Controladores

P. 1166



DALI

14 ○

-

-

-

60 ●

-

-

-

**Sensores**  
Sensores

P. 1166

Multisensor a carril trifasico  
Multissensor para calha trifásica

60 ●

-

-

-

**Accesorios ópticos**  
Acessórios ópticosDifusor elíptico (5u.)  
Difusor elíptico (5u.)

71-6274-00-00

71-6280-00-00

71-6286-00-00

Difuminador de halo (5u.)  
Difusor opalino (5u.)

71-6275-00-00

71-6281-00-00

71-6287-00-00

Conforto visual (1u.)  
Conforto visual (1u.)

14 ○

-

-

-

60 ●

71-6276-60-00

71-6282-60-00

71-6288-60-00

Panel de abeja (5u.)  
Painel de abelha (5u.)

60 ●

71-6273-60-00

71-6279-60-00

71-6285-60-00

Visera  
Viseira

60 ●

71-6277-60-00

71-6283-60-00

71-6289-60-00

Aletas antideslumbrantes  
Abas antideslumbramento

14 ○

-

-

-

60 ●

-

-

71-6290-60-00

Aro frontal  
Aro frontal

14 ○

71-6436-14-00

71-6437-14-00

71-6438-14-00

23 ●

71-6436-23-00

71-6437-23-00

71-6438-23-00

Atom Track 52 LED Driver	Atom Track 52 LED Driver Zoom	Atom Track 75 LED Driver	Atom Track 75 LED Driver Zoom	Atom Track 97 LED Driver

**Controladores** P. 1166  
**Controladores**

	DALI	14 ○	<b>71-A243-14-14</b>	-	<b>71-A243-14-14</b>	-	<b>71-A243-14-14</b>
		60 ●	<b>71-A243-60-60</b>	-	<b>71-A243-60-60</b>	-	<b>71-A243-60-60</b>

**Sensores** P. 1166  
**Sensores**

	Multisensor a carril trifasico Multissensor para calha trifásica	60 ●	<b>35-A075-60-00</b>	-	<b>35-A075-60-00</b>	-	<b>35-A075-60-00</b>
--	---------------------------------------------------------------------	------	----------------------	---	----------------------	---	----------------------

**Accesorios ópticos**  
**Acessórios óticos**

	Difusor elíptico (5u.) Difusor elíptico (5u.)		<b>71-6274-00-00</b>	-	<b>71-6280-00-00</b>	<b>71-6280-00-00</b>	<b>71-6286-00-00</b>
	Difuminador de halo (5u.) Difusor opalino (5u.)		<b>71-6275-00-00</b>	-	<b>71-6281-00-00</b>	<b>71-6281-00-00</b>	<b>71-6287-00-00</b>
	Confort visual (1u.) Conforto visual (1u.)	14 ○	<b>71-6276-14-00</b>	-	<b>71-6282-14-00</b>	<b>71-6282-14-00</b>	<b>71-6288-14-00</b>
		60 ●	<b>71-6276-60-00</b>	-	<b>71-6282-60-00</b>	<b>71-6282-60-00</b>	<b>71-6288-60-00</b>
	Panel de abeja (5u.) Painel de abelha (5u.)	60 ●	<b>71-6273-60-00</b>	-	<b>71-6279-60-00</b>	<b>71-6279-60-00</b>	<b>71-6285-60-00</b>
	Visera Viseira	60 ●	<b>71-6277-60-00</b>	-	<b>71-6283-60-00</b>	<b>71-6283-60-00</b>	<b>71-6289-60-00</b>
	Aletas antideslumbrantes Abas antideslumbramento	14 ○	-	-	-	-	<b>71-6290-14-00</b>
		60 ●	-	-	-	-	<b>71-6290-60-00</b>
	Aro frontal Aro frontal	14 ○	<b>71-6436-14-00</b>	-	<b>71-6437-14-00</b>	<b>71-6437-14-00</b>	<b>71-6438-14-00</b>
		23 ●	<b>71-6436-23-00</b>	-	<b>71-6437-23-00</b>	<b>71-6437-23-00</b>	<b>71-6438-23-00</b>

# Iris Track

Designed by Artec3 Studio



+ Iris



## Potencia y control del haz Potência e controlo do feixe

Proyector y colgante para carril trifásico con versatilidad de acabados y combinación de componentes. Con una óptima eficiencia lumínica, la diversidad de ópticas de Iris permite acentuar los objetos iluminados con gran potencia y control del haz.

Projetor para calha trifásica com versatilidade de acabamentos e combinação de componentes. Com ótima eficiência lumínica, a diversidade de óticas da Iris permite acentuar os objetos iluminados com grande potência e controlo do feixe.

Iris Track Spotlight







Iris Track Pendant











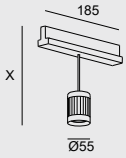







BODY MAT		50000h	2
AL		L80 B20	MacAdam











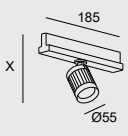

## Iris Colgante Carril

	IP 23			
-------------------------------------------------------------------------------------	----------	-------------------------------------------------------------------------------------	-------------------------------------------------------------------------------------	-------------------------------------------------------------------------------------

Ejemplo de código / Exemplo de código: **AV25-P6V9U10S60**

Model	W	K / Cri / Real lm		Optics	Source	Finishes*		
 <p><b>AV25 -</b> Track Pendant IP23</p> 	<b>P6</b> 6.3W	<b>V9</b> 2700K / CRI90 / 533 lm	<b>U</b> Hoop 	<b>1</b> 15°	<b>OS</b>  ON-OFF 220-240V	<b>60</b>  <b>L7</b>  <b>L8</b>  <b>L9</b>  <b>O1</b>  <b>O2</b>  <b>O7</b>  <b>O8</b> 		
		<b>W9</b> 3000K / CRI90 / 268 lm	<b>V</b> Visual Comfort 				<b>2</b> 35°	<b>DS</b>   DALI-2 220-240V
		<b>X9</b> 4000K / CRI90 / 707 lm	<b>X</b> Cone 					
	<b>12</b> 12.5W	<b>V9</b> 2700K / CRI 90 / 1183 lm	<b>Y</b> Glass 	<b>3</b> 50°				
		<b>W9</b> 3000K / CRI 90 / 555 lm	<b>Z</b> Pipe 					
		<b>X9</b> 4000K / CRI 90 / 1477 lm						
	<b>18</b> 18.1W	<b>V9</b> 2700K / CRI 90 / 1592 lm						
		<b>W9</b> 3000K / CRI 90 / 761 lm						
		<b>X9</b> 4000K / CRI 90 / 2037 lm						

\*Consulta las combinaciones de acabados a través del configurador online [iris-ledsc4.com](http://iris-ledsc4.com)  
\*Consulte as combinações de acabamentos através do configurador online [iris-ledsc4.com](http://iris-ledsc4.com)

Model	W	K / Cri / Real lm	Shade	Optics	Source	Finishes*	
 	<b>P6</b> 6.3W	<b>V9</b> 2700K / CRI 90 / 533 lm	<b>U</b> Hoop 	<b>1</b> 15°	<b>OS</b> ON-OFF 220-240V	<b>60</b>  <b>L7</b>  <b>L8</b>  <b>L9</b>  <b>07</b>  <b>08</b> 	
		<b>W9</b> 3000K / CRI 90 / 268 lm	<b>V</b> Visual Comfort 	<b>2</b> 35°			<b>DS</b> DALI-2 220-240V
		<b>X9</b> 4000K / CRI 90 / 707 lm		<b>3</b> 50°			
	<b>12</b> 12.5W	<b>V9</b> 2700K / CRI 90 / 1183 lm	<b>X</b> Cone 				
		<b>W9</b> 3000K / CRI 90 / 555 lm	<b>Y</b> Glass 				
		<b>X9</b> 4000K / CRI 90 / 1477 lm					
	<b>18</b> 18.1W	<b>V9</b> 2700K / CRI 90 / 1592 lm	<b>Z</b> Pipe 				
		<b>W9</b> 3000K / CRI 90 / 761 lm					
		<b>X9</b> 4000K / CRI 90 / 2037 lm					

### Iris Colgante Carril



### Iris Proyector Carril



### Controladores

P. 1166



DALI

60 ●

71-A243-60-60

71-A243-60-60

### Accesorios ópticos

#### Acessórios óticos



Difusor elíptico (5u.)  
Difusor elíptico (5u.)

71-5167-00-00

71-5167-00-00



Difusor cuadrado (5u.)  
Difusor quadrado (5u.)

71-5658-00-00

71-5658-00-00



Difuminador de halo (5u.)  
Difusor opalino (5u.)

71-6099-00-00

71-6099-00-00



Panel de abeja (5u.)  
Painel de abelha (5u.)

60 ●

71-5166-60-00

71-5166-60-00



Apantallador (5u.)  
Obturador assimetrico (5u.)

60 ●

71-7895-60-00

71-7895-60-00



# Tak

Designed by LedsC4 Architectural



Practicidad, funcionalidad y eficiencia definen este proyector, ideal para aplicaciones de Retail que necesitan un alto confort visual y una perfecta reproducción cromática en una solución compacta. El driver está incluido en la luminaria e integrado en el carril.

Praticidade, funcionalidade e eficiência definem este projetor, ideal para aplicações de Retail que exijam um elevado conforto visual e uma reprodução perfeita das cores numa solução compacta. O driver está incluído na luminária e integrado na calha.

Medida compacta  
Tamanho compacto

Excelente dissipación térmica  
Excelente dissipação técnica



BODY MAT
AL

DIF MAT
PC



50000h
L80 B20

2
MacAdam

IP
20

90°
-----

320°
------

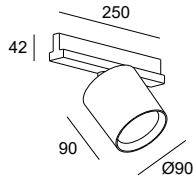

LED									
K	CRI	W Total	Real Lm	Optics	Code				
3000	90	32.8	2893	16°	<b>35-A054</b>	14	OS	ON-OFF	220-240V
3000	90	32.8	2849	27°	<b>35-A055</b>	60	DS	DALI-2	220-240V
3000	90	32.8	2813	55°	<b>35-A056</b>				
4000	90	32.8	2937	16°	<b>35-A057</b>	14	OS	ON-OFF	220-240V
4000	90	32.8	2892	27°	<b>35-A058</b>	60	DS	DALI-2	220-240V
4000	90	32.8	2856	55°	<b>35-A059</b>				

## Controladores

P. 1166



DALI

14 ○

**71-A243-14-14**

60 ●

**71-A243-60-60**

## Accesorios ópticos

Accesórios óticos



Panel de abeja (5u.)  
Painel de abelha (5u.)

60 ●

**71-A177-60-00**



# Strom



El proyector Strom está especialmente diseñado para una iluminación de acento en el ámbito del Retail y Museos. Gracias a una cuidada selección de la fuente luminosa y a su elevada reproducción cromática, Strom realza los colores en los productos expuestos.

O projetor Strom é especialmente concebido para iluminação de realce em ambientes de lojas e museus. Graças à cuidadosa seleção da fonte de luz e à sua elevada reprodução de cores, a Strom realça as cores nos produtos expostos.





## Excelente uniformidad Excelente uniformidade



Eficiencia de 95 lm/w  
Eficiência de 95 lm/w

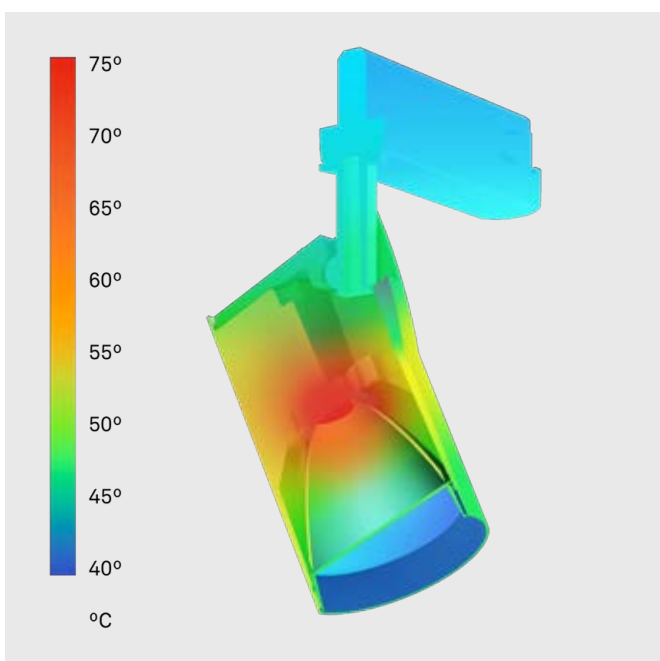

### Alto grado de eficiencia Alto grau de eficiência

Un preciso diseño enfocado en la disipación pasiva, consigue que el gradiente de temperatura se transfiera al medio de forma eficiente.

Un design preciso incentrato sulla dissipazione passiva assicura che il gradiente di temperatura venga trasferito al fluido in modo efficiente.

BODY MAT	DIF MAT		50000h	2
AL	PC		L80 B20	MacAdam

## Strom ø55

NEW	IP 20	90°	355°	LED	DRIVER
-----	----------	-----	------	-----	--------

○ ●  
H2 G7

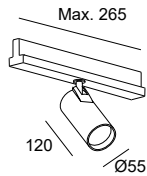

LED									
K	CRI	W Total	Real Lm	Optics	Code				
3000	90	23.6	2272	15	<b>35-A090</b>	- H2	OS	ON-OFF	220-240V
3000	90	23.6	2250	24	<b>35-A091</b>	- G7	- DS	DALI-2	220-240V
3000	90	23.6	2227	38	<b>35-A092</b>		XB	CASAMBI	220-240V
3500	90	23.6	2297	15	<b>35-A093</b>	- H2	OS	ON-OFF	220-240V
3500	90	23.6	2275	24	<b>35-A094</b>	- G7	- DS	DALI-2	220-240V
3500	90	23.6	2252	38	<b>35-A095</b>		XB	CASAMBI	220-240V
4000	90	23.6	2362	15	<b>35-A096</b>	- H2	OS	ON-OFF	220-240V
4000	90	23.6	2339	24	<b>35-A097</b>	- G7	- DS	DALI-2	220-240V
4000	90	23.6	2315	38	<b>35-A098</b>		XB	CASAMBI	220-240V

## Strom ø80

NEW	IP 20	90°	320°	LED	DRIVER
-----	----------	-----	------	-----	--------

○ ●  
H2 G7

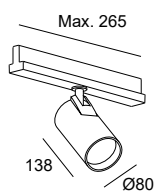

LED									
K	CRI	W Total	Real Lm	Optics	Code				
3000	90	34	3294	15	<b>35-A118</b>	- H2	OS	ON-OFF	220-240V
3000	90	34	3266	24	<b>35-A123</b>	- G7	- DS	DALI-2	220-240V
3000	90	34	3219	38	<b>35-A126</b>		XB	CASAMBI	220-240V
3500	90	34	3627	15	<b>35-A120</b>	- H2	OS	ON-OFF	220-240V
3500	90	34	3534	24	<b>35-A124</b>	- G7	- DS	DALI-2	220-240V
3500	90	34	3542	38	<b>35-A127</b>		XB	CASAMBI	220-240V
4000	90	34	3607	15	<b>35-A122</b>	- H2	OS	ON-OFF	220-240V
4000	90	34	3500	24	<b>35-A125</b>	- G7	- DS	DALI-2	220-240V
4000	90	34	3543	38	<b>35-A128</b>		XB	CASAMBI	220-240V

## Strom ø80 Bread / Fish / Meat

NEW	IP 20	320°	90°	LED	DRIVER
-----	----------	------	-----	-----	--------

○ ●  
H2 G7

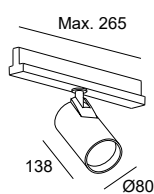

LED									
K	W Total	Real Lm	Optics	Code					
Bread	34	2233	38	<b>35-A131</b>	- H2	- OS	ON-OFF	220-240V	
Fish	34	2371	38	<b>35-A130</b>	- H2	- OS	ON-OFF	220-240V	
Meat	34	1513	38	<b>35-A129</b>	- H2	- OS	ON-OFF	220-240V	



# Track



+ Track



Track es la colección de carriles trifásicos de LedsC4. En sus versiones Standard y Euro Dali se presentan con diversas opciones, todas con gran versatilidad y posibilidades de composición. Track é a coleção de calhas da LedsC4. As suas versões Standard e Euro Dali apresentam-se com diversas opções, todas com grande versatilidade e possibilidades de composição.



Proyecto especial **Atom Track**. Laboratorio lumínico de Vic. Foto: Leafhopper.  
Projecto especial **Atom Track**. Laboratório Vic Light. Foto: Leafhopper.



Proyecto Showroom Tabu. **Atom Track**. Fotos: Germano Borrelli.  
Proyecto Tabu Showroom. **Atom Track**. Fotos: Germano Borrelli.

## Esquema de instalación Track Standard Surface

### Esquema de instalação Track Standard Surface



① Joint



② Straight track connector



③ Flexible Joint



④ L Joint

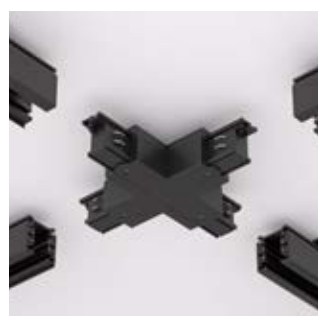

⑤ X Joint

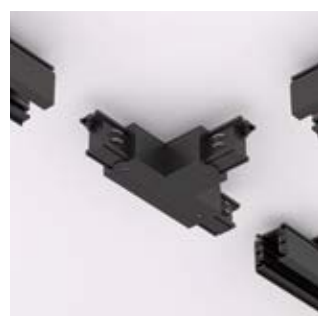

⑥ T Joint

**Surface**

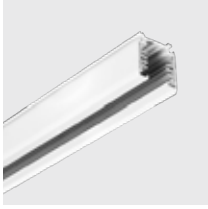

**Pendant**



**Recessed**



Track se presenta en versión Trim y Trimless con opción de superficie, colgante, empotrado en acabados blanco y negro.

Track apresenta-se em versão Trim e Trimless com opção de superfície, encastrado, suspensão e acabamentos branco e preto.

**Track Standard Surface and Pendant**

Las posibilidades de composición con marco o sin marco siguen un esquema de composición por referencias con distintos conectores propuestos.

As possibilidades de composição com aro ou sem aro seguem um esquema de composição por referências com diferentes conectores propostos.

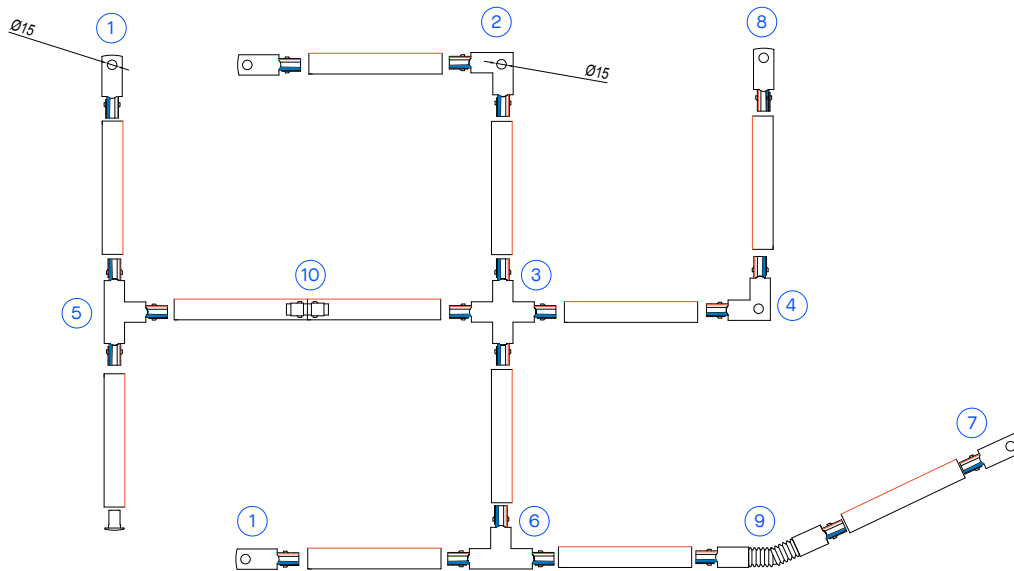

**TRIMLESS**

- ① 71-5214 
- ② 71-5219 
- ③ 71-5231 
- ④ 71-5220 
- ⑤ 71-5227 
- ⑥ 71-5228 
- ⑦ 71-5215 

**TRIM**

- ① 71-5216 
- ② 71-5221 
- ③ 71-5232 
- ④ 71-5222 
- ⑤ 71-5229 
- ⑥ 71-5230 
- ⑦ 71-5217 

**TRIMLESS & TRIM**

- ① 71-5218 
- ⑨ 71-5223 
- ⑩ 71-5224 







### Tracks Standard Trimless Surfaced & Pendant

○ ●  
14 60

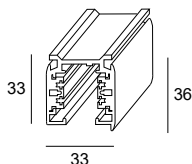

mm	Code
2000	71-5210 - 14 - 00
3000	71-5211 - 60 - 00

### Track Standard Recessed

○ ●  
14 60

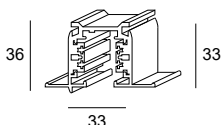

mm	Code
2000	71-5213 - 14 - 00
	71-5213 - 60 - 00

#### Tracks Standard Trimless Surfaced & Pendant





#### Track Standard Recessed











### Accesorios de fijación requeridos Acessórios de fixação requeridos

	Florón suspendido con toma de corriente ON-OFF Florão suspenso com tomada de corrente ON-OFF	14 ○	<b>71-7520-14-00</b>	-
		60 ●	<b>71-7520-60-00</b>	-
	Sirga acero + clip montaje suspendido (2u.) Cabo de aço + clipe montagem suspenso (2u.)	14 ○	<b>71-7656-14-00</b>	-
		60 ●	<b>71-7656-60-00</b>	-
	Clip fijación directa en techos (4u.) Clipe fixação direta no teto (4u.)	14 ○	<b>71-5225-14-00</b>	<b>71-5225-14-00</b>
		60 ●	<b>71-5225-60-00</b>	<b>71-5225-60-00</b>
	Kit para empotrar (2u.) Kit para encastrar (2u.)	-	-	<b>ACT-9165-48-00</b>

### Accesorios de unión Acessórios de união

	Conector "I" ON-OFF Conetor "I" ON-OFF	14 ○	<b>71-B219-14-00</b>	<b>71-B219-14-00</b>
		60 ●	<b>71-B219-60-00</b>	<b>71-B219-60-00</b>
	Tapa final (1u.) Tampa final (1u.)	14 ○	<b>71-5218-14-00</b>	<b>71-5218-14-00</b>
		60 ●	<b>71-5218-60-00</b>	<b>71-5218-60-00</b>

**Accesorios de conexión**  
**Acessórios de conexão**

	Conector derecho "L" Conetor direito "L"	14 ○	<b>71-5220-14-00</b>	<b>71-5222-14-00</b>
		60 ●	<b>71-5220-60-00</b>	<b>71-5222-60-00</b>
	Conector izquierdo "L" Conetor esquerdo "L"	14 ○	<b>71-5219-14-00</b>	<b>71-5221-14-00</b>
		60 ●	<b>71-5219-60-00</b>	<b>71-5221-60-00</b>
	Conector derecho "T" Conetor direito "T"	14 ○	<b>71-5228-14-00</b>	<b>71-5230-14-00</b>
		60 ●	<b>71-5228-60-00</b>	<b>71-5230-60-00</b>
	Conector izquierdo "T" Conetor esquerdo "T"	14 ○	<b>71-5227-14-00</b>	<b>71-5229-14-00</b>
		60 ●	<b>71-5227-60-00</b>	<b>71-5229-60-00</b>
	Conector derecho Conetor direito	14 ○	<b>71-5215-14-00</b>	<b>71-5217-14-00</b>
		60 ●	<b>71-5215-60-00</b>	<b>71-5217-60-00</b>
	Conector izquierdo Conetor esquerdo	14 ○	<b>71-5214-14-00</b>	<b>71-5216-14-00</b>
		60 ●	<b>71-5214-60-00</b>	<b>71-5216-60-00</b>
	Conector "X" Conetor "X"	14 ○	<b>71-5231-14-00</b>	<b>71-5232-14-00</b>
		60 ●	<b>71-5231-60-00</b>	<b>71-5232-60-00</b>
	Conector flexible Conetor flexível	14 ○	<b>71-5223-14-00</b>	<b>71-5223-14-00</b>
		60 ●	<b>71-5223-60-00</b>	<b>71-5223-60-00</b>
	Conector continuidad Conetor continuidade	14 ○	<b>71-5224-14-00</b>	<b>71-5224-14-00</b>
		60 ●	<b>71-5224-60-00</b>	<b>71-5224-60-00</b>

BODY MAT
AL

### Surface

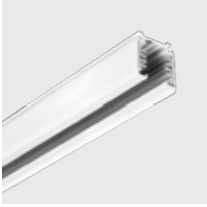

### Pendant



En versión adosada y suspensión y acabados blanco y negro, Track Euro Dali es la opción conectiva del carril con diferentes opciones de conectividad.

Na versão saliente e de suspensão e acabamentos branco e preto, Track Euro Dali é a opção conectiva da calha com diferentes opções de conectividade.

### Track Euro Dali Surface and Pendant

Las posibilidades de composición sin marco siguen un esquema de composición por referencias con distintos conectores propuestos.

As possibilidades de composição sem aro seguem um esquema de composição por referências com diferentes conectores propostos.

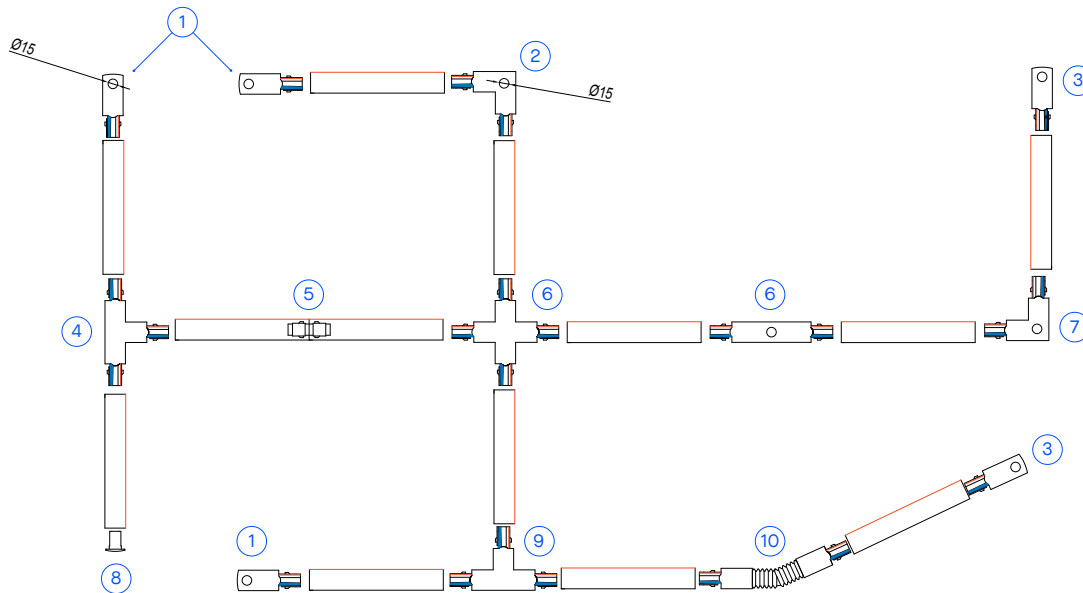

### TRIMLESS

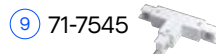
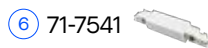
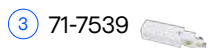
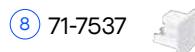
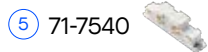
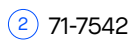
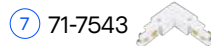
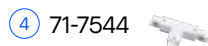
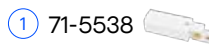

**Tracks Euro Dali Trimless  
Surfaced & Pendant**



INDOOR

○ ●  
14 60

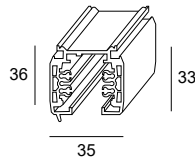

mm	Code
1000	<b>71-7534</b>
2000	<b>71-7535</b> - 14 - 00
3000	<b>71-7536</b> - 60 - 00

**Controladores**  
Controladores

P. 1166



DALI

14 ○ **71-A243-14-14**

60 ● **71-A243-60-60**

**Accesorios de fijación requeridos**  
Acessórios de fixação requeridos



Florón suspendido con toma de corriente DALI  
Florão suspenso com tomada de corrente DALI

14 ○ **71-7521-14-00**

60 ● **71-7521-60-00**



Sirga acero + clip montaje suspendido (2u.)  
Cabo de aço + clipe montagem suspenso (2u.)

14 ○ **71-7656-14-00**

60 ● **71-7656-60-00**

**Accesorios de unión**  
Acessórios de união



Tapa final (1u.)  
Tampa final (1u.)

14 ○ **71-7537-14-00**

60 ● **71-7537-60-00**

**Accesorios de conexión**  
Acessórios de conexão



Conector derecho "L" DALI  
Conetor direito "L" DALI

14 ○ **71-7543-14-00**

60 ● **71-7543-60-00**



Conector izquierdo "L" DALI  
Conetor esquerdo "L" DALI

14 ○ **71-7542-14-00**

60 ● **71-7542-60-00**



Conector derecho "T" DALI  
Conetor direito "T" DALI

14 ○ **71-7545-14-00**

60 ● **71-7545-60-00**



Conector izquierdo "T" DALI  
Conetor esquerdo "T" DALI

14 ○ **71-7544-14-00**

60 ● **71-7544-60-00**



Conector derecho DALI  
Conetor direito DALI

14 ○ **71-7539-14-00**

60 ● **71-7539-60-00**



Conector izquierdo DALI  
Conetor esquerdo DALI

14 ○ **71-7538-14-00**

60 ● **71-7538-60-00**



Conector "I" DALI  
Conetor "I" DALI

14 ○ **71-7541-14-00**

60 ● **71-7541-60-00**



Conector "X" DALI  
Conetor "X" DALI

14 ○ **71-7546-14-00**

60 ● **71-7546-60-00**



Conector flexible DALI  
Conetor flexível DALI

14 ○ **71-7547-14-00**

60 ● **71-7547-60-00**



Mini conector "I" DALI  
Mini conetor "I" DALI

14 ○ **71-7540-14-00**

60 ● **71-7540-60-00**

## Play Deco Track

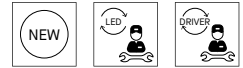

Ejemplo de código / Exemplo de código: **AG71-P7V9S20UWG**

Model	W	K / Cri / Real lm	Optics	Source	Finishes
  <p>Max. 290 ∅73</p>	<b>P7</b> 8.6W	<b>V9</b> 2700K / CRI 90 / 549 lm (M2)	<b>S2</b> 14°	<b>OU</b> ON-OFF 100-240V	<b>WG</b> <b>WH</b> <b>WL</b> <b>WM</b> <b>WN</b> <b>WR</b>
		<b>W9</b> 3000K / CRI 90 / 637 lm (M2)	<b>M2</b> 28°	<b>DU</b> DALI-2 110-277V	
		<b>X9</b> 4000K / CRI 90 / 637 lm (M2)	<b>F1</b> 49°	<b>TS</b> PHASE CUT 220-240V	
	<b>13</b> 14.4W	<b>V9</b> 2700K / CRI 90 / 1159 lm (M2)	<b>S2</b> 19°		
		<b>W9</b> 3000K / CRI 90 / 1248 lm (M2)	<b>M2</b> 34°		
		<b>X9</b> 4000K / CRI 90 / 1335 lm (M2)	<b>F1</b> 45°		

### Drivers Driver

P. 1166



**71-A260-00-00**



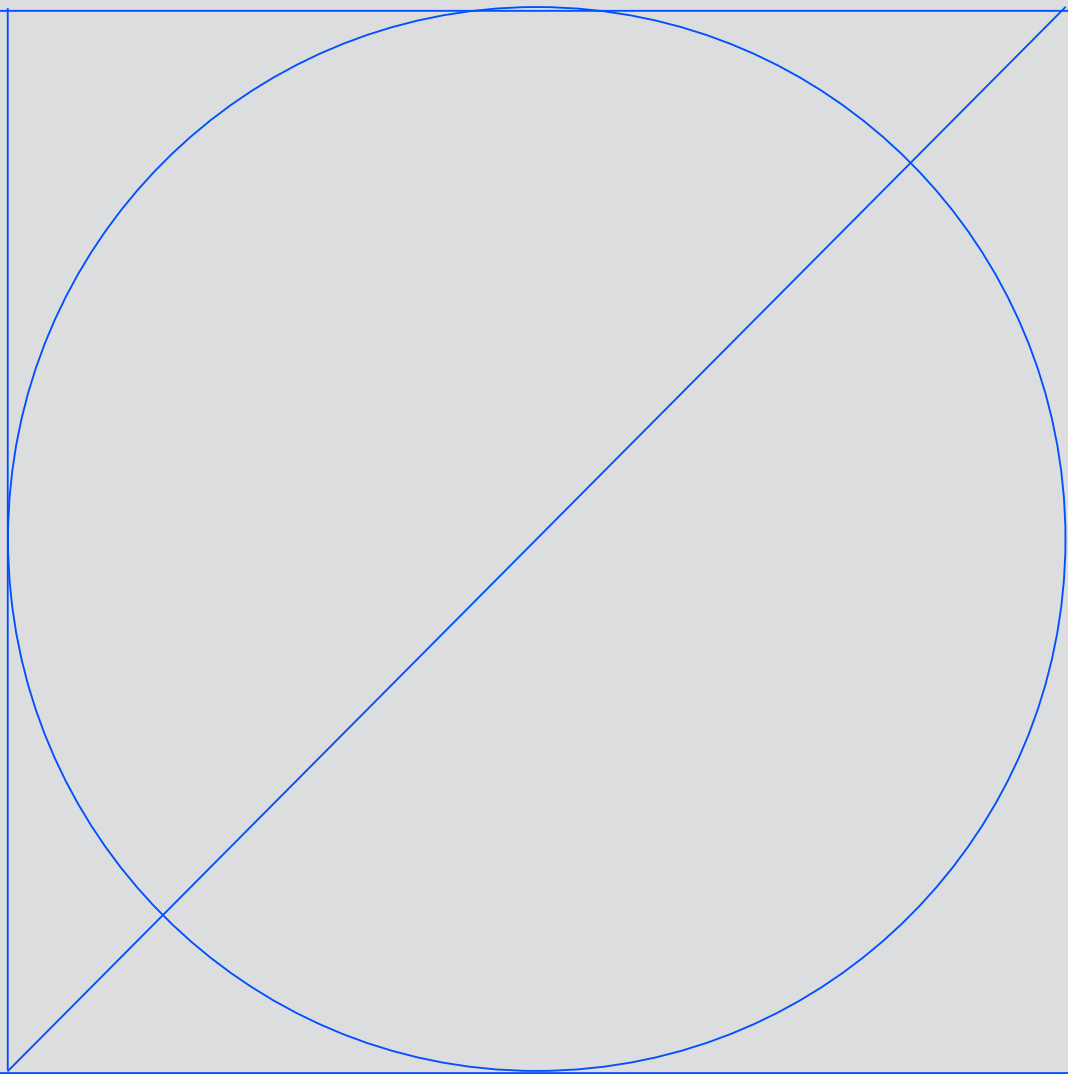

LV

# Bajo Voltaje Baixa Tensão

Atom LV

116

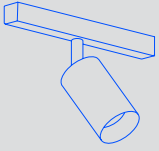

Kiva LV

118

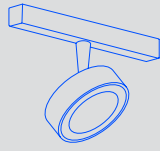

Iris LV

120

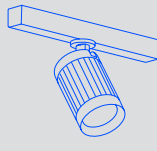

Strom LV

142

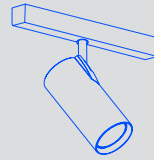

Tango LV

122

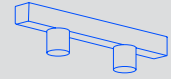

Bento LV

124

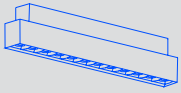

Nara LV

126

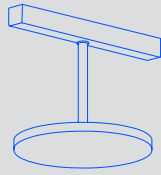

On LV

128

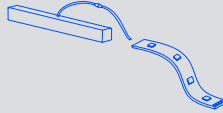

Infinite LV

130



Vela LV

146



Track LV

132

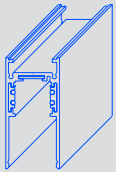

Low Voltage  
**Atom**

**116**

Ø 30 mm



Low Voltage  
**Kiva**

**118**

Ø 75 mm



Low Voltage  
**Iris**

**120**

Ø 55 mm



Spotlight

Low Voltage  
**Strom**

**142**

Ø 55 mm



Low Voltage  
**Tango**

**122**

22 mm



Low Voltage  
**Bento**

**124**

99 mm



Standard

Ø 52 mm



Ø 95 mm



Ø 55 mm



Downlight

22 mm



194 mm



Ø 55 mm

Pendant



142 mm

Wall Washer



274 mm

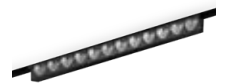

3.1 - 12.1 W



Ultra Spot 8°  
Ultra Flood 43°

○ ● ● ● ● ●  
14 60 81 DN

6.4 - 12 W



Ultra Medium 24°

○ ● ● ● ● ●  
14 60 81 DN

6 - 18 W



Extra Spot 15°  
Ultra Flood 50°

● ● ● ● ● ● ● ● ● ● ● ●  
60 L7 L8 L9 05 06

24 W



Spot 15°  
Ultra Medium 38°

○ ●  
H2 G7

1.4- 2.8 W



Medium 23°

○  
14

6 - 12 W



Ultra Medium 25°  
Wall Washer

○ ●  
14 60



Low Voltage  
**Infinite**  
**130**

Low Voltage  
**On**  
**128**

Low Voltage  
**Nara**  
**126**

Low Voltage  
**Vela**  
**146**

Low Voltage  
**Track**  
**132**

462 mm

500mm

Ø 157 mm

Ø 30 mm

Surface



950 mm

1000mm

Pendant



464 mm

2000mm

Recessed

High output



950 mm

3000mm

Up&Down



6.5 - 13 W

3.9 - 19.2 W

13.4 W

3.1 W



Flood 92°



Ultra Medium 24°



60



14



14 60



60



14 60



# Low Voltage



Sistema polivalente basado en la combinación de un perfil magnético, alimentado a 48V, y distintas soluciones lumínicas como proyectores, colgantes y lineales. Puede instalarse de manera vertical u horizontal y dispone de versiones de instalación empotrada, en superficie y suspendida. El sistema Low Voltage ofrece al diseñador una gran libertad, pudiendo iluminar espacios cambiantes y versátiles, ajustando y moviendo los puntos de luz para adaptarlos a las exigencias de cada momento.

Sistema polivalente baseado na combinação de um perfil magnético, alimentado a 48V, e diferentes soluções lumínicas como projetores, suspensos e lineares. Pode ser instalado vertical ou horizontalmente e possui versões de instalação encastrada, salientes e suspensas. O sistema Low Voltage oferece ao designer uma grande liberdade, podendo iluminar espaços mutáveis e versáteis, ajustando e movendo os pontos de luz para adaptá-los às exigências de cada momento.





# Atom

Dos medidas y acabados Essence  
Dois tamanhos e acabamentos Essence

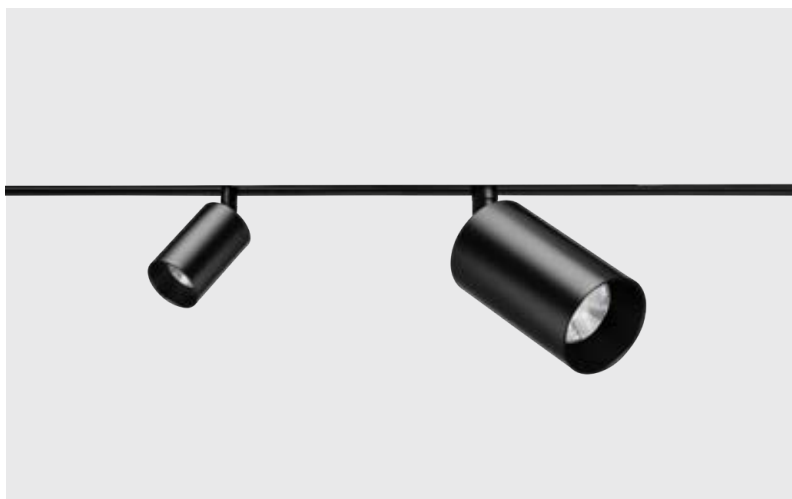

Ø 30 / Ø 50mm

14

60

81

DN

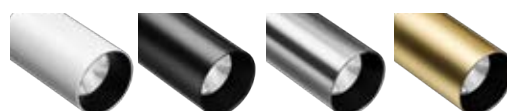

## Zoom manual Zoom manual

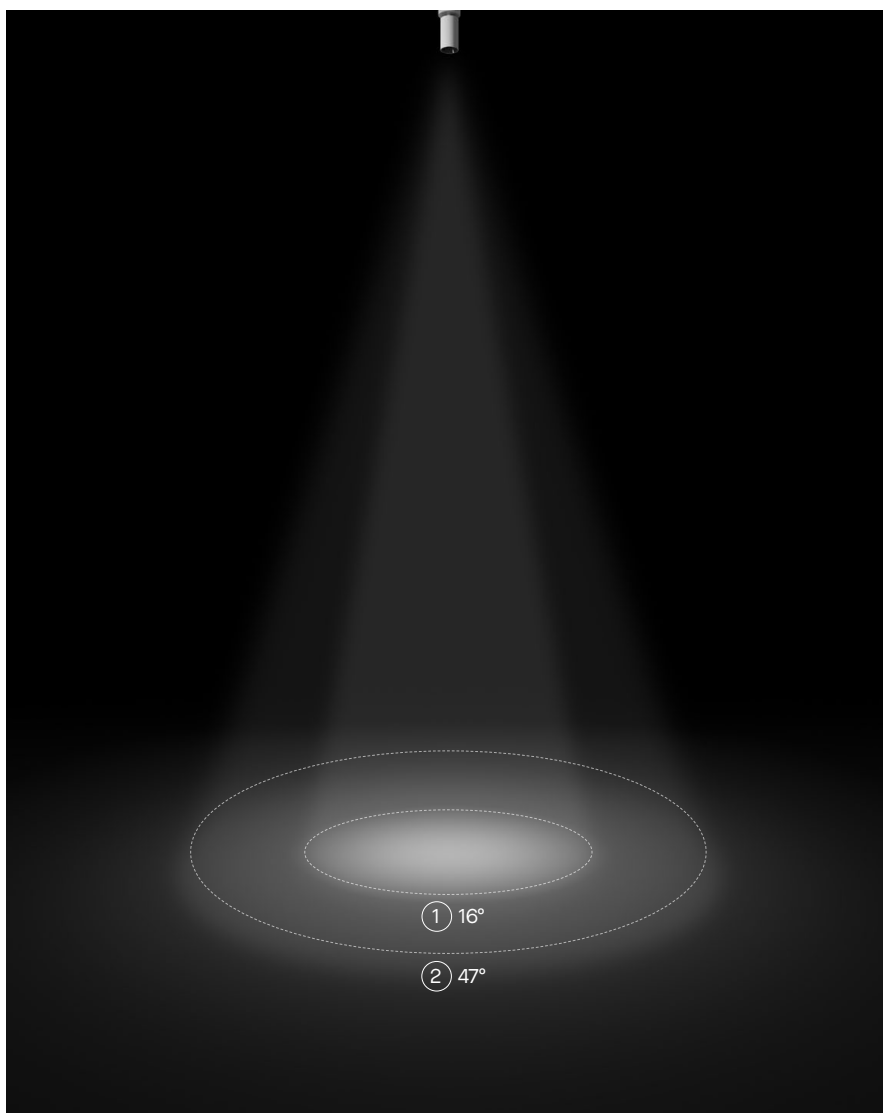



**Atom Low Voltage**, ideal para iluminar expositores.  
**Atom Low Voltage**, ideal para iluminação de displays.

# Kiva

Disponibile en 4 acabados que se adaptan al ambiente con una versatilidad necesaria en entornos retail o de exposición

Disponível em 4 acabamentos que se adaptam ao ambiente com uma versatilidade necessária em ambientes retail ou de exposição



Disponibile en acabado blanco, negro, satin níquel y oro.  
Disponível nos acabamentos branco, preto, níquel acetinado e dourado.

## Rotación longitudinal y giratoria Rotação longitudinal e giratória





**Kiva Low Voltage** en sala de reuniones de la fundación ONCE. Iluminación controlada con un alto grado de eficiencia. Fotografía: Álvaro Valdecantos.

**Kiva Low Voltage** na sala de reuniões da fundação ONCE. Iluminação controlada com um elevado grau de eficiência. Fotografía: Álvaro Valdecantos.



# Iris

Modularidad de  
componentes  
y acabados

Modularidade de  
componentes e  
acabamentos

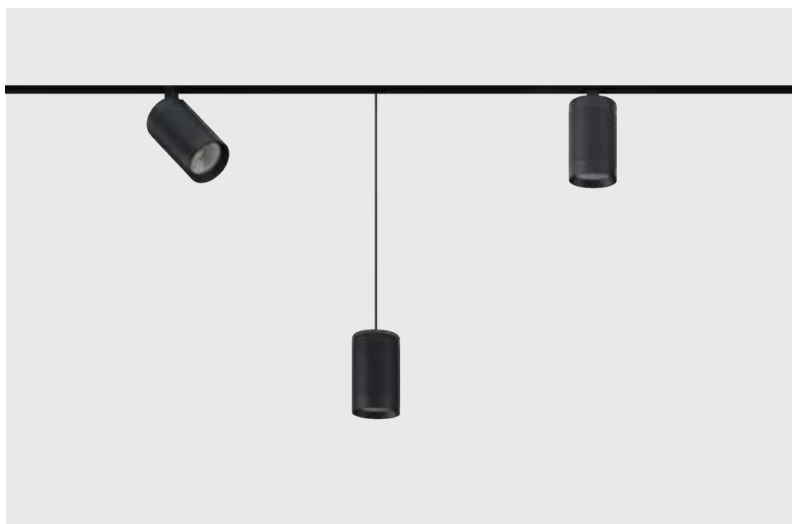

Iris Low Voltage, en versiones de hasta 18W se presenta con aplicaciones proyector, colgante y downlight.

Iris Low Voltage, em versões de até 18W, apresenta-se com aplicações projetor, suspenso e downlight.



\* Todos los acabados tienen combinación con vidrio transparente.

\* Todos os acabamentos têm combinação com vidro transparente.



**Iris Low Voltage** colgante es una opción ideal para espacios como restaurantes que buscan una solución técnica, con confort y control, a la vez que decorativa.  
Pendente **Iris Baixa Tensão** é uma opção ideal para espaços como restaurantes que procuram uma solução técnica, com conforto e controle, bem como decorativos.



# Tango

Los proyectores, dobles o individuales, se ocultan discretos y con un tamaño muy compacto en el carril, iluminando ambientes pasando prácticamente desapercibidos

Os projetores, duplos ou individuais, discretamente ocultos e com um tamanho muito compacto na calha, iluminam os ambientes passando praticamente despercebidos



Tango es una solución ideal para ambientes de restauración y retail.  
Tango é a solução ideal para ambientes de restauração e retail.





## Bento

Dos opciones, standard y Wall Washer, para adaptarse a diferentes necesidades lumínicas  
Duas opções, standard e Wall Washer para caber diferentes necessidades de iluminação



Bento Low Voltage Wall Washer.

Reflectores micrograbados en forma de cuchara para un bañado de pared homogéneo  
Refletores microgravados em forma de colher para lavagem de parede homogênea





**Bento Standard** en carril Low Voltage para un proyecto de residencia privada en Barcelona.

**Bento Standard** em calha Low Voltage para um projeto de residência privada em Barcelona.

## Nara

Solución técnica y decorativa con muchas posibilidades

Solução técnica e decorativa com muitas possibilidades



Los accesorios de fieltro en acabados gris oscuro y gris claro confieren un plus estético a la colección muy valorado en entornos retail y contract.

Os acessórios de feltro com acabamento cinzento-escuro e cinzento-claro dão um plus estético à coleção que é altamente valorizada em ambientes de retail e contract.







**Nara** se incorpora como novidade en las soluciones Low Voltage.  
**Nara** incorpora-se como novidade nas soluções Low Voltage.



# On

Tira LED para perfil Track Low Voltage Up & Down, ideal para iluminar techos dando un plus de amplitud a los espacios

Fita LED para Faixa de perfil baixo Voltagem para cima e para baixo, ideal para iluminar tectos e dar de amplitude para os espaços



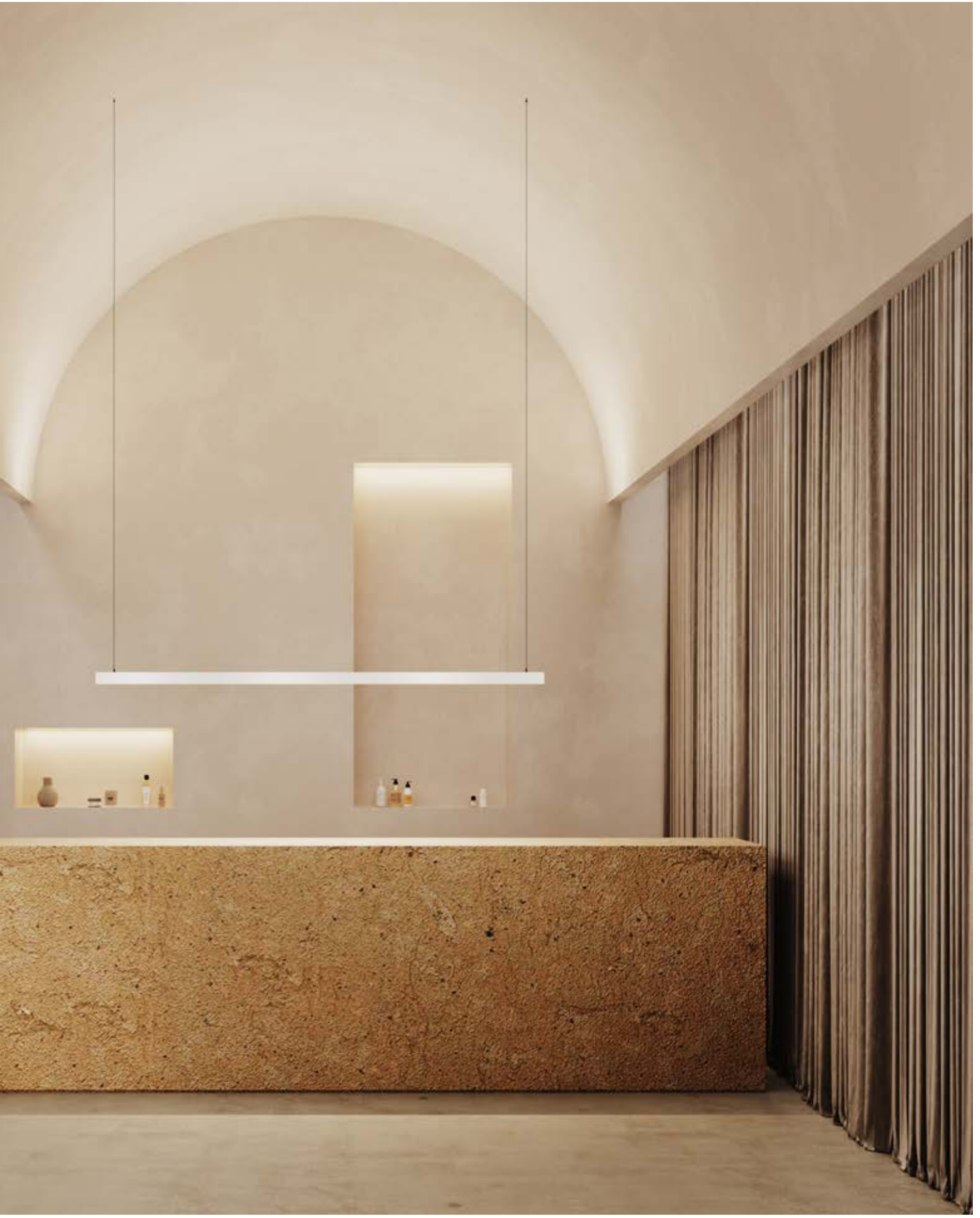

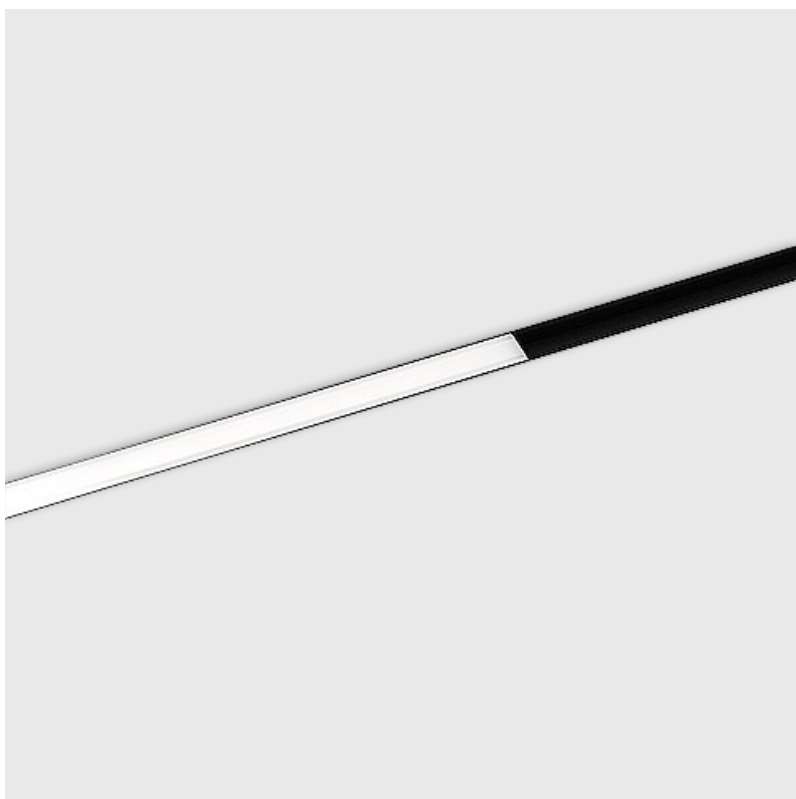

## Infinite

Iluminación lineal y homogénea integrada en el carril de bajo voltaje

Iluminação linear e homogénea integrada em calha de baixa tensão

---

Como novidade se incorpora el modelo High Output con doble paquete lumínico  
Como novidade, é incorporado o modelo High Output, com duplo pacote lumínico





# Track

Perfil compacto disponible en distintas aplicaciones empotrada, de superficie, suspendida y Up & Down

Perfil compacto disponível em diferentes aplicações, encastrada, de superfície, suspenso e Up & Down

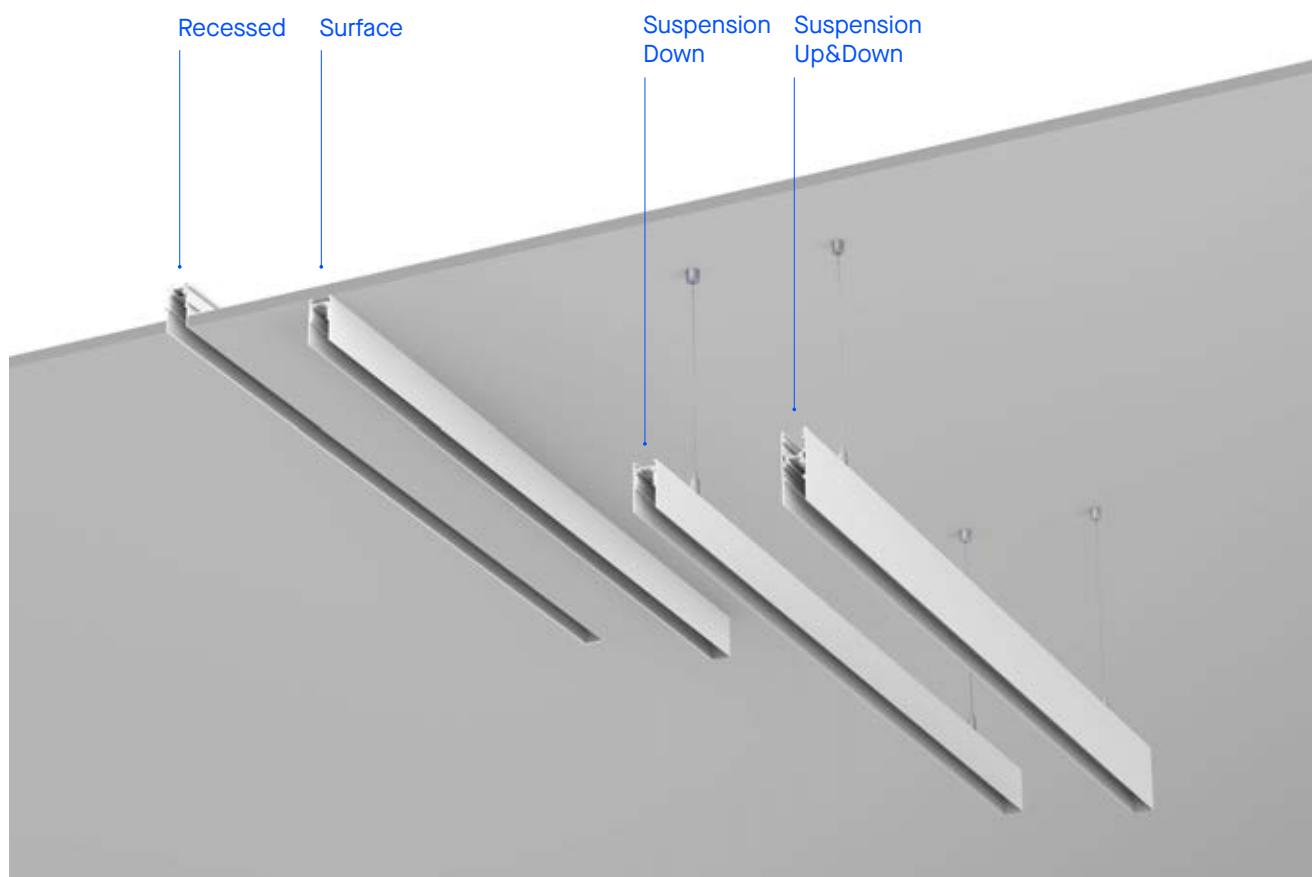

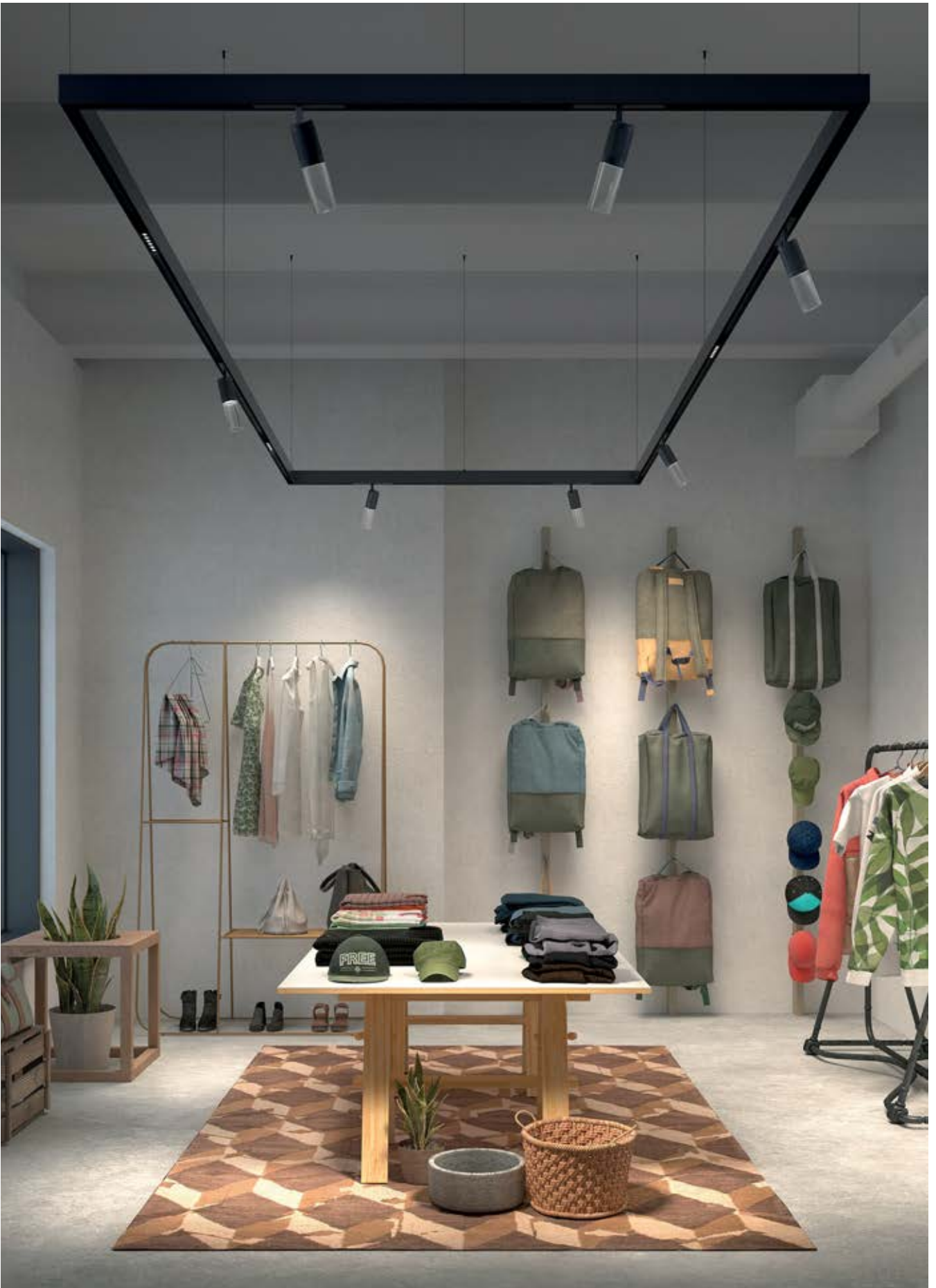

Iris y Bento Low Voltage en Track Low Voltage Pendant.  
Iris e Bento Low Voltage en Track Low Voltage Pendant.



# Esquema de instalación Track Low Voltage Surface

## Esquema de instalação Track Low Voltage Surface



① Power source, end cap and power connector



② I Joint



③ T Joint



④ X Joint



⑤ L Joint



⑥ I Joint



⑦ L Joint

## Funcionalidad Smart Funcionalidade Smart

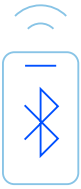

## Atmósferas lumínicas Atmosferas lumínicas

La tecnología Smart aplicada a Low Voltage permite un control de las luminarias para adaptarse a las necesidades del proyecto. En el caso de conexión mediante Bluetooth Mesh, pueden programarse de forma individual para generar atmósferas más precisas en ambientes que así lo exigen.

A tecnologia Smart aplicada a Low Voltage permite o controlo das luminárias para se adaptar às necessidades do projeto. No caso de ligação mediante Bluetooth Mesh, podem ser programadas de forma individual para gerar atmosferas mais precisas em ambientes que o exijam.

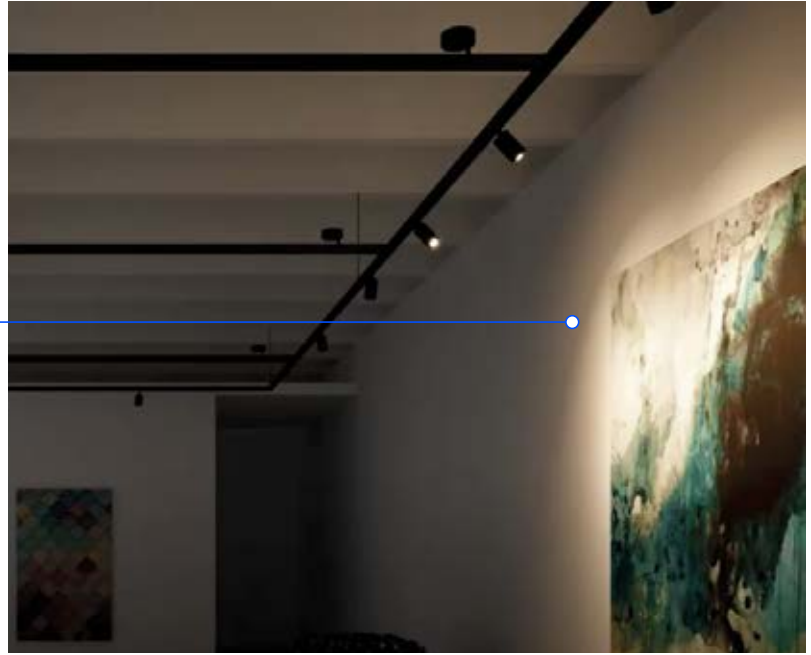

## Atom Low Voltage 30

IP	WELL				
20		360°	90°		

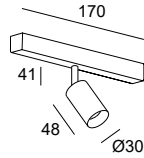
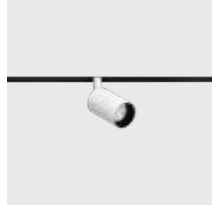

○ ●  
14 60

LED											48VDC
K	CRI	W Total	Real Lm	Optics	Code						
2700	90	3.1	269	37°	<b>35-7285</b>	- 14	OO	ON-OFF	48 VDC		
						- 60	- DA	DALI	48 VDC		
							XB	CASAMBI	48 VDC		
3000	90	3.1	269	37°	<b>35-7286</b>	- 14	OO	ON-OFF	48 VDC		
						- 60	- DA	DALI	48 VDC		
							XB	CASAMBI	48 VDC		

## Atom Low Voltage 52

IP	WELL				
20		360°	90°		

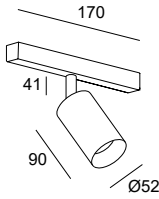

○ ● ● ●  
14 60 81 DN

LED											48VDC
K	CRI	W Total	Real Lm	Optics	Code						
2700	90	12.1	853	24°	<b>35-7279</b>	14	OO	ON-OFF	48 VDC		
2700	90	12.1	928	32°	<b>35-7280</b>	- 60	- DA	DALI	48 VDC		
2700	90	12.1	778	44°	<b>35-7281</b>	- 81	XB	CASAMBI	48 VDC		
2700	90	8.2	428	8°	<b>35-A072</b>	DN					
3000	90	12.1	853	24°	<b>35-7282</b>	14	OO	ON-OFF	48 VDC		
3000	90	12.1	928	32°	<b>35-7283</b>	- 60	- DA	DALI	48 VDC		
3000	90	12.1	778	44°	<b>35-7284</b>	- 81	XB	CASAMBI	48 VDC		
3000	90	8.2	437	8°	<b>35-A073</b>	DN					

## Atom Low Voltage 52 Zoom

IP	WELL				
20		90°	360°		

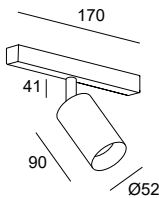

○ ●  
14 60

LED											48VDC
K	CRI	W Total	Real Lm	Optics	Code						
2700	90	12.7	518	Zoom 16°-47°	<b>35-A063</b>	- 14	OO	ON-OFF	48 VDC		
						- 60	- DA	DALI	48 VDC		
							XB	CASAMBI	48 VDC		
3000	90	12.7	551	Zoom 16°-47°	<b>35-A064</b>	- 14	OO	ON-OFF	48 VDC		
						- 60	- DA	DALI	48 VDC		
							XB	CASAMBI	48 VDC		

Atom Low Voltage  
30



Atom Low Voltage  
52



Atom Low Voltage  
52 Zoom



**Controladores**  
Controladores

P. 1166



Regulador DALI Broadcast  
Regulador DALI Broadcast

71-8115-00-00

71-8115-00-00

71-8115-00-00

**Accesorios ópticos**  
Acessórios óticos



Difusor elíptico (5u.)  
Difusor elíptico (5u.)

-

71-6274-00-00

-



Difuminador de halo (5u.)  
Difusor opalino (5u.)

-

71-6275-00-00

-



Conforto visual (1u.)  
Conforto visual (1u.)

14 ○

-

71-6276-14-00

-

60 ●

-

71-6276-60-00

-



Panel de abeja (5u.)  
Painel de abelha (5u.)

60 ●

-

71-6273-60-00

-



Visera  
Viseira

60 ●

-

71-6277-60-00

-



Aro frontal  
Aro frontal

14 ○

-

71-6436-14-00

-

23 ●

-

71-6436-23-00

-

## Kiva Low Voltage 75

UGR				
<16	360°	90°		

○ ● ◐ ◑  
14 60 81 DN

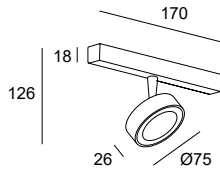
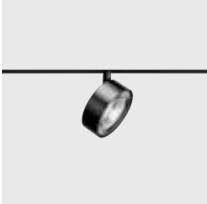

LED								48VDC
K	CRI	W Total	Real Lm	Optics	Code			
2700	90	6.4	458	19°	<b>35-8035</b>	-	<b>14</b> OO ON-OFF 48 VDC <b>60</b> - DA DALI 48 VDC <b>81</b> XB CASAMBI 48 VDC <b>DN</b>	
3000	90	6.4	530	19°	<b>35-8036</b>	-	<b>14</b> OO ON-OFF 48 VDC <b>60</b> - DA DALI 48 VDC <b>81</b> XB CASAMBI 48 VDC <b>DN</b>	

## Kiva Low Voltage 95

UGR				
<16	360°	90°		

○ ● ◐ ◑  
14 60 81 DN

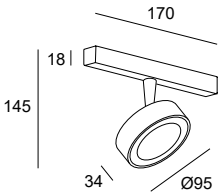

LED								48VDC
K	CRI	W Total	Real Lm	Optics	Code			
2700	90	12	1172	23°	<b>35-8037</b>	-	<b>14</b> OO ON-OFF 48 VDC <b>60</b> - DA DALI 48 VDC <b>81</b> XB CASAMBI 48 VDC <b>DN</b>	
3000	90	12	1320	23°	<b>35-8038</b>	-	<b>14</b> OO ON-OFF 48 VDC <b>60</b> - DA DALI 48 VDC <b>81</b> XB CASAMBI 48 VDC <b>DN</b>	

Kiva Low Voltage 75



Kiva Low Voltage 95



### Controladores

P. 1166



Regulador DALI Broadcast  
Regulador DALI Broadcast

71-8115-00-00

71-8115-00-00













# Iris

## Low Voltage

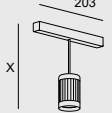

Ejemplo de código / Exemplo de código: **AV19-P6V9U10S60**

Model	W	K / Cri / Real lm	Shade	Optics	Source	Finishes
 	<b>P6</b> 6.3W	<b>V9</b> 2700K / CRI90 / 533 lm	<b>U</b> Hoop   <b>V</b> Visual Comfort 	<b>1</b> 15°  <b>2</b> 35°  <b>3</b> 50°	<b>OS</b> ON-OFF 48 VDC  <b>DS</b> DALI 48 VDC	<b>60</b>  <b>L7</b>  <b>L8</b>  <b>L9</b>  <b>O5</b>  <b>O6</b> 
		<b>W9</b> 3000K / CRI90 / 268 lm				
		<b>X9</b> 4000K / CRI90 / 707 lm 4000K / CRI90 / 461 lm 4000K / CRI90 / 466 lm				
 	<b>12</b> 11.7W	<b>V9</b> 2700K / CRI90 / 1183 lm	<b>X</b> Cone   <b>Y</b> Glass 	<b>OS</b> ON-OFF 48 VDC  <b>DS</b> DALI 48 VDC	<b>OS</b> ON-OFF 48 VDC  <b>DS</b> DALI 48 VDC	
		<b>W9</b> 3000K / CRI90 / 555 lm				
		<b>X9</b> 4000K / CRI90 / 1477 lm 4000K / CRI90 / 966 lm 4000K / CRI90 / 1023 lm				
 	<b>18</b> 17.3W	<b>V9</b> 2700K / CRI90 / 1592 lm	<b>Z</b> Pipe 			
		<b>W9</b> 3000K / CRI90 / 761 lm				
		<b>X9</b> 4000K / CRI90 / 2037 lm 4000K / CRI90 / 1360 lm 4000K / CRI90 / 1422 lm				

\*Consulta las combinaciones de acabados a través del configurador online [iris-ledsc4.com](http://iris-ledsc4.com)

\*Consulte as combinações de acabamentos através do configurador online [iris-ledsc4.com](http://iris-ledsc4.com)

Iris Low Voltage  
SpotlightIris Low Voltage  
DownlightIris Low Voltage  
Pendant

LV

INDOOR

## Controladores

### Controladores

P. 1166



Regulador DALI Broadcast Track Low Voltage  
Regulador DALI Broadcast Track Low Voltage

71-8115-00-00

71-8115-00-00

71-8115-00-00

## Accesorios ópticos

### Accessórios óticos



Difusor elíptico (5u.)  
Difusor elíptico (5u.)

71-5167-00-00

71-5167-00-00

71-5167-00-00



Difusor cuadrado (5u.)  
Difusor quadrado (5u.)

71-5658-00-00

71-5658-00-00

71-5658-00-00



Difuminador de halo (5u.)  
Difusor opalino (5u.)

71-6099-00-00

71-6099-00-00

71-6099-00-00



Panel de abeja (5u.)  
Painel de abelha (5u.)

60 ●

71-5166-60-00

71-5166-60-00

71-5166-60-00



Apantallador (5u.)  
Obturador assimétrico (5u.)

60 ●

71-7895-60-00

71-7895-60-00

71-7895-60-00

BAJA TENSIÓN | BAIXA TENSÃO

# Strom

## Low Voltage

BODY MAT	DIF MAT		50000h	2
AL	PC		L80 B20	MacAdam

### Strom Low Voltage ø55

	IP 20	LOW FLICKER		
--	----------	----------------	--	--

○ ●  
H2 G7

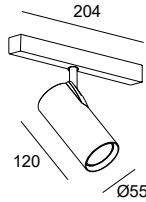

LED											48VDC
K	CRI	W Total	Real Lm	Optics	Code						
3000	90	24	2272	15	35-A166	- H2 - G7	OS	ON-OFF	48 VDC		
3000	90	24	2250	24	35-A167		DS	DALI	48 VDC		
3000	90	24	2227	38	35-A168		XB	CASAMBI	48 VDC		
3500	90	24	2297	15	35-A169	- H2 - G7	OS	ON-OFF	48 VDC		
3500	90	24	2275	24	35-A170		DS	DALI	48 VDC		
3500	90	24	2252	38	35-A171		XB	CASAMBI	48 VDC		
4000	90	24	2362	15	35-A172	- H2 - G7	OS	ON-OFF	48 VDC		
4000	90	24	2339	24	35-A173		DS	DALI	48 VDC		
4000	90	24	2315	38	35-A174		XB	CASAMBI	48 VDC		

### Controladores

P. 1166



Regulador DALI Broadcast  
Regulador DALI Broadcast

71-8115-00-00

## Tango 1 Spot

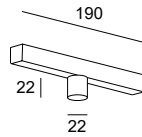

14

LED							48VDC	
K	CRI	W Total	Real Lm	Optics	Code			
2700	90	1.4	145	23	<b>35-A135 - 14</b>	- DA	ON-OFF 48 VDC	
						- DA	DALI-2 48 VDC	
						- XB	CASAMBI 48 VDC	
3000	90	1.4	152	23	<b>35-A136 - 14</b>	- DA	ON-OFF 48 VDC	
						- DA	DALI-2 48 VDC	
						- XB	CASAMBI 48 VDC	

## Tango 2 Spots

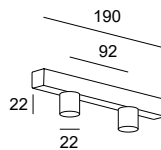

14

LED							48VDC	
K	CRI	W Total	Real Lm	Optics	Code			
2700	90	2.8	283	25	<b>35-A137 - 14</b>	- DA	ON-OFF 48 VDC	
						- DA	DALI 48 VDC	
						- XB	CASAMBI 48 VDC	
3000	90	2.8	297	25	<b>35-A138 - 14</b>	- DA	ON-OFF 48 VDC	
						- DA	DALI 48 VDC	
						- XB	CASAMBI 48 VDC	

**Tango 1 Spot**

**Tango 2 Spots**

## Controladores

P. 1166

 Regulador DALI Broadcast  
 Regulador DALI Broadcast

**71-8115-00-00**
**71-8115-00-00**

# Bento

## Low Voltage

BODY MAT
AL



50000h
L80 B20

3
MacAdam

### Bento Low Voltage 6 LEDs

UGR
<16



○ ●  
14 60

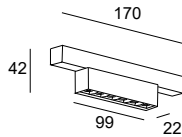

LED										48VDC
K	CRI	W	Total Real Lm	Optics	Code					
2700	90	6	687	26°	<b>15-7885</b>	- 14	-	OO	ON-OFF 48 VDC	
2700	90	6	603	47°	<b>15-A041</b>	- 60	-	DA	DALI 48 VDC	
								XB	CASAMBI 48 VDC	
3000	90	6	687	26°	<b>15-7886</b>	- 14	-	OO	ON-OFF 48 VDC	
3000	90	6	603	47°	<b>15-A042</b>	- 60	-	DA	DALI 48 VDC	
								XB	CASAMBI 48 VDC	

### Bento Low Voltage 12 LEDs

UGR
<16

○ ●  
14 60

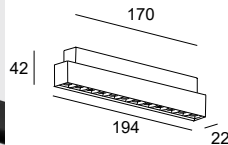

LED										48VDC
K	CRI	W	Total Real Lm	Optics	Code					
2700	90	12	1374	26°	<b>15-7888</b>	- 14	-	OO	ON-OFF 48 VDC	
2700	90	12	1205	47°	<b>15-A043</b>	- 60	-	DA	DALI 48 VDC	
								XB	CASAMBI 48 VDC	
3000	90	12	1374	26°	<b>15-7889</b>	- 14	-	OO	ON-OFF 48 VDC	
3000	90	12	1205	47°	<b>15-A044</b>	- 60	-	DA	DALI 48 VDC	
								XB	CASAMBI 48 VDC	

#### Bento Low Voltage 6 LEDs

#### Bento Low Voltage 12 LEDs



### Controladores

#### Controladores

P. 1166



Regulador DALI Broadcast  
Regulador DALI Broadcast

71-8115-00-00

71-8115-00-00

# Bento

## Low Voltage Wallwasher

BODY MAT
AL



50000h
L80 B20

3
MacAdam

### Bento Low Voltage Wallwasher 6 LEDS



UGR
<10



14 60

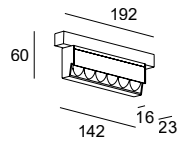
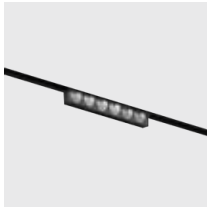

LED							48VDC
K	CRI	W Total	Real Lm	Code			
2700	90	6	421	15-A149	14 - 60	OO ON-OFF 18v - DA DALI 18v XB CASAMBI 18v	
3000	90	6	468	15-A150	14 - 60	OO ON-OFF 18v - DA DALI 18v XB CASAMBI 18v	

### Bento Low Voltage Wallwasher 12 LEDS



UGR
<10



14 60

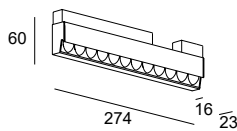
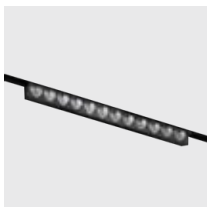

LED							48VDC
K	CRI	W Total	Real Lm	Code			
2700	90	12	829	15-A151	14 - 60	OO ON-OFF 36v - DA DALI 36v XB CASAMBI 36v	
3000	90	12	921	15-A152	14 - 60	OO ON-OFF 36v - DA DALI 36v XB CASAMBI 36v	

Bento Low Voltage Wall Washer 6 LEDS



Bento Low Voltage Wall Washer 12 LEDS



### Controladores

P. 1166



Regulador DALI Broadcast  
Regulador DALI Broadcast

71-8115-00-00

71-8115-00-00



# Nara

BODY MAT
AL

DIF MAT
ACR



50000h
L80 B20

3
MacAdam



○ ●  
14 60

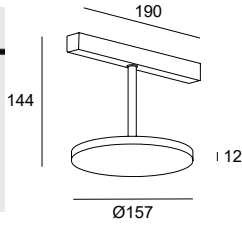

LED							48VDC
K	CRI	W Total	Real Lm	Code			
2700	90	13.4	1074	35-A156	- 14 - 60	OO ON-OFF 48 VDC DA DALI 48 VDC XB CASAMBI 48 VDC	
3000	90	13.4	1130	35-A157	- 14 - 60	OO ON-OFF 48 VDC DA DALI 48 VDC XB CASAMBI 48 VDC	

## Controladores

P. 1166



Regulador DALI Broadcast Track Low Voltage  
Regulador DALI Broadcast Track Low Voltage

71-8115-00-00

## Accesorios ópticos



Accesorio campana textil  
Acessório campânula têxtil

EK ●

71-B233-05-EK

EQ ●

71-B233-05-EQ

# Vela

BODY MAT
AL



50000h
L80 B20

2
MacAdam

UGR
<16



●  
60

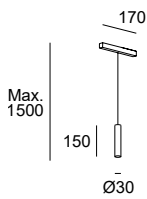
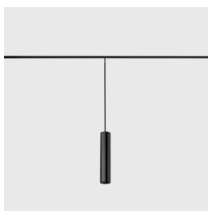

LED							48VDC
K	CRI	W Total	Real Lm	Code			
2700	90	3.1	269	00-7341	- 60 -	OO ON-OFF 48 VDC DA DALI 48 VDC XB CASAMBI 48 VDC	
3000	90	3.1	269	00-7342	- 60 -	OO ON-OFF 48 VDC DA DALI 48 VDC XB CASAMBI 48 VDC	

## Controladores

P. 1166



Regulador DALI Broadcast  
Regulador DALI Broadcast

71-8115-00-00



50000h  
L80 B20

3  
MacAdam

## On Low Voltage 500mm

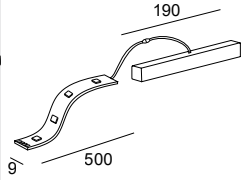
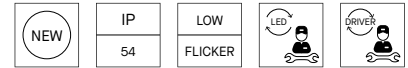

LED					48VDC
K	CRI	W	Real Lm	Code	
2700	90	3.9	407	<b>91-A027 - 00 - DA</b>	
3000	90	3.9	420	<b>91-A028 - 00 - DA</b>	

## On Low Voltage 1000mm

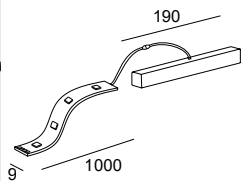
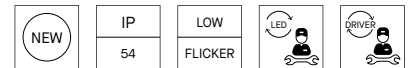

LED					48VDC
K	CRI	W	Real Lm	Code	
2700	90	5.5	574	<b>91-A029 - 00 - DA</b>	
3000	90	5.5	592	<b>91-A030 - 00 - DA</b>	

## On Low Voltage 2000mm

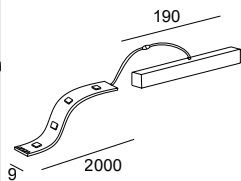
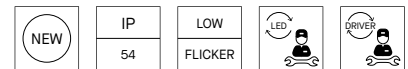

LED					48VDC
K	CRI	W	Real Lm	Code	
2700	90	11.5	1201	<b>91-A031 - 00 - DA</b>	
3000	90	11.5	1238	<b>91-A032 - 00 - DA</b>	

## On Low Voltage 3000mm

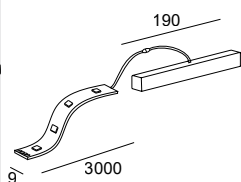
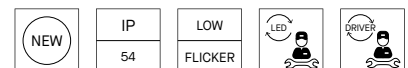

LED					48VDC
K	CRI	W	Real Lm	Code	
2700	90	19.2	2006	<b>91-A033 - 00 - DA</b>	
3000	90	19.2	2068	<b>91-A034 - 00 - DA</b>	

On Low Voltage 500mm



On Low Voltage 1000mm



On Low Voltage 2000mm



On Low Voltage 3000mm



## Accesorios de fijación Acessórios de fixação



Perfil cortable para instalación tira LED (L=xxxxmm)  
Perfil cortável para a instalação de fita LED (L=xxxxmm)

**71-B350-00-00**

**71-B350-00-00**

**71-B350-00-00**

**71-B350-00-00**

# Infinite LV

## Infinite Standard

BODY MAT
AL

DIF MAT
PVC



50000h
L80 B20

3
MacAdam

### Infinite Standard 462mm

UGR
<22

WELL
------

●  
60

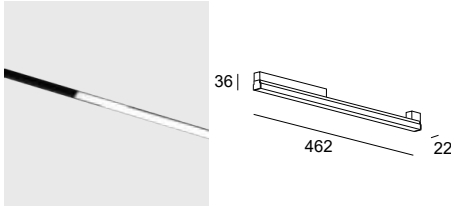

LED							48VDC
K	CRI	W Total	Real Lm	Code			
2700	90	6.8	654	<b>90-7359 - 60</b>	<b>OO</b>	ON-OFF 48 VDC	
					<b>DA</b>	DALI 48 VDC	
					<b>XB</b>	CASAMBI 48 VDC	
3000	90	6.8	654	<b>90-7361 - 60</b>	<b>OO</b>	ON-OFF 48 VDC	
					<b>DA</b>	DALI 48 VDC	
					<b>XB</b>	CASAMBI 48 VDC	

### Infinite Standard 950mm

UGR
<22

WELL
------

●  
60

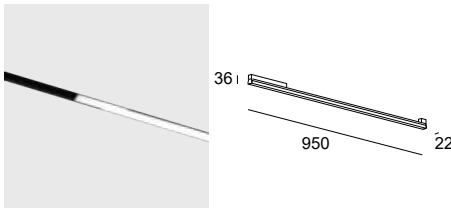

LED							48VDC
K	CRI	W Total	Real Lm	Code			
2700	90	12.6	1208	<b>90-7360 - 60</b>	<b>OO</b>	ON-OFF 48 VDC	
					<b>DA</b>	DALI 48 VDC	
					<b>XB</b>	CASAMBI 48 VDC	
3000	90	12.6	1208	<b>90-7362 - 60</b>	<b>OO</b>	ON-OFF 48 VDC	
					<b>DA</b>	DALI 48 VDC	
					<b>XB</b>	CASAMBI 48 VDC	

Infinite Standard 462mm

Infinite Standard 950mm



### Controladores

Controladores

P. 1166



Regulador DALI Broadcast  
Regulador DALI Broadcast

71-8115-00-00

71-8115-00-00

### Infinite High Output 462mm

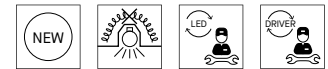

● 60

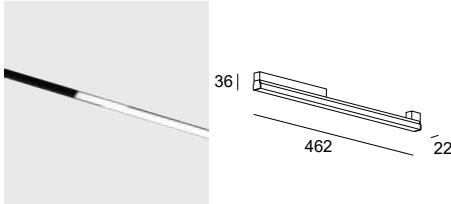

LED						48VDC
K	CRI	W Total	Real Lm	Code		
2700	90	10.5	1361	<b>90-A063 - 60 - DA</b>	OO	ON-OFF 48 VDC
					DA	DALI 48 VDC
					XB	CASAMBI 48 VDC
3000	90	10.5	1353	<b>90-A064 - 60 - DA</b>	OO	ON-OFF 48 VDC
					DA	DALI 48 VDC
					XB	CASAMBI 48 VDC

### Infinite High Output 950mm

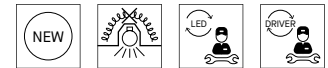

● 60

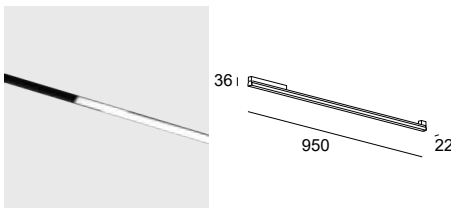

LED						48VDC
K	CRI	W Total	Real Lm	Code		
2700	90	19.2	2715	<b>90-A065 - 60 - DA</b>	OO	ON-OFF 48 VDC
					DA	DALI 48 VDC
					XB	CASAMBI 48 VDC
3000	90	19.2	2697	<b>90-A066 - 60 - DA</b>	OO	ON-OFF 48 VDC
					DA	DALI 48 VDC
					XB	CASAMBI 48 VDC

Infinite High Output 462mm

Infinite High Output 950mm



### Controladores

P. 1166

 Regulador DALI Broadcast  
 Regulador DALI Broadcast

**71-8115-00-00**
**71-8115-00-00**

# Track Low Voltage Surfaced

Esquema de instalación  
Esquema de instalação

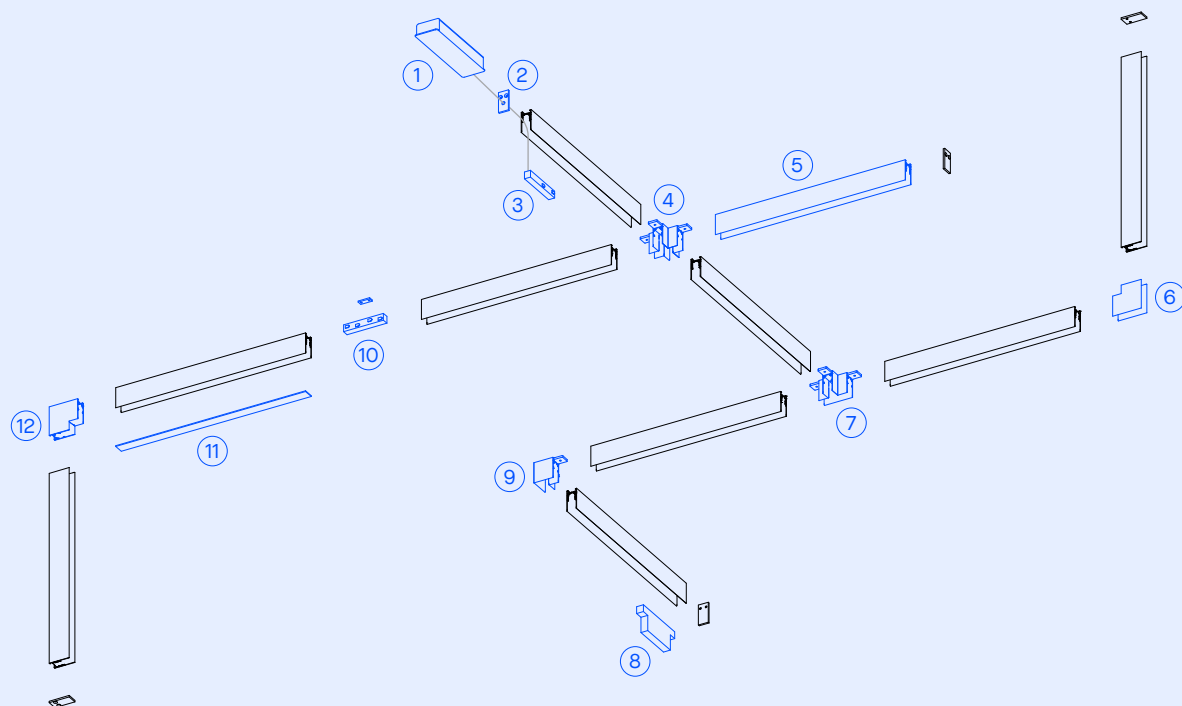

- ① **Remote power source**  
**71-A258-00-00**  
 (48V / 75W)  
**71-A259-00-00**  
 (48V / 120W)  
**71-7646-00-00**  
 (48V / 150W)  
**71-7647-00-00**  
 (48V / 240W)  
**71-7648-00-00**  
 (for DIN 48V / 240W track)  
**71-B077-00-00**  
 (48V / 320W)  
**71-B078-00-00**  
 (48V / 480W)  
**71-B079-00-00**  
 (48V / 620W)

- Built-in power source**  
**71-B440-60-00**  
 (48V / 100W)  
**71-B441-60-00**  
 (48V / 250W)
- ② **End cap**  
**71-7705-00-00**
- ③ **Power connector**  
**71-7637-60-00**
- ④ **X joint**  
**71-A247-60-00**

- ⑤ **Track Low Voltage**  
 1m: **71-7624-60-00**  
 2m: **71-7625-60-00**  
 3m: **71-7626-60-00**
- ⑥ **L Vertical**  
**71-A245-60-00**
- ⑦ **T joint**  
**71-A246-60-00**
- ⑧ **Converter Casambi DALI**  
**71-8115-00-00**
- ⑨ **L joint**  
**71-7627-60-00**
- ⑩ **L joint**  
**71-7627-60-00**

- ⑪ **Black cap**  
 1m: **71-8030-60-00**  
 2m: **71-8031-60-00**  
 3m: **71-8032-60-00**

- ⑫ **L Vertical joint**  
**71-A244-60-00**

# Track Low Voltage Pendant

LV

INDOOR

Esquema de instalación  
Esquema de instalação

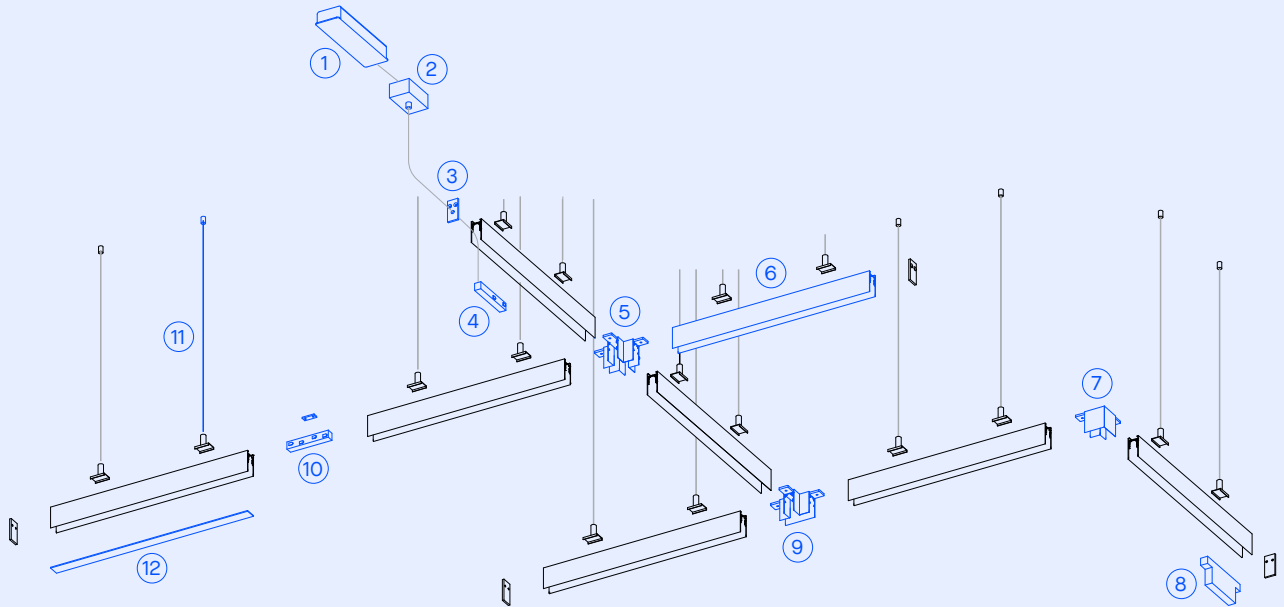

BAJA TENSIÓN | BAIXA TENSÃO

## ① Remote power source

**71-A258-00-00**  
(48V / 75W)  
**71-A259-00-00**  
(48V / 120W)  
**71-7646-00-00**  
(48V / 150W)  
**71-7647-00-00**  
(48V / 240W)  
**71-7648-00-00**  
(for DIN 48V / 240W track)

**71-B077-00-00**  
(48V / 320W)  
**71-B078-00-00**  
(48V / 480W)  
**71-B079-00-00**  
(48V / 620W)

## Built-in power source

**71-B440-60-00**  
(48V / 100W)  
**71-B441-60-00**  
(48V / 250W)

## ② Suspended ceiling

Rose power outlet  
● **71-7520-60-00**  
○ **71-7520-14-00**

## ③ Power connector

**71-7637-60-00**

## ④ Power connector

**71-7637-60-00**

## ⑤ X joint

**71-A247-60-00**

## ⑥ Track Low Voltage

1m: **71-7624-60-00**  
2m: **71-7625-60-00**  
3m: **71-7626-60-00**

## ⑦ L joint

**71-7627-60-00**

## ⑧ Converter Casambi DALI

**71-8115-00-00**

## ⑨ T joint

**71-A246-60-00**

## ⑩ I joint

**71-7629-60-00**

## ⑪ Suspension installation kit

**71-7676-00-00**

## ⑫ Black cap

1m: **71-8030-60-00**  
2m: **71-8031-60-00**  
3m: **71-8032-60-00**



# Track Low Voltage

## Surfaced & Pendant

BODY MAT
AL



### Track Low Voltage Pendant & Surfaced

○ ●  
14 60

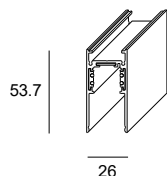

mm

1000  
2000  
3000

Code

71-7624  
71-7625 - 14 - 00  
71-7626 - 60 - 00

### Fuentes de alimentación

#### Fontes de alimentação

P. 1166



ON-OFF  
IP20, Remote

71-A258-00-00



ON-OFF  
IP20, Remote

71-A259-00-00



ON-OFF  
IP67, Remote

71-7646-00-00



ON-OFF  
IP67, Remote

71-7647-00-00



ON-OFF  
IP67, Remote

71-7648-00-00



ON-OFF  
IP67, Remote

71-B077-00-00



ON-OFF  
IP67, Remote

71-B078-00-00



ON-OFF  
IP67, Remote

71-B079-00-00



ON-OFF  
IP20, Built-in

71-B440-60-00



ON-OFF  
IP20, Built-in

71-B441-60-00

### Controladores

#### Controladores

P. 1166



Regulador DALI Broadcast Track Low Voltage  
Regulador DALI Broadcast Track Low Voltage

71-8115-00-00

### Accesorios de fijación requeridos

#### Acessórios de fixação requeridos



Florón suspendido con toma de corriente ON-OFF  
Florão suspenso com tomada de corrente ON-OFF

14 ○

71-7520-14-00

60 ●

71-7520-60-00

## Accesorios de fijación

### Accessórios de fixação



Kit instalación  
Kit instalação

71-7676-00-00

## Accesorios de unión

### Accessórios de união



Unión "I"  
União "I"

14 ○

71-7629-14-00

60 ●

71-7639-60-00



Unión "T"  
União "T"

14 ○

71-A246-14-00

60 ●

71-A246-60-00



Unión 90°  
União 90°

14 ○

71-7627-14-00

60 ●

71-7627-60-00



Unión "L" vertical interior  
União "L" vertical interior

14 ○

71-A244-14-00

60 ●

71-A244-60-00



Unión "L" vertical exterior  
União "L" vertical exterior

14 ○

71-A245-14-00

60 ●

71-A245-60-00



Tapa frontal embellecedora 1000mm  
Tampa frontal embelezadora 1000mm

14 ○

71-8030-14-00

60 ●

71-8030-60-00

Tapa frontal embellecedora 2000mm  
Tampa frontal embelezadora 2000mm

14 ○

71-8031-14-00

60 ●

71-8031-60-00

Tapa frontal embellecedora 3000mm  
Tampa frontal embelezadora 3000mm

14 ○

71-8032-14-00

60 ●

71-8032-60-00



Tapa pasacables + tapa ciega  
Tampa passa-cabos + tampa cega

14 ○

71-7705-14-00



Unión "X"  
União "X"

14 ○

71-A247-14-00

60 ●

71-A247-60-00

## Accesorios de conexión

### Accessórios de conexão



Conector alimentación  
Conetor alimentação

14 ○

71-7637-14-00

60 ●

71-7637-60-00

# Track Low Voltage Recessed

Esquema de instalación  
Esquema de instalação

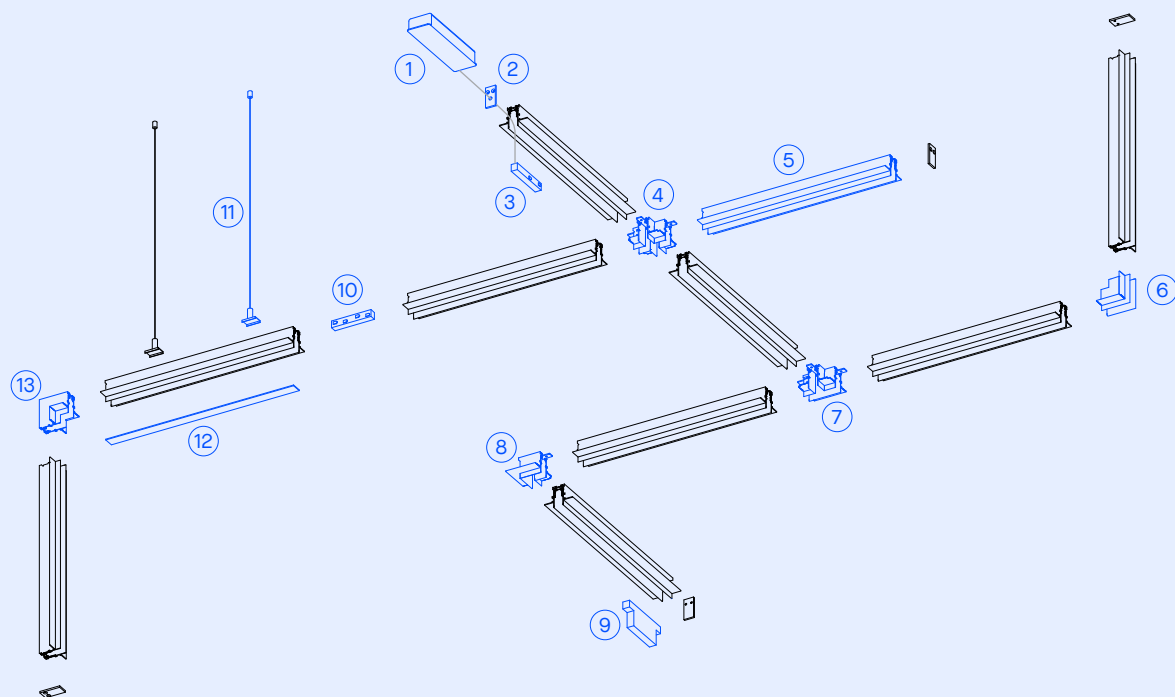

① **Remote power source**

**71-A258-00-00**  
(48V / 75W)  
**71-A259-00-00**  
(48V / 120W)  
**71-7646-00-00**  
(48V / 150W)  
**71-7647-00-00**  
(48V / 240W)  
**71-7648-00-00**  
(for DIN 48V / 240W  
track)  
**71-B077-00-00**  
(48V / 320W)  
**71-B078-00-00**  
(48V / 480W)  
**71-B079-00-00**  
(48V / 620W)

**Built-in power source**

**71-B440-60-00**  
(48V / 100W)  
**71-B441-60-00**  
(48V / 250W)

② **End cap**  
**71-7705-00-00**

③ **Power connector**  
**71-7637-60-00**

④ **X joint**  
**71-A251-60-00**

⑤ **Track Low Voltage**  
1m: **71-7630-60-00**  
2m: **71-7631-60-00**  
3m: **71-7632-60-00**

⑥ **L Vertical joint**  
**71-A249-60-00**

⑦ **T joint**  
**71-A250-60-00**

⑧ **Converter Casambi DALI**  
**71-8115-00-00**

⑨ **L joint**  
**71-7706-60-00**

⑩ **I joint**  
**71-7633-60-00**

⑪ **Suspension  
installation kit**  
**71-7676-00-00**

⑫ **Black cap**  
1m: **71-8030-60-00**  
2m: **71-8031-60-00**  
3m: **71-8032-60-00**

⑬ **L Vertical joint**  
**71-A248-60-00**

# Track Low Voltage Recessed

BODY MAT  
AL



LV

INDOOR

## Track Low Voltage Recessed

○ ●  
14 60

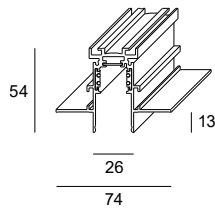

mm

1000  
2000  
3000

Code

71-7630  
71-7631 - 14 - 00  
71-7632 - 60 - 00

54x3000 3-13 mm

## Fuentes de alimentación Fontes de alimentação

P. 1166

	ON-OFF IP20, Remote	71-A258-00-00
	ON-OFF IP20, Remote	71-A259-00-00
	ON-OFF IP67, Remote	71-7646-00-00
	ON-OFF IP67, Remote	71-7647-00-00
	ON-OFF IP67, Remote	71-7648-00-00
	ON-OFF IP67, Remote	71-B077-00-00
	ON-OFF IP67, Remote	71-B078-00-00
	ON-OFF IP67, Remote	71-B079-00-00
	ON-OFF IP20, Built-in	71-B440-60-00
	ON-OFF IP20, Built-in	71-B441-60-00

## Controladores Controladores

P. 1166

	Regulador DALI Broadcast Regulador DALI Broadcast	71-8115-00-00
--	------------------------------------------------------	---------------

BAJA TENSIÓN | BAIXA TENSÃO

## Accesorios de fijación

### Acessórios de fixação



Kit instalación  
Kit instalação

71-8124-00-00



Kit de instalación  
Kit de instalação

71-7634-00-00

## Accesorios de unión

### Acessórios de união



Unión "I"  
União "I"

14 ○

71-7633-14-00

60 ●

71-7633-60-00



Unión "T"  
União "T"

14 ○

71-A250-14-00

60 ●

71-A250-60-00



Unión "X"  
União "X"

14 ○

71-A251-14-00

60 ●

71-A251-60-00



Unión 90°  
União 90°

14 ○

71-7706-14-00

60 ●

71-7706-60-00



Unión "L" vertical interior  
União "L" vertical interior

14 ○

71-A248-14-00

60 ●

71-A248-60-00



Unión "L" vertical exterior  
União "L" vertical exterior

14 ○

71-A249-14-00

60 ●

71-A249-60-00



Tapa frontal embellecedora 1000mm  
Tapa frontal embelezadora 1000mm

14 ○

71-8030-14-00

60 ●

71-8030-60-00

Tapa frontal embellecedora 2000mm  
Tapa frontal embelezadora 2000mm

14 ○

71-8031-14-00

60 ●

71-8031-60-00

Tapa frontal embellecedora 3000mm  
Tapa frontal embelezadora 3000mm

14 ○

71-8032-14-00

60 ●

71-8032-60-00



Tapa pasacables + tapa ciega  
Tapa passa-cabos + tampa cega

14 ○

71-7705-14-00

60 ●

71-7705-00-00

## Accesorios de conexión

### Acessórios de conexão



Conector alimentación  
Conetor alimentação

14 ○

71-7637-14-00

60 ●

71-7637-60-00

# Track Low Voltage Up & Down

LV

INDOOR

Esquema de instalação  
Esquema de instalação

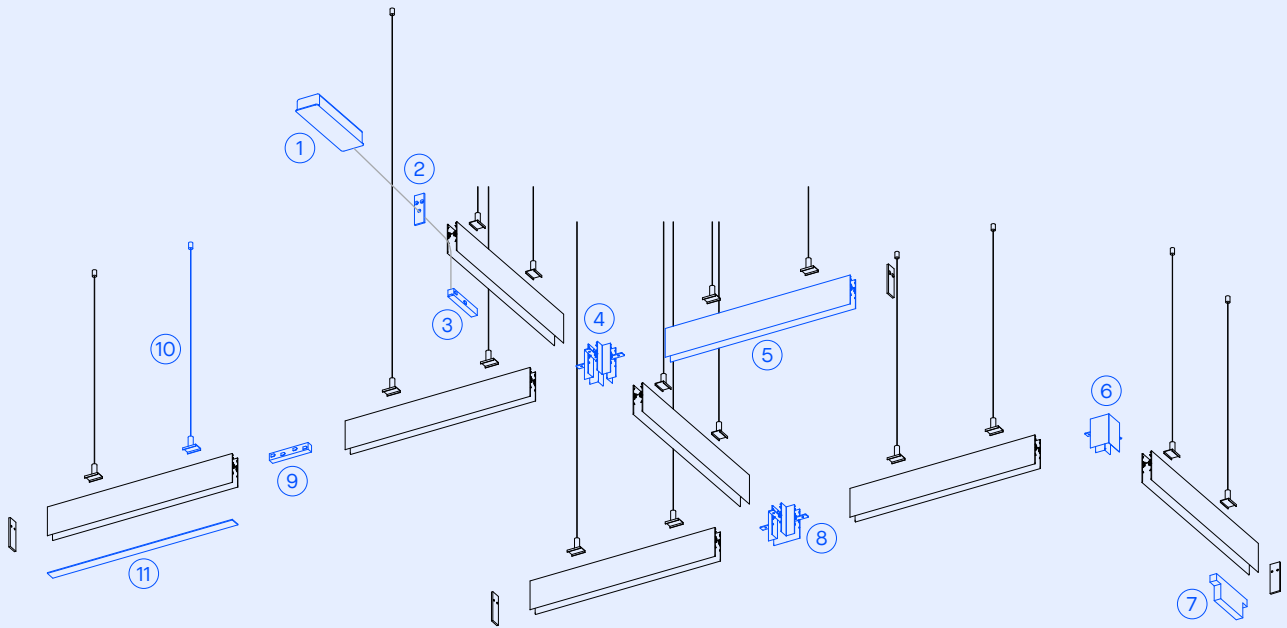

BAJA TENSIÓN | BAIXA TENSÃO

## ① Remote power source

**71-A258-00-00**  
(48V / 75W)  
**71-A259-00-00**  
(48V / 120W)  
**71-7646-00-00**  
(48V / 150W)  
**71-7647-00-00**  
(48V / 240W)  
**71-7648-00-00**  
(for DIN 48V / 240W track)  
**71-B077-00-00**  
(48V / 320W)  
**71-B078-00-00**  
(48V / 480W)  
**71-B079-00-00**  
(48V / 620W)

## Built-in power source

**71-B440-60-00**  
(48V / 100W)  
**71-B441-60-00**  
(48V / 250W)  
  
② Track end cap  
**71-8046-60-00**  
**71-8045-14-00**  
  
③ Power connector  
**71-7637-60-00**  
**71-7637-14-00**  
  
④ X joint  
**71-A253-60-00**  
**71-A253-14-00**

## ⑤ Track Low Voltage

1m: **71-8043-60-00**  
1m: **71-8043-14-00**  
2m: **71-8044-60-00**  
2m: **71-8044-14-00**  
3m: **71-8045-60-00**  
3m: **71-8045-14-00**

## ⑥ L joint

**71-8047-60-00**  
**71-8047-14-00**

## ⑦ Converter Casambi DALI

**71-8115-00-00**

## ⑧ T joint

**71-A252-60-00**  
**71-A252-14-00**

## ⑨ I joint

**71-7633-60-00**  
**71-7633-14-00**

## ⑩ Suspension installation kit

**71-8124-00-00**

## ⑪ Black cap

1m: **71-8030-60-00**  
1m: **71-8030-14-00**  
2m: **71-8031-60-00**  
2m: **71-8031-14-00**  
3m: **71-8032-60-00**  
3m: **71-8032-14-00**



# Track Low Voltage

## Up&Down

BODY MAT
AL



### Track Low Voltage Up&Down

○ ●  
14 60

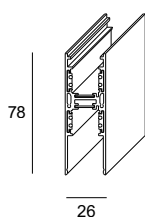

mm

1000  
2000  
3000

Code

71-8043  
71-8044 - 14 - 00  
71-8045 - 60 - 00

### Fuentes de alimentación

#### Fontes de alimentação

P. 1166



ON-OFF  
IP20, Remote

71-A258-00-00



ON-OFF  
IP20, Remote

71-A259-00-00



ON-OFF  
IP67, Remote

71-7646-00-00



ON-OFF  
IP67, Remote

71-7647-00-00



ON-OFF  
IP67, Remote

71-7648-00-00



ON-OFF  
IP67, Remote

71-B077-00-00



ON-OFF  
IP67, Remote

71-B078-00-00



ON-OFF  
IP67, Remote

71-B079-00-00



ON-OFF  
IP20, Built-in

71-B440-60-00



ON-OFF  
IP20, Built-in

71-B441-60-00

### Controladores

#### Controladores

P. 1166





Regulador DALI Broadcast Track Low Voltage  
Regulador DALI Broadcast Track Low Voltage

71-8115-00-00

## Accesorios de fijación requeridos

### Acessórios de fixação requeridos

	Florón suspendido con toma de corriente ON-OFF Florão suspenso com tomada de corrente ON-OFF	14 ○	71-7520-14-00
		60 ●	71-7520-60-00
	Florón suspendido con toma de corriente DALI Florão suspenso com tomada de corrente DALI	14 ○	71-7521-14-00
		60 ●	71-7521-60-00







## Accesorios de fijación

### Acessórios de fixação

	Kit instalación Kit instalação		71-8124-00-00
-----------------------------------------------------------------------------------	-----------------------------------	--	---------------

## Accesorios de unión

### Acessórios de união

	Unión "I" União "I"	14 ○	71-7633-14-00
		60 ●	71-7633-60-00
	Unión "L" União "L"	14 ○	71-8047-14-00
		60 ●	71-8047-60-00
	Unión "T" União "T"	14 ○	71-A252-14-00
		60 ●	71-A252-60-00
	Unión "X" União "X"	14 ○	71-A253-14-00
		60 ●	71-A253-60-00
	Tapa frontal embellecedora 1000mm Tampa frontal embelezadora 1000mm	14 ○	71-8030-14-00
		60 ●	71-8030-60-00
	Tapa frontal embellecedora 2000mm Tampa frontal embelezadora 2000mm	14 ○	71-8031-14-00
		60 ●	71-8031-60-00
	Tapa frontal embellecedora 3000mm Tampa frontal embelezadora 3000mm	14 ○	71-8032-14-00
		60 ●	71-8032-60-00
	Tapas ciegas (2u.) Tampas cegas (2u.)	14 ○	71-8046-14-00
		60 ●	71-8046-60-00

## Accesorios de conexión

### Acessórios de conexão

	Conector alimentación Conetor alimentação	14 ○	71-7637-14-00
		60 ●	71-7637-60-00

# Downlights

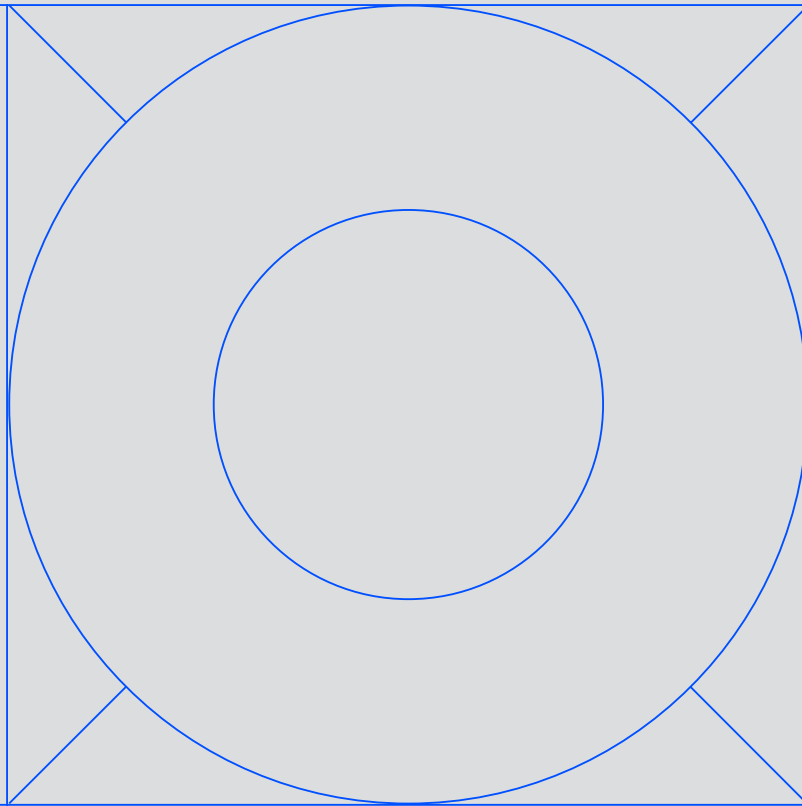

Sia  
162

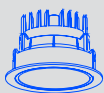

Biwa  
182



Veo  
186

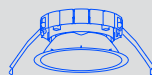

Vol  
191



Play  
194



Lite  
226

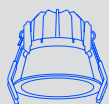

Dome  
232

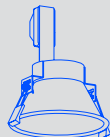

Ges  
233



Bento  
236

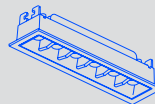

Luno  
252

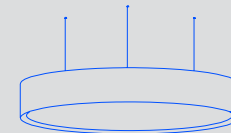

Multidir Evo  
254

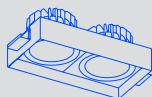

Totem  
264

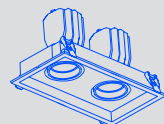

Ecofit  
266

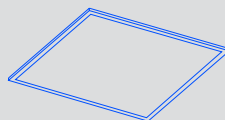

Kiva  
276



# Sia

Designed by LedsC4 Architectural



+ Sia



Sia es un downlight con gran capacidad de adaptación al espacio gracias a la amplitud de versiones de cada modelo. Con un alto rendimiento, proporciona una luz uniforme que puede modularse fácilmente debido a la cantidad de lentes disponibles.

Sia é um downlight com uma grande capacidade de adaptação ao espaço graças à vasta gama de versões de cada modelo. Com um alto rendimento, proporciona uma luz muito uniforme que pode ser facilmente modulada devido à quantidade de lentes disponíveis.

**Máximo rendimiento y confort,  
Sia proyecta una luz que se  
adapta al espacio**

**Máximo rendimento e  
conforto, Sia projeta uma luz  
que se adapta ao espaço**



Sia Standard en Oficinas Verdissimo. Su reducido deslumbramiento (UGR<19) la convierte en la solución ideal para iluminar espacios de trabajo.

Sia Standard nos Escritórios Verdissimo. O seu reduzido deslumbramento (UGR<19) torna-a a solução ideal para iluminar espaços de trabalho.

Sia Standard

168

Ø 115 mm



Sia Adjustable

173

Ø 115 mm



Sia Lens

177

Ø 115 mm



Ø 170 mm



Ø 180 mm



Ø 225 mm



12- 33, 4W



Ultra Wide Flood 80°

Trim



14 60

Trimless



WT

12-33.4 W



Extra Spot 18° - Extra Medium 38°

Trim



14 60

Trimless



WT

12-17.7 W



Wall Washer - Batwing - Square - Narrow

Trim



WR WN

Trimless



WP WQ





Gran capacidad gracias a sus múltiples opciones de instalación y formas, tanto en las versiones fijas como en las ajustables  
Grande capacidade graças às suas múltiplas opções de instalação e formas, tanto nas versões fixas como nas ajustáveis



- ① Standard Square Trimless
- ② Standard Round Trimless
- ③ Adjustable Round Trimless
- ④ Standard Square Trim
- ⑤ Standard Round Trim
- ⑥ Adjustable Round Trim
- ⑦ Lens Wall Washer

# Sia Adjustable

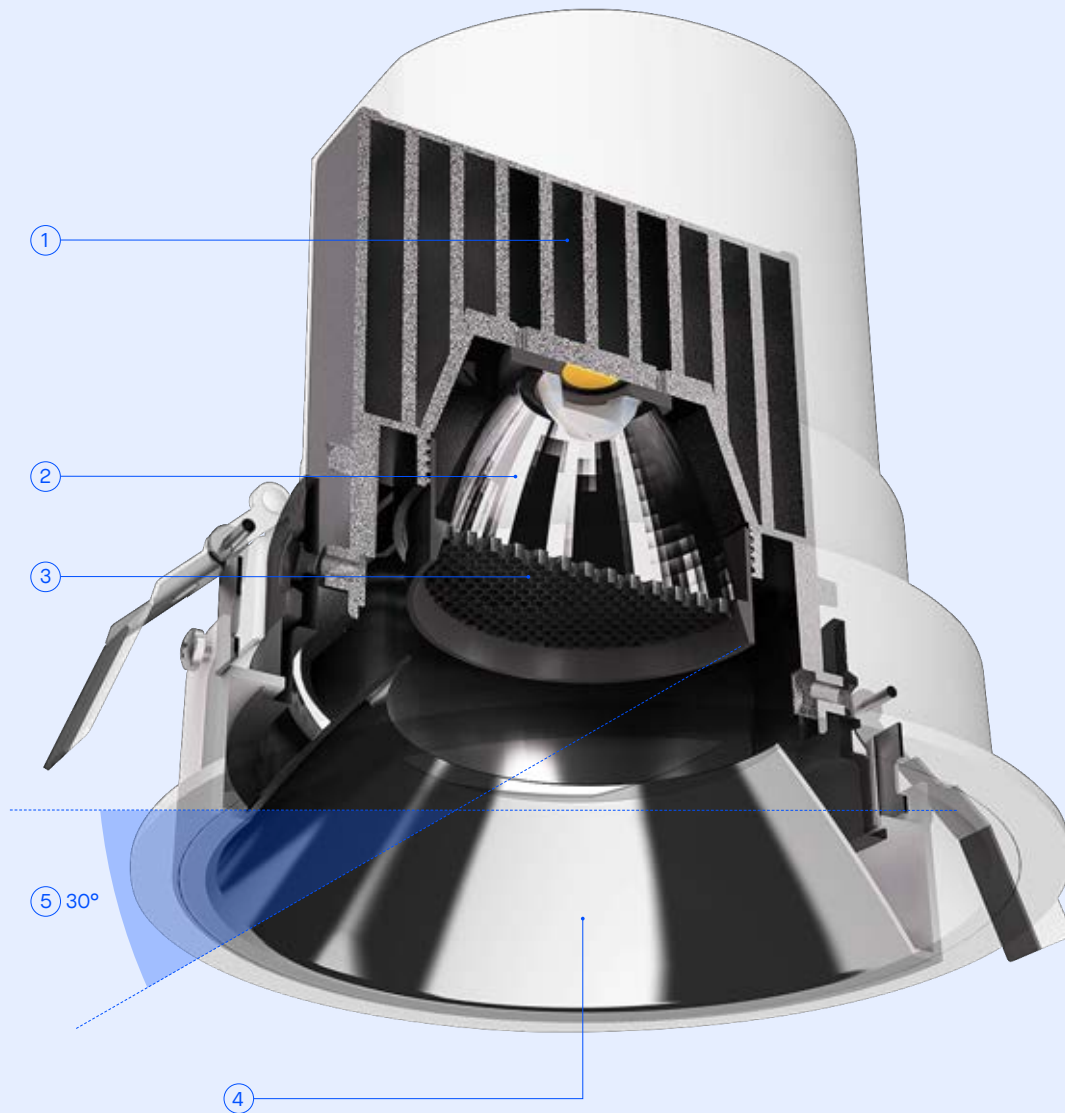

① Disipador térmico  
Dissipador térmico

② Reflector de alto confort  
Refletor de alto conforto

③ Accesorios:  
Acessórios:  
Panel de abeja  
Painel de abelha  
Difusor elíptico  
Difusor elíptico  
Difusor cuadrado  
Difusor quadrado  
Difusor opal  
Difusor opalino

④ Reflector secundario  
cromado por alto vacío  
Refletor secundário  
cromado por alto vacío

⑤ Ángulo cut-off 30° que  
evita el deslumbramiento  
Ângulo cut-off 30° que  
evita el deslumbramiento

## Funcionalidades Smart

### Funcionalidade Smart

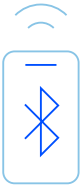

Mediante drivers conectivos, ya sean Bluetooth Mesh o D4i, Sia puede regularse con interacción selectiva con la luz y diversas funcionalidades como ahorro energético por ocupación, programación horaria o sistemas de aprovechamiento de la luz natural.

Através de drivers conectivos, quer seja Bluetooth Mesh ou D4i, Sia pode ser regulada com interação seletiva com a luz e várias funcionalidades como poupança de energia por ocupação, programação horária ou sistemas de aproveitamento da luz natural.



### Módulo emergencia exclusivo

### Módulo emergência exclusivo

Consultar opciones P. 000  
Consultar opções p. XXX





# Sia Standard



Versión con óptica fija que se adapta a cada necesidad y proyecto  
 Versão com ótica fixa que se adapta a cada necessidade e projeto

**Disponibile en 3 medidas**  
 Disponível em 3 medidas



Small (Ø115)



Big (Ø170)



XL (Ø225)

Ángulo Ultra Wide Flood  
 Ângulo Ultra Wide flood

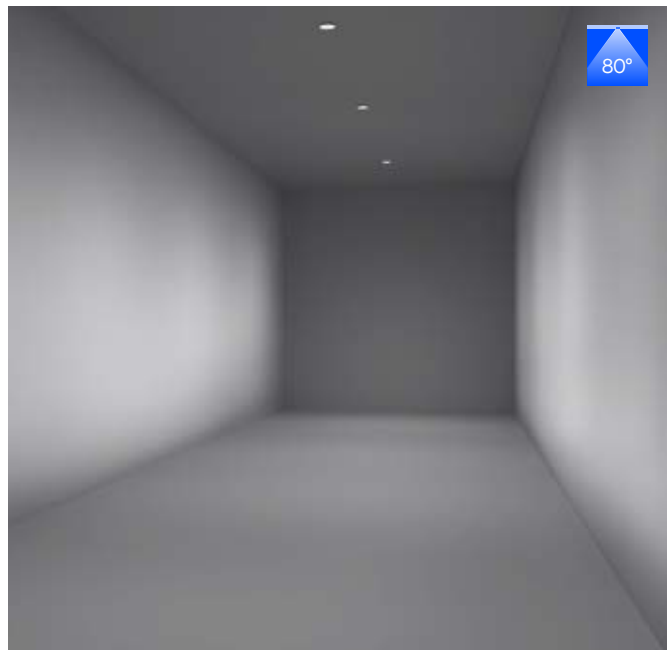

UGR <19

# Sia Standard

BODY MAT	DIF MAT	50000h	2
AL	PMMA	L80 B20	MacAdam

## Sia Standard 115

IP	WELL		
54			

Ejemplo de código / Exemplo de código: **AH11-12V8W10U14**

Model	W	K / Cri / Real lm	Optics	Source	Finishes
<b>AH11 -</b> Redondo / Pequeño / Con Marco Redondo / Pequeno / Com Aro 0-16 mm  100   75 Ø 115	12 12W	<b>V8</b> 2700K / CRI80 / 1407 lm	<b>W1</b> 76°	<b>OU</b> ON-OFF 100-240V	<b>14</b> <b>60</b> <b>WT</b>
		<b>W8</b> 3000K / CRI80 / 1407 lm		<b>DS</b> DALI-2 100-240V	
		<b>W9</b> 3000K / CRI90 / 1261 lm		<b>BB</b> 36V/max.350mA	
		<b>X8</b> 4000K / CRI80 / 1401 lm			
<b>AH13 -</b> Cuadrado / Pequeño / Con Marco Quadrado / Pequeno / Com Aro 0-16 mm  100x100   75 Ø 116	17 17.7W	<b>V8</b> 2700K / CRI80 / 1829 lm	<b>W1</b> 76°	<b>OU</b> ON-OFF 100-240V	
		<b>W8</b> 3000K / CRI80 / 1829 lm		<b>DS</b> DALI-2 100-240V	
		<b>W9</b> 3000K / CRI90 / 1646 lm		<b>BB</b> 36V/max.500mA	
		<b>X8</b> 4000K / CRI80 / 1822 lm			
<b>AH12 -</b> Redondo / Pequeño / Sin Marco Redondo / Pequeno / Sem Aro 0-16 mm  96   75 Ø96					WT
<b>AH14 -</b> Cuadrado / Pequeño / Sin Marco Quadrado / Pequeno / Sem Aro 0-16 mm  97x97   75 Ø 97					WT

DOWNLIGHTS



Sia emergency  
 ⓘ P.1036



# Sia Standard 170



Ejemplo de código / Exemplo de código: **AH15-25V8W10U14**

Model	W	K / Cri / Real lm	Optics	Source	Finishes
<b>AH15 -</b> Redondo / Grande / Con Marco Redondo / Grande / Com Aro ≡ 0-16 mm ≡ 150	<b>25</b> 25W	<b>V8</b> 2700K / CRI80 / 2840 lm	<b>W1</b> 79°	<b>OU</b> ON-OFF 100-240V	<b>14</b> <b>60</b> <b>WT</b>
		<b>W8</b> 3000K / CRI80 / 2840 lm		<b>DS</b> 1-10V/PUSH/DALI 220-240V	
		<b>W9</b> 3000K / CRI90 / 2572 lm		<b>BB</b> 36V/max.700mA	
		<b>X8</b> 4000K / CRI80 / 2858 lm			
<b>AH17 -</b> Cuadrado / Grande / Con Marco Quadrado / Grande / Com Aro ≡ 0-16 mm ≡ 150x150	<b>33</b> 33.4W	<b>V8</b> 2700K / CRI80 / 3459 lm	<b>W1</b> 79°	<b>OU</b> ON-OFF 100-240V	
		<b>W8</b> 3000K / CRI80 / 3459 lm		<b>DS</b> 1-10V/PUSH/DALI 220-240V	
		<b>W9</b> 3000K / CRI90 / 3133 lm		<b>BB</b> 36V/max.900mA	
		<b>X8</b> 4000K / CRI80 / 3481 lm			
<b>AH16 -</b> Redondo / Grande / Sin Marco Redondo / Grande / Sem Aro ≡ 0-16 mm ≡ 141					○ WT
<b>AH18 -</b> Cuadrado / Grande / Sin Marco Quadrado / Grande / Sem Aro ≡ 0-16 mm ≡ 144x144					○ WT



Sia emergency  
 ⓘ P.1036

IP	UGR	WELL		
54	<22			

Ejemplo de código / Exemplo de código: **AH19-37W8W10U14**

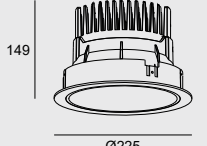
Model	W	K / Cri / Real lm	Optics	Source	Finishes	
<b>AH19 -</b> Redondo / Super Grande / Con Marco Redondo / Super Grande / Com Aro 0-16 mm  215  	<b>37</b> 37W	<b>W8</b> 3000K / CRI80 / 3548 lm	<b>W1</b> 76°	<b>OU</b> ON-OFF 100-240V	<b>14</b> <b>60</b> <b>WT</b>	
		<b>W9</b> 3000K / CRI90 / 3080 lm				<b>DS</b> 1-10V/PUSH/DALI 220-240V
		<b>X8</b> 4000K / CRI80 / 3548 lm				<b>BB</b> 36V/ max.1000mA
	<b>44</b> 44.5W	<b>W8</b> 3000K / CRI80 / 4102 lm		<b>OU</b> ON-OFF 100-240V		
		<b>W9</b> 3000K / CRI90 / 3560 lm				<b>DS</b> DALI 100-277V
		<b>X8</b> 4000K / CRI80 / 4102 lm				<b>BB</b> 36V/max.1200mA

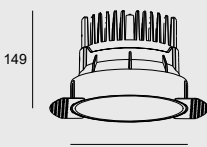
<b>AH21 -</b> Redondo / Super Grande / Sin Marco Redondo / Super Grande / Sem Aro 0-16 mm  190  	<b>WT</b>
--------------------------------------------------------------------------------------------------------------------------------------------------------------------------------------------------------------------------------------------------------------------------------	-----------



**Sia emergency**  
 P.1036

INDOOR

DOWNLIGHTS

Sia Standard 115 12W      Sia Standard 115 17W      Sia Standard 170 33W



**Drivers**  
Driver

P. 1166



ON-OFF  
IP20

71-6652-00-00

71-6142-00-00

71-3542-00-00



PHASE CUT 240V  
IP20

71-A297-00-00

71-4898-00-00

-



1-10V  
PUSH  
IP20

71-7710-00-00

71-7710-00-00

71-4708-00-00



DALI D4i  
DALI2  
IP20

-

-

-



DALI2  
IP20

71-B407-00-00

71-B407-00-00

71-A303-00-00



CASAMBI  
IP20

71-A260-00-00

71-A260-00-00

71-A260-00-00

Sia Standard 170 25W

Sia Standard 225 37W

Sia Standard 225 44W



**Drivers**  
Driver

P. 1166



ON-OFF  
IP20

71-6653-00-00

71-6661-00-00

-



PHASE CUT 240V  
IP20

71-A299-00-00

71-7716-00-00

-



1-10V  
PUSH  
IP20

71-4708-00-00

71-4708-00-00

-



DALI D4i  
DALI2  
IP20

71-7737-00-00

-

-



DALI2  
IP20

71-A192-00-00

71-A303-00-00

-



CASAMBI  
IP20

71-A260-00-00

71-A261-00-00

71-A261-00-00

# Sia Adjustable



Downlight orientable con gran versatilidad de uso. Presenta versiones con distintas aperturas del haz de luz: narrow, spot o medium  
Sia Adjustable é um downlight orientável com grande versatilidade de uso. Apresenta versões com diferentes aberturas do feixe de luz: narrow, spot ou medium

## Accesorios para modular la luz Acessórios para modular a luz

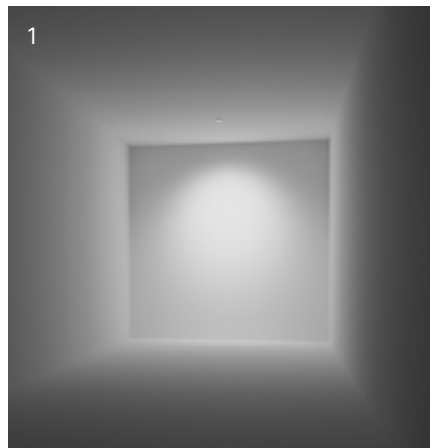

1  
Panel de abeja  
Painel de abelha

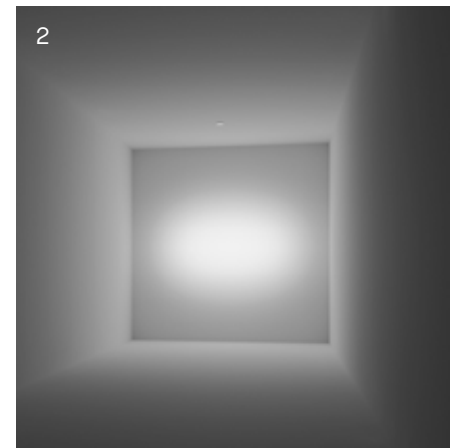

2  
Difusor elíptico  
Difusor elíptico

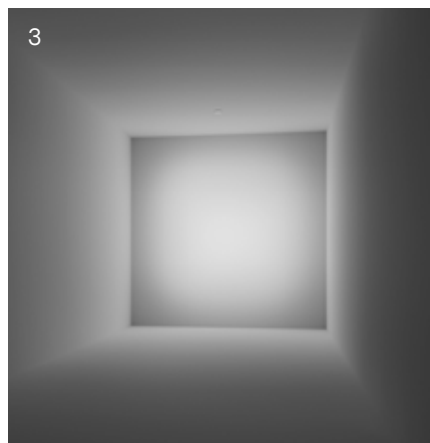

3  
Difusor cuadrado  
Difusor quadrado

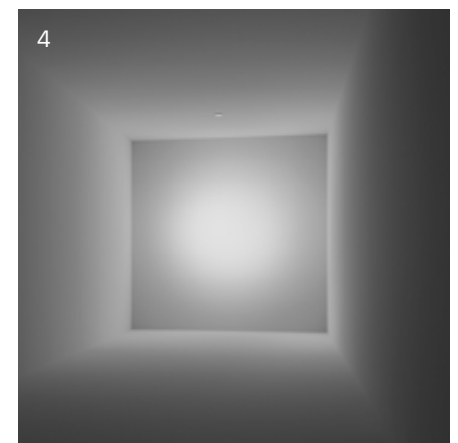







4  
Difusor opal  
Difusor opalino

BODY MAT	DIF MAT	50000h	2
AL	PMMA	L80 B20	MacAdam

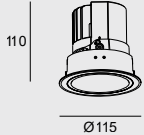
Sia Adjustable 115

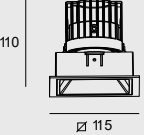
IP	UGR	WELL			
23	<22			360°	

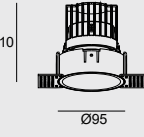

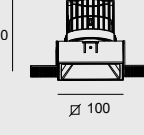

Ejemplo de código / Exemplo de código: AH31-12V8S30U14

Model	W	K / Cri / Real lm	Optics	Source	Finishes
<b>AH31 -</b> Redondo / Pequeño / Con Marco Redondo / Pequeno / Com Aro ≍ 0-20 mm ≍ 105 ≍ 30° ≍ 320°  	12 12W	<b>V8</b> 2700K / CRI80 / 1075 lm	<b>S3</b> 20°  <b>M3</b> 39°	<b>OU</b> ON-OFF 100-240V	<b>14</b> <b>60</b> <b>WT</b>
		<b>W8</b> 3000K / CRI80 / 1075 lm		<b>DS</b> DALI-2 100-240V	
		<b>W9</b> 3000K / CRI90 / 979 lm		<b>BB</b> 36V/max.350mA	
		<b>X8</b> 4000K / CRI80 / 1128 lm			
<b>AH33 -</b> Cuadrado / Pequeño / Con Marco Quadrado / Pequeno / Com Aro ≍ 0-20 mm ≍ 102x102 ≍ ± 30° ≍ 360°  	17 18W	<b>V8</b> 2700K / CRI80 / 1463 lm	<b>S3</b> 20°  <b>M3</b> 39°	<b>OU</b> ON-OFF 100-240V	
		<b>W8</b> 3000K / CRI80 / 1463 lm		<b>DS</b> DALI-2 100-240V	
		<b>W9</b> 3000K / CRI90 / 1335 lm		<b>BB</b> 36V/max.500mA	
		<b>X8</b> 4000K / CRI80 / 1538 lm			
<b>AH32 -</b> Redondo / Pequeño / Sin Marco Redondo / Pequeno / Sem Aro ≍ 0-20 mm ≍ 95 ≍ 30° ≍ 320°  					WT
<b>AH34 -</b> Cuadrado / Pequeño / Sin Marco Quadrado / Pequeno / Sem Aro ≍ 0-20 mm ≍ 100x100 ≍ ± 30° ≍ 360°  					WT

# Sia Adjustable 170

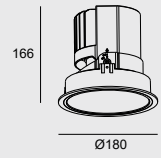
IP	UGR	WELL			
23	<13			360°	

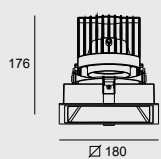
Ejemplo de código / Exemplo de código: AH35-25V8S30U14

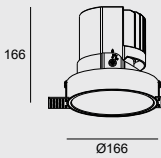
Model	W	K / Cri / Real lm	Optics	Source	Finishes
<b>AH35 -</b> Redondo / Grande / Con Marco Redondo / Grande / Com Aro 0-20 mm Ø 170 ↗30° ↻320°  	25 25W	<b>V8</b> 2700K / CRI80 / 1984 lm	<b>S3</b> 19°	<b>OU</b> ON-OFF 100-240V	14 60 WT
		<b>W8</b> 3000K / CRI80 / 1810 lm	<b>M2</b> 28°	<b>DS</b> 1-10V/PUSH/DALI 220-240V	
		<b>W9</b> 3000K / CRI90 / 1621 lm	<b>M3</b> 38°	<b>BB</b> 36V/max.700mA	
		<b>X8</b> 4000K / CRI80 / 1868 lm			
<b>AH37 -</b> Cuadrado / Grande / Con Marco Cuadrado / Grande / Com Aro 0-20 mm 167x167 ↻ ± 30° ↻360°  	33 33.8W	<b>V8</b> 2700K / CRI80 / 2401 lm	<b>S3</b> 19°	<b>OU</b> ON-OFF 100-240V	
		<b>W8</b> 3000K / CRI80 / 2188 lm	<b>M2</b> 28°	<b>DS</b> 1-10V/PUSH/DALI 220-240V	
		<b>W9</b> 3000K / CRI90 / 1935 lm	<b>M3</b> 38°	<b>BB</b> 36V/max.900mA	
		<b>X8</b> 4000K / CRI80 / 2230 lm			
<b>AH36 -</b> Redondo / Grande / Sin Marco Redondo / Grande / Sem Aro 0-20 mm Ø 166 ↗30° ↻320°  					WT









Sia Adjustable 115 12W    Sia Adjustable 115 17W    Sia Adjustable 170 25W    Sia Adjustable 170 33W



## Drivers





P. 1166

### Driver

	ON-OFF IP20	<b>71-6652-00-00</b>	<b>71-6142-00-00</b>	<b>71-6653-00-00</b>	<b>71-3542-00-00</b>
	PHASE CUT 240V IP20	<b>71-A297-00-00</b>	<b>71-4898-00-00</b>	<b>71-A299-00-00</b>	-
	1-10V PUSH IP20	<b>71-7710-00-00</b>	<b>71-7710-00-00</b>	<b>71-4708-00-00</b>	<b>71-4708-00-00</b>
	DALI2 IP20	<b>71-B407-00-00</b>	<b>71-B407-00-00</b>	<b>71-A192-00-00</b>	<b>71-A303-00-00</b>
	DALI D4i DALI2 IP20	-	-	<b>71-7737-00-00</b>	-
	CASAMBI IP20	<b>71-A260-00-00</b>	<b>71-A260-00-00</b>	<b>71-A260-00-00</b>	<b>71-A260-00-00</b>

## Accesorios ópticos

### Accessórios óticos

	Difusor elíptico (1u.) Difusor elíptico (1u.)	-	-	<b>71-5646-60-00</b>	<b>71-5646-60-00</b>
	Difusor cuadrado (1u.) Difusor quadrado (1u.)	-	-	<b>71-5647-60-00</b>	<b>71-5647-60-00</b>
	Difuminador de halo (5u.) Difusor opalino (5u.)	<b>71-6099-00-00</b>	<b>71-6099-00-00</b>	-	-
	Panel de abeja (1u.) Painel de abelha (1u.)	-	-	<b>71-5201-60-00</b>	<b>71-5201-60-00</b>

Sia Lens incorpora un sistema de lentes que permiten crear distintos efectos de luz  
 Sia Lens incorpora um sistema de lentes que permite criar diferentes efeitos de luz

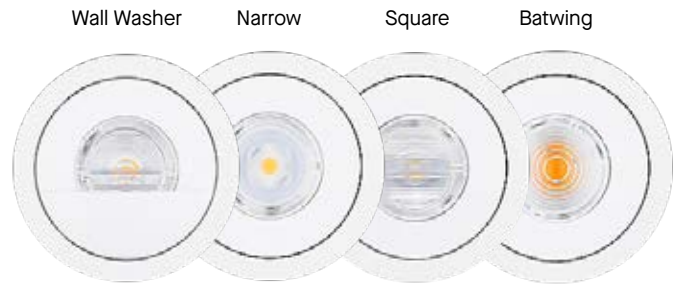

Wall Washer

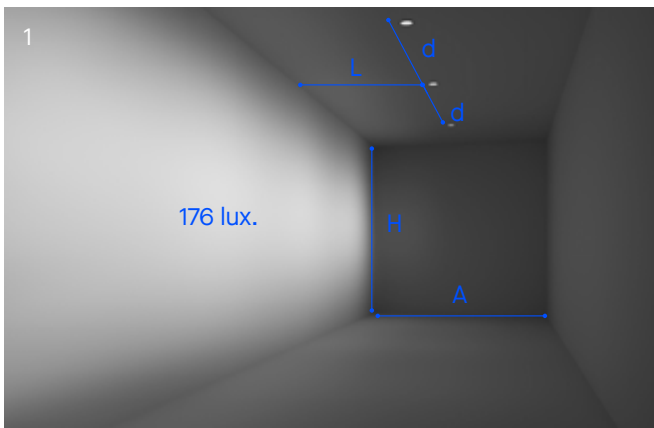

A= 3 mts. H= 4 mts. L= 1.45 mts. d= 1.40 mts. U= 0.60

Narrow

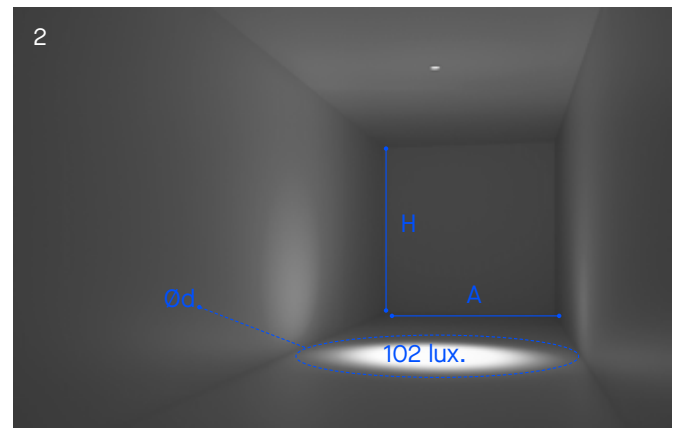

A= 3 mts. H= 3 mts. d= 3.3 mts. U= 0.63 mts.

Square

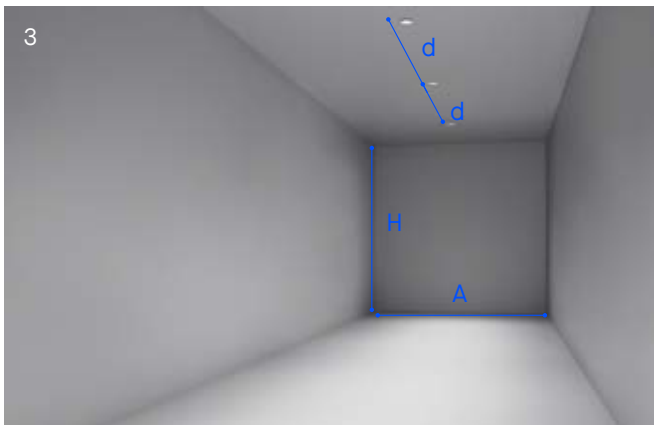

A= 3 mts. H= 3 mts. d= 3.3 mts. U= 0.60

Batwing

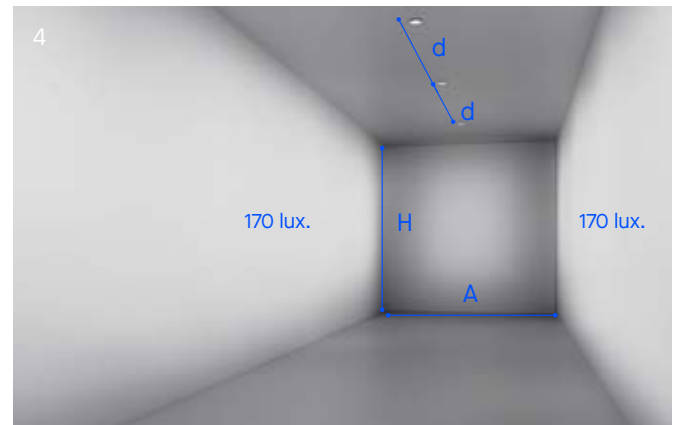

A= 3 mts. H= 3 mts. d= 2 mts. U= 0.69

① **Wall Washer**

Bañado perfecto en pared.  
 Washlight perfeito na parede.

② **Narrow**

Efecto de acento con una luz controlada, nítida y sin residuos.  
 Efeito de realce com uma luz controlada, nítida e sem resíduos.

③ **Square**

Proyección de haz de luz cuadrada.  
 Projeção do feixe de luz quadrado.

④ **Batwing**

Emisión bilateral para pasillos, consigue un efecto uniforme de techo al suelo, acentuando el efecto de luz uniforme en las paredes.  
 Emissão bilateral para corredores, tem um efeito uniforme do teto ao chão, acentuando o efeito da luz uniforme nas paredes.

BODY MAT	DIF MAT	50000h	2
AL	PMMA	L80 B20	MacAdam

Sia Lens  
Batwing

IP	WELL		
54			

Ejemplo de código / Exemplo de código: **AH24-12V8AZOUWR**

Model		W	K / Cri / Real lm	Optics	Source	Finishes
<b>AH24 -</b> Batwing / Con Marco Batwing / Com Aro 0-16 mm  100	 ● ○ WN WR	12 12W	<b>V8</b> 2700K / CRI80 / 1444 lm	<b>AZ</b> Batwing	<b>OU</b> ON-OFF 100-240V	   
			<b>W8</b> 3000K / CRI80 / 1444 lm		<b>DS</b> DALI-2 100-240V	
			<b>W9</b> 3000K / CRI90 / 1244 lm		<b>BB</b> 36V/max.350mA	
			<b>X8</b> 4000K / CRI80 / 1444 lm			
<b>AH25 -</b> Batwing / Sin Marco Batwing / Sem Aro 0-16 mm  96	 ○ ● WP WQ	17 17.7W	<b>V8</b> 2700K / CRI80 / 1886 lm	<b>AZ</b> Batwing	<b>OU</b> ON-OFF 100-240V	   
			<b>W8</b> 3000K / CRI80 / 1886 lm		<b>DS</b> DALI-2 100-240V	
			<b>W9</b> 3000K / CRI90 / 1624 lm		<b>BB</b> 36V/max.500mA	
			<b>X8</b> 4000K / CRI80 / 1886 lm			

Sia Lens  
Narrow

IP	WELL		
54			

Ejemplo de código / Exemplo de código: **AH28-12V8AZOUWR**

Model		W	K / Cri / Real lm	Optics	Source	Finishes
<b>AH28 -</b> Narrow / Con Marco Narrow / Com Aro 0-16 mm  100	 ● ○ WN WR	12 12W	<b>V8</b> 2700K / CRI80 / 1347 lm	<b>AZ</b> Narrow	<b>OU</b> ON-OFF 100-240V	   
			<b>W8</b> 3000K / CRI80 / 1347 lm		<b>DS</b> DALI-2 100-240V	
			<b>W9</b> 3000K / CRI90 / 1159 lm		<b>BB</b> 36V/max.350mA	
			<b>X8</b> 4000K / CRI80 / 1347 lm			
<b>AH29 -</b> Narrow / Sin Marco Narrow / Sem Aro 0-16 mm  96	 ○ ● WP WQ	17 17.7W	<b>V8</b> 2700K / CRI80 / 1757 lm	<b>AZ</b> Narrow	<b>OU</b> ON-OFF 100-240V	   
			<b>W8</b> 3000K / CRI80 / 1757 lm		<b>DS</b> DALI-2 100-240V	
			<b>W9</b> 3000K / CRI90 / 1513 lm		<b>BB</b> 36V/max.500mA	
			<b>X8</b> 4000K / CRI80 / 1757 lm			

## Sia Lens Square



Ejemplo de código / Exemplo de código: **AH26-12V8AZOUWR**

Model	W	K / Cri / Real lm	Optics	Source	Finishes
<b>AH26 -</b> Square / Con Marco Square / Com Aro 0-16 mm 100	 51 Ø115	<b>V8</b> 2700K / CRI80 / 1392 lm	<b>AZ</b> Square	<b>OU</b> ON-OFF 100-240V	   
		<b>W8</b> 3000K / CRI80 / 1392 lm		<b>DS</b> DALI-2 100-240V	
		<b>W9</b> 3000K / CRI90 / 1198 lm		<b>BB</b> (SC) 36V/max.350mA	
		<b>X8</b> 4000K / CRI80 / 1392 lm			
<b>AH27 -</b> Square / Sin Marco Square / Sem Aro 0-16 mm 96	 51 Ø96	<b>V8</b> 2700K / CRI80 / 1826 lm	<b>AZ</b> Square	<b>OU</b> ON-OFF 100-240V	
		<b>W8</b> 3000K / CRI80 / 1826 lm		<b>DS</b> DALI-2 100-240V	
		<b>W9</b> 3000K / CRI90 / 1572 lm		<b>BB</b> (SC) 36V/max.500mA	
		<b>X8</b> 4000K / CRI80 / 1826 lm			

## Sia Lens Wallwasher



Ejemplo de código / Exemplo de código: **AH22-12V8AZOUWR**

Model	W	K / Cri / Real lm	Optics	Source	Finishes
<b>AH22 -</b> Wall Washer / Con Marco Wall Washer / Com Aro 0-16 mm 100	 65 Ø115	<b>V8</b> 2700K / CRI80 / 1297 lm	<b>AZ</b> Wall Washer	<b>OU</b> ON-OFF 100-240V	   
		<b>W8</b> 3000K / CRI80 / 1297 lm		<b>DS</b> DALI-2 100-240V	
		<b>W9</b> 3000K / CRI90 / 1097 lm		<b>BB</b> (SC) 36V/max.350mA	
		<b>X8</b> 4000K / CRI80 / 1297 lm			
<b>AH23 -</b> Wall Washer / Sin Marco Wall Washer / Sem Aro 0-16 mm 96	 65 Ø96	<b>V8</b> 2700K / CRI80 / 1659 lm	<b>AZ</b> Wall Washer	<b>OU</b> ON-OFF 100-240V	
		<b>W8</b> 3000K / CRI80 / 1659 lm		<b>DS</b> DALI-2 100-240V	
		<b>W9</b> 3000K / CRI90 / 1459 lm		<b>BB</b> (SC) 36V/max.500mA	
		<b>X8</b> 4000K / CRI80 / 1659 lm			

**Sia Lens  
Batwing 12W**



**Sia Lens  
Batwing 17W**



**Sia Lens  
Narrow 12W**



**Sia Lens  
Narrow 17W**



**Drivers  
Driver**

P. 1166



ON-OFF  
IP20

**71-6652-00-00**

**71-6142-00-00**

**71-6652-00-00**

**71-6142-00-00**



PHASE CUT 240V  
IP20

**71-A297-00-00**

**71-4898-00-00**

**71-A297-00-00**

**71-4898-00-00**



1-10V  
PUSH  
IP20

**71-7710-00-00**

**71-7710-00-00**

**71-7710-00-00**

**71-7710-00-00**



DALI2  
IP20

**71-B407-00-00**

**71-B407-00-00**

**71-B407-00-00**

**71-B407-00-00**



CASAMBI  
IP20

**71-A260-00-00**

**71-A260-00-00**

**71-A260-00-00**

**71-A260-00-00**

Sia Lens  
Square 12W



Sia Lens  
Square 17W



Sia Lens  
Wall Washer 12W







Sia Lens  
Wall Washer 17W



**Drivers**  
Driver

P. 1166

	ON-OFF IP20	<b>71-6652-00-00</b>	<b>71-6142-00-00</b>	<b>71-6652-00-00</b>	<b>71-6142-00-00</b>
	PHASE CUT 240V IP20	<b>71-A297-00-00</b>	<b>71-4898-00-00</b>	<b>71-A297-00-00</b>	<b>71-4898-00-00</b>
	1-10V PUSH IP20	<b>71-7710-00-00</b>	<b>71-7710-00-00</b>	<b>71-7710-00-00</b>	<b>71-7710-00-00</b>
	DALI2 IP20	<b>71-B407-00-00</b>	<b>71-B407-00-00</b>	<b>71-B407-00-00</b>	<b>71-B407-00-00</b>
	CASAMBI IP20	<b>71-A260-00-00</b>	<b>71-A260-00-00</b>	<b>71-A260-00-00</b>	<b>71-A260-00-00</b>



# Biwa

Designed by BMLD 2020

## Diseñado para una iluminación de acento Concebida para uma iluminação de realce

De la colaboración entre BMLD y LedsC4 nace Biwa, un downlight compacto pensado para la iluminación de acento. Biwa permite crear efectos dramáticos y jugar con los claro-oscuros de la escena. Proyecta un haz de luz limpio, nítido y sin residuos y ofrece muchas posibilidades de ajuste para adaptarse con precisión al espacio.

Da colaboração entre BMLD e LedsC4 nasce Biwa, um Downlight compacto concebido para a iluminação de realce. Biwa permite criar efeitos dramáticos e brincar com os claro-escuro da cena. Projeta um feixe de luz limpo, nítido e sem resíduos e oferece muitas possibilidades de ajuste para se adaptar com precisão ao espaço.



## Tamaño reducido Tamanho reduzido



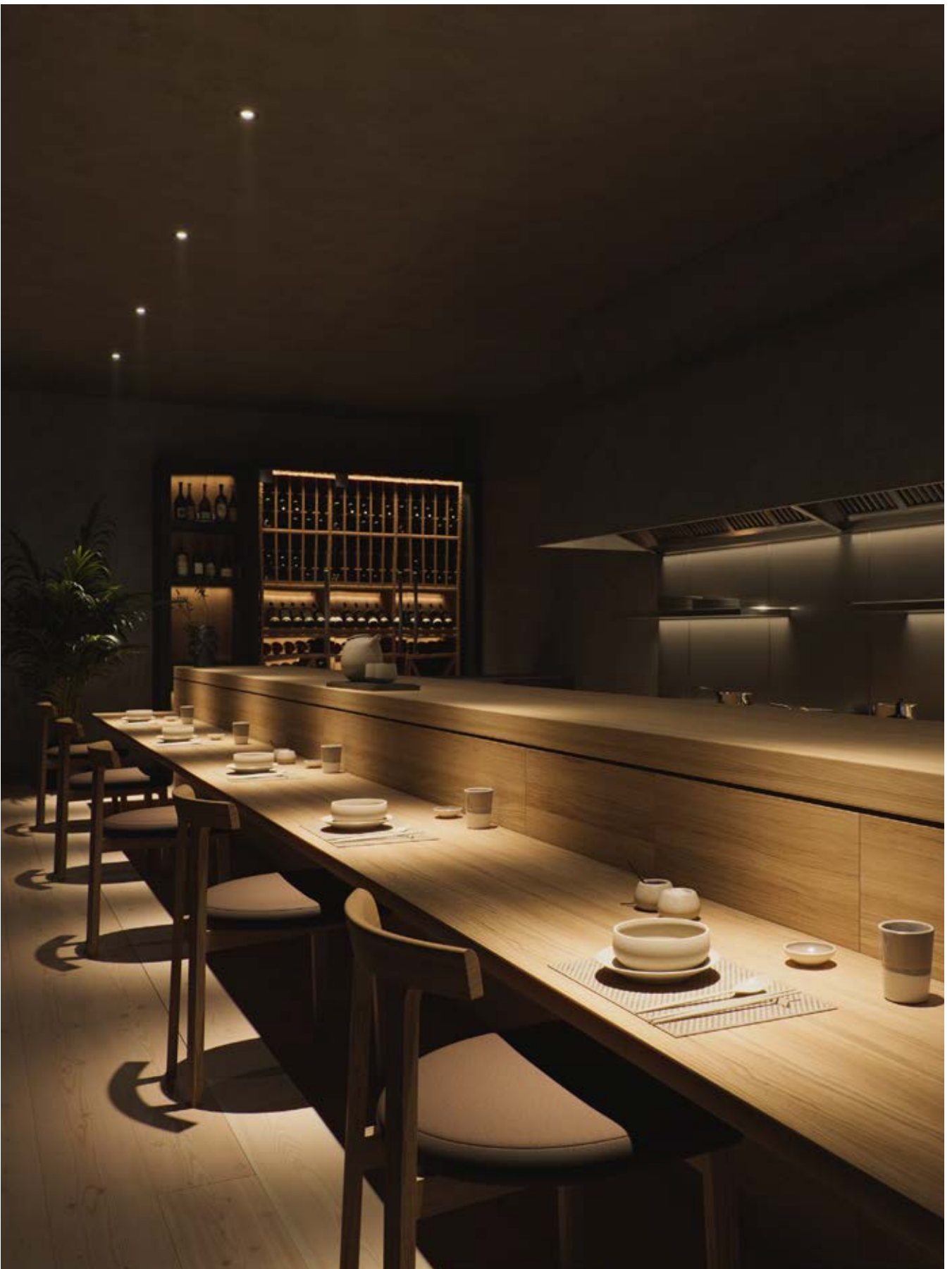

Biwa permite dramatizar cualquier ambiente  
Biwa permite dramatizar qualquer ambiente

# Biwa

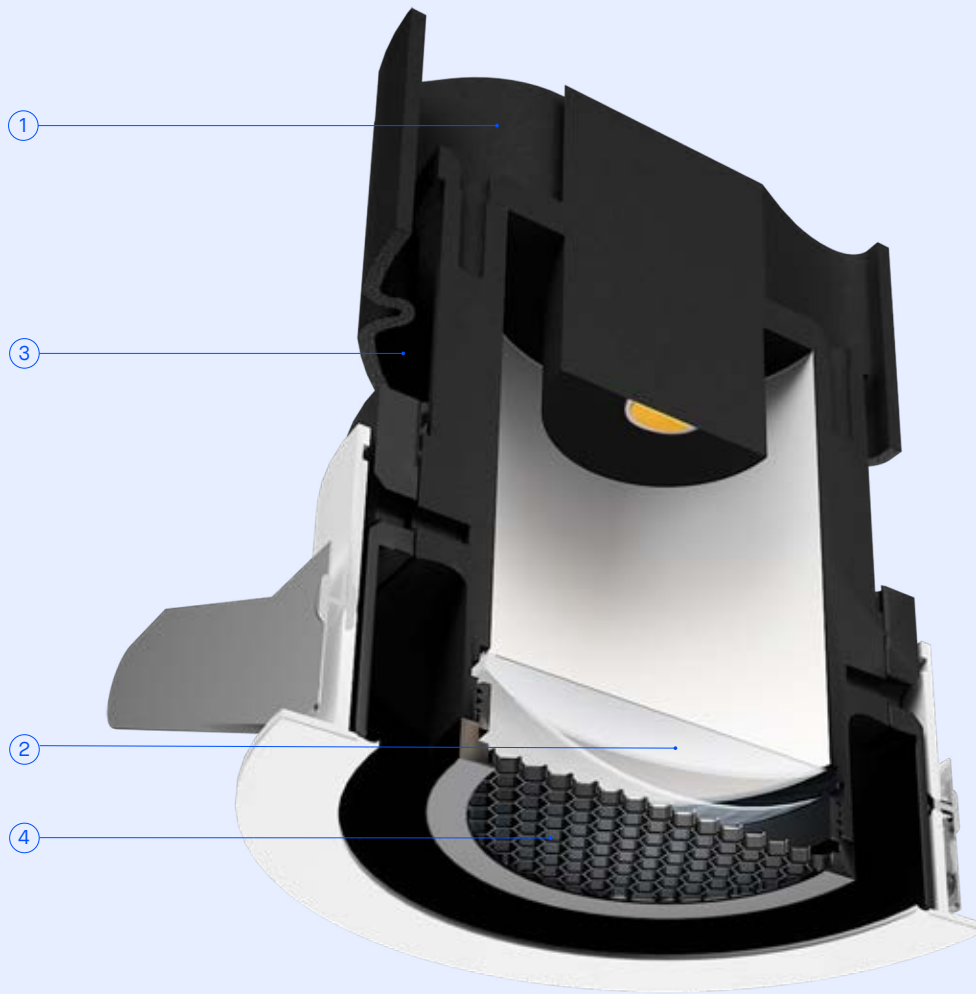

- ① Disipador diseñado por LedsC4 altamente eficiente  
Dissipador projetado pela LedsC4 altamente eficiente
- ② Ótimo sistema de lentes  
Ótimo sistema de lentes
- ③ Ajuste de inclinación hasta 28°  
Ajuste de inclinação hasta 28°
- ④ Amplitud de accesorios:  
Amplitude de acessórios:



BODY MAT
AL

DIF MAT
AL



50000h
L80 B20

2
MacAdam

IP
20

UGR
<10



28°
-----



14

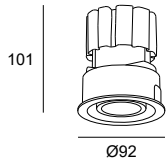

## LED

K	CRI	W Total	Real Lm	Optics	Code	
3000	90	20	206	8°	90-8205	- 14 - OU ON-OFF 100-240V
3000	90	20	255	15°	90-8206	- 14 - DS DALI-2 220-240V

85 10-25 mm

## Controladores

P. 1166



CASAMBI  
IP20

71-5961-00-00

## Accesorios ópticos

### Accessórios óticos



Panel de abeja  
Favo de abelha

Included



Difusor elíptico (1u.)  
Difusor elíptico (1u.)

71-8226-00-00



Difusor cuadrado (1u.)  
Difusor quadrado (1u.)

71-8224-00-00



Filtro neutro  
Filtro neutro

71-8228-00-00



Filtro cálido  
Filtro quente

71-8227-00-00



Con una intensidad de hasta 14000 cd permite acentuar cualquier objeto desde la distancia  
Com uma intensidade de até 14000 cd permite acentuar qualquer objeto à distância

# Veo

Designed by LedsC4 Architectural



Downlight de diseño limpio y funcional para espacios de diversos usos, que se adapta a distintos diámetros de empotrar, por lo que facilita su instalación en techos donde existía un hueco previo.

Downlight básico, com um design limpo e funcional para espaços de diversas utilizações, que se adapta a diferentes diâmetros de encastrar, facilitando a instalação em tetos onde existia um furo prévio.

Solución efectiva  
para cualquier tipo de  
ambiente

Solução eficaz  
para qualquer tipo  
de ambiente

## Diferentes medidas Medidas diferentes



Small



Medium



Big





Bisel extra que permite la instalación en agujeros de empotrar con medidas diferentes a las standard  
 Bisel extra que permite a instalação em furos de encastrar com medidas diferentes do standard

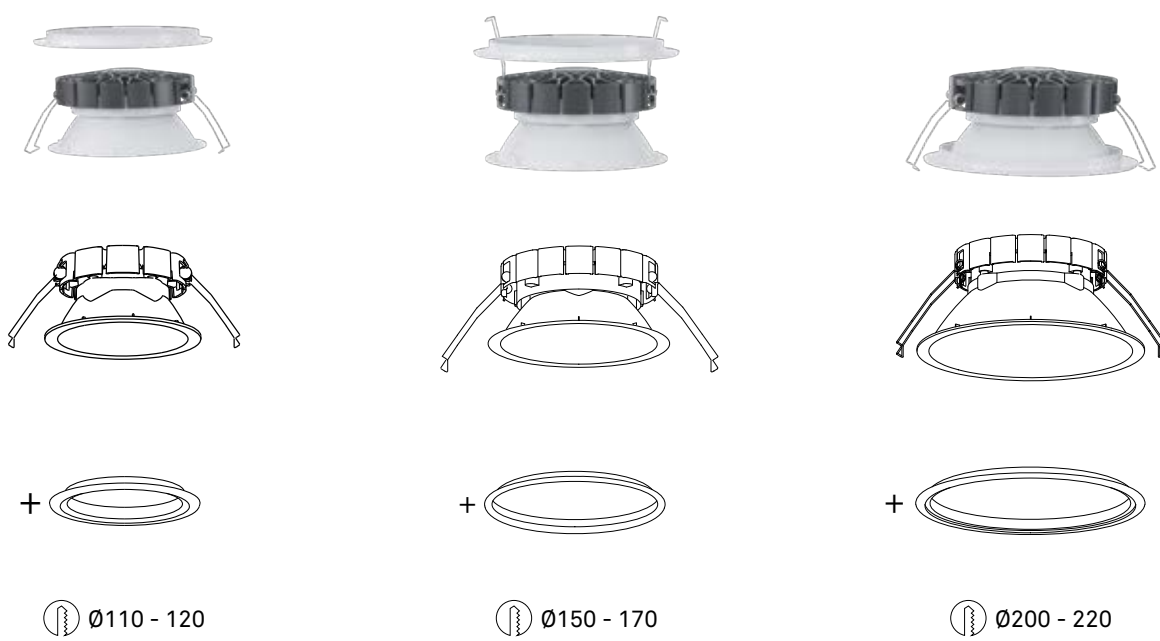

Ø 110- 130



Ø 161-180



Ø 210-230

Reducido tamaño de instalación  
Tamanho da instalação reduzido

Diseño que permite disipar el calor de forma efectiva aunque la pieza tenga poca altura  
Design que permite que o calor seja dissipado de forma eficaz, mesmo quando a peça tem pouca altura

Fácil mantenimiento gracias a un tratamiento especial anti-ralladas y anti-polvo  
Manutenção fácil graças a um tratamento especial antirriscos e antipó



# Veo

BODY MAT	DIF MAT		50000h	3
PC,AL	PC		L80 B20	MacAdam

## Veo 130mm

IP	LOW			
54	FLICKER			

14



62



Ø110



Ø130

100 0-25 mm

LED									
K	CRI	W Total	Real Lm	Optics	Code				
3000	82	10	1123	67	90-A032 - 14	00	ON-OFF	220-240V	
						DS	DALI-2	220-240V	
4000	82	10	1156	67	90-A033 - 14	00	ON-OFF	220-240V	
						DS	DALI-2	220-240V	



Veo emergency  
P.1041

**Veo 180mm**

IP	UGR	LOW			
54	<22	FLICKER			

14

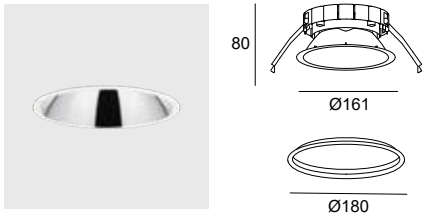

150-170 0-25 mm

LED							
K	CRI	W Total	Real Lm	Optics	Code		
3000	82	13.5	1434	66	<b>90-A034 - 14</b>	<b>OO</b>	ON-OFF 220-240V
						<b>DS</b>	DALI-2 220-240V
4000	82	13.5	1477	66	<b>90-A035 - 14</b>	<b>OO</b>	ON-OFF 220-240V
						<b>DS</b>	DALI-2 220-240V



**Veo emergency**  
 P.1041

**Veo 230mm**

IP	UGR	LOW			
54	<19	FLICKER			

14

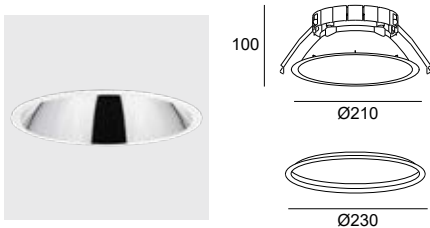

200-220 0-25 mm

LED							
K	CRI	W Total	Real Lm	Optics	Code		
3000	82	19.1	1960	74	<b>90-A036 - 14</b>	<b>OO</b>	ON-OFF 220-240V
						<b>DS</b>	DALI-2 220-240V
4000	82	19.1	2019	74	<b>90-A037 - 14</b>	<b>OO</b>	ON-OFF 220-240V
						<b>DS</b>	DALI-2 220-240V



**Veo emergency**  
 P.1041

**Veo 130mm**

**Veo 180mm**

**Veo 230mm**



**Controladores**  
**Controladores**

P. 1166



CASAMBI  
 IP20

**71-5961-00-00**

**71-5961-00-00**

**71-5961-00-00**

**Accesorios de fijación**  
**Acessórios de fixação**



Anillo extra para adaptar a diferentes diámetros  
 Bisel extra para adaptar a diferentes diámetros

Included

Included

Included



Downlight de tamaño compacto que ofrece una iluminación general y uniforme

Downlight de tamanho compacto que oferece uma iluminação geral e uniforme

BODY MAT	DIF MAT	50000h	3
AL	PMMA	L80 B20	MacAdam

## Vol Ø135 mm

IP	IK				
54	08				

14

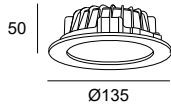

LED						
K	CRI	W Total	Real Lm	Code		
3000	80	10.7	847	<b>90-4880 - 14 - M3</b>	ON-OFF	100-240V
4000	80	10.7	888	<b>90-4881 - 14 - M3</b>	ON-OFF	100-240V

117 0-25 mm

## Vol Ø135 mm Not Included

IP	IK			
54	08			

14

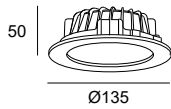

LED						max.700mA 12V
K	CRI	W	Real Lm	Code		
3000	80	8.4	847	<b>90-3925 - 14 - M3</b>		
4000	80	8.4	888	<b>90-3926 - 14 - M3</b>		

117 0-25 mm

## Vol Ø205 mm

IP	IK				
54	08				

14

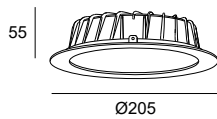

LED						
K	CRI	W Total	Real Lm	Code		
3000	80	18.1	1934	<b>90-2899 - 14 - M3</b>	ON-OFF	100-240V
4000	80	18.1	1989	<b>90-4883 - 14 - M3</b>	ON-OFF	100-240V

180 0-25 mm

## Vol Ø205 mm Not Included

IP	IK			
54	08			

14

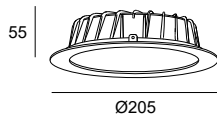

LED						max.700mA 24V
K	CRI	W	Real Lm	Code		
3000	80	16.8	1934	<b>90-3927 - 14 - M3</b>		
4000	80	16.8	1989	<b>90-3928 - 14 - M3</b>		

180 0-25 mm

**Vol Ø254 mm**

IP	IK			
54	08			

14



57

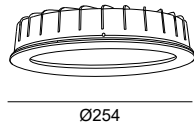

LED						
K	CRI	W Total	Real Lm	Code		
3000	80	28.4	3012	<b>90-4885 - 14 - M3</b>	ON-OFF	100-240V
4000	80	28.4	3109	<b>90-4886 - 14 - M3</b>	ON-OFF	100-240V

230 0-25 mm

**Vol Ø254 mm Not Included**

IP	IK			
54	08			

14



57

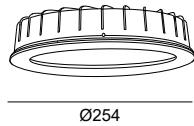

LED					
K	CRI	W	Real Lm	Code	
3000	80	25.4	3012	<b>90-3929 - 14 - M3</b>	max.700mA 36V
4000	80	25.4	3109	<b>90-3930 - 14 - M3</b>	

230 0-25 mm

Vol Ø135 mm

Vol Ø205 mm

Vol Ø254 mm



**Drivers**  
Driver

P. 1166

	ON-OFF IP20	<b>71-B232-00-00</b>	<b>71-6658-00-00</b>	<b>71-6653-00-00</b>
		Min.1 - Max.1	Min.1 - Max.1	Min.1 - Max.1
	PHASE CUT 240V IP20	<b>71-7663-00-00</b>	<b>71-A299-00-00</b>	<b>71-A299-00-00</b>
		Min.1 - Max.1	Min.1 - Max.1	Min.1 - Max.1
	1-10V PUSH IP20	<b>71-7710-00-00</b>	<b>71-7710-00-00</b>	<b>71-4708-00-00</b>
		Min.1 - Max.2	Min.1 - Max.1	Min.1 - Max.1
	DALI2 IP20	<b>71-A190-00-00</b>	<b>71-A192-00-00</b>	<b>71-A192-00-00</b>
		Min.1 - Max.1	Min.1 - Max.1	Min.1 - Max.1
	CASAMBI IP20	<b>71-A261-00-00</b>	<b>71-A261-00-00</b>	<b>71-A260-00-00</b>
		Min.1 - Max.3	Min.1 - Max.1	Min.1 - Max.1



# Play

Designed by LedsC4 Architectural



+ Play





Colección de downlights con infinitas posibilidades y una excepcional versatilidad que le permite adecuarse fácilmente a cualquier tipo de espacios. Tiene una capacidad de configuración con más de 40.000 opciones

Coleção de downlights com possibilidades infinitas e uma versatilidade excepcional que lhe permite adaptar-se facilmente a qualquer tipo de espaço. Tem uma capacidade de configuração com mais de 40.000 opções

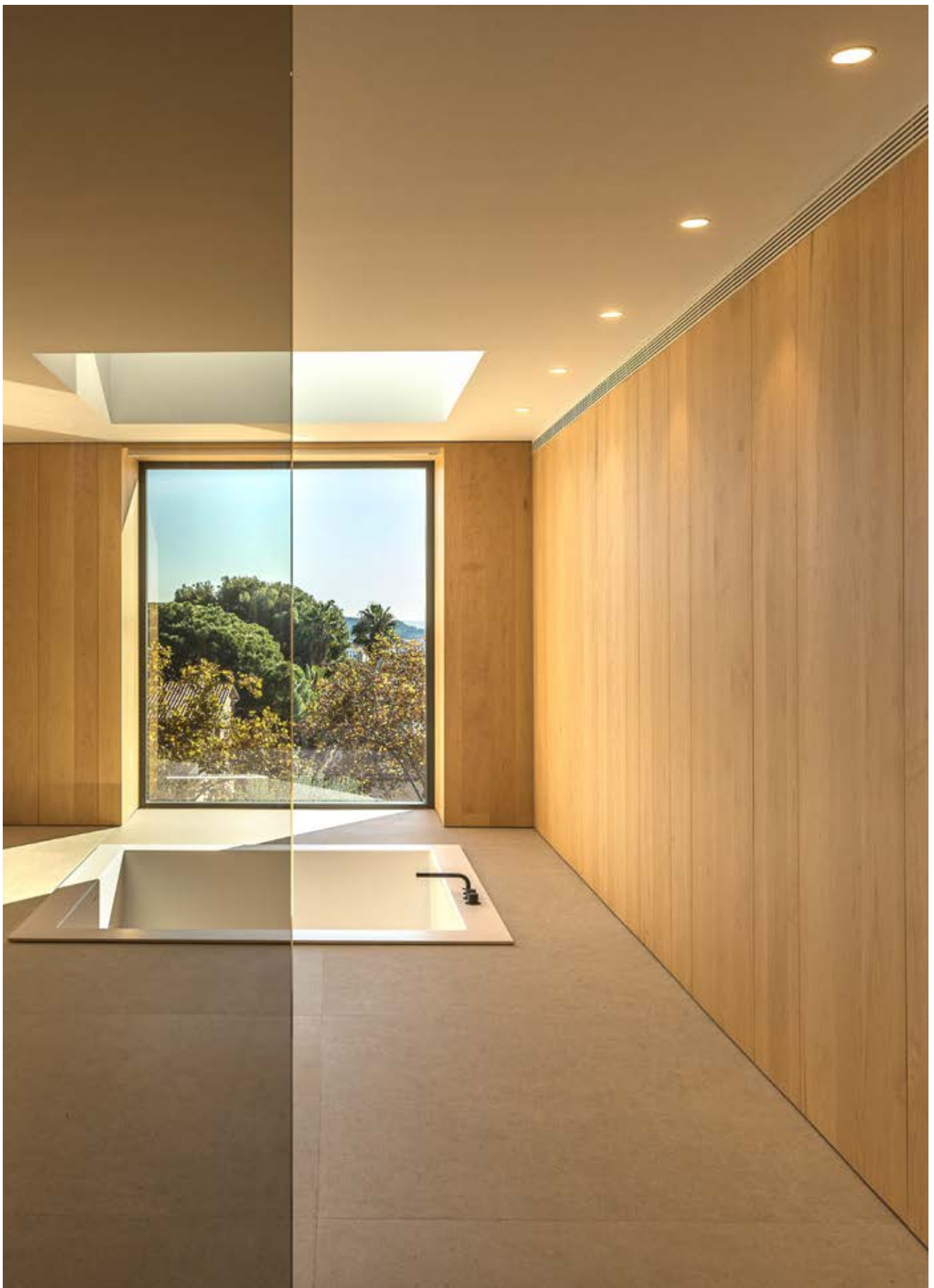



INDOOR

DOWNLIGHTS

**Play Deco Pendant y High Visual Confort Adjustable**, con características técnicas y decorativas ajustadas a cada necesidad.  
**Play Deco Pendant e High Visual Confort Adjustable**, com características técnicas e decorativas ajustadas a cada necessidade.



Nueva óptica de 8°  
Nova ótica de 8°



① Distintos módulos según tamaño y necesidad:  
Distintos módulos segundo o tamanho e necessidade:

Play Mini:  
1,5 W  
3W

Play Standard:  
7W  
13W  
18W

② Posibilidad de difentes lentes con distintas aperturas:  
Possibilidade de diferentes lentes com diversas aberturas:

Spot (6°-20°)  
Medium (20°-40°)  
Flood (40°-50°)

③ Gran cantidad de marcos disponibles, en combinación con los distintos módulos:  
Grande quantidade de aros disponíveis, em combinação com os diferentes módulos:

Flat  
Deep  
High visual Comfort  
IP65  
IP65 Glass  
Pinhole  
Soft  
Snoot  
Raw Racy Gold  
Raw Walnut  
Raw Oak  
Raw Alabastre  
Raw Concrete  
Deco Symmetrical  
Deco Asymmetrical  
Deco Double  
Deco Surface

Accesorios opcionales:  
Acessórios opcionais:

Panel de abeja  
Painel de abelha  
Confort visual  
Difusor elíptico  
Difusor elíptico  
Difusor cuadrado  
Difusor quadrado  
Difusor opal  
Difusor opalino  
Screen



## Accesorios que modelan la luz

## Acessórios que modelam a luz

Los accesorios disponibles moldean la luz añadiendo más opciones al proyecto lumínico a las ya disponibles.

Os acessórios disponíveis moldam a luz adicionando mais opções ao projeto lumínico às já disponíveis.

- 1 Panel de abeja  
Painel de abelha
- 2 Difusor elíptico  
Difusor elíptico
- 3 Difusor cuadrado  
Difusor quadrado
- 4 Difusor opal  
Difusor opalino
- 5 Screen
- 6 Visual Comfort

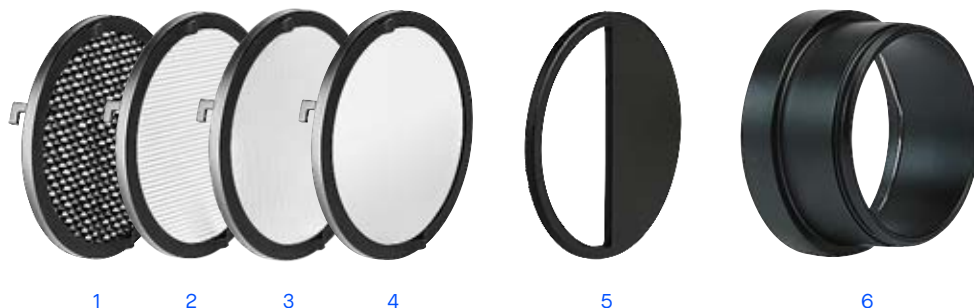

## Opciones Smart

## Opções Smart



Gracias a las funcionalidades Smart, Play puede configurarse para generar atmósferas lumínicas que doten de flexibilidad al espacio, para ahorrar energía por control de ocupación o entrada de luz natural, gestionar el espacio o realizar un mantenimiento preventivo, entre otros.

Graças às funcionalidades Smart, Play pode ser configurado para gerar atmosferas lumínicas que proporcionem flexibilidade ao espaço, para poupar energia controlando a ocupação ou a entrada de luz natural, gerir o espaço ou realizar uma manutenção preventiva, entre outros.



Función de programación horaria.  
Função de programação horária.

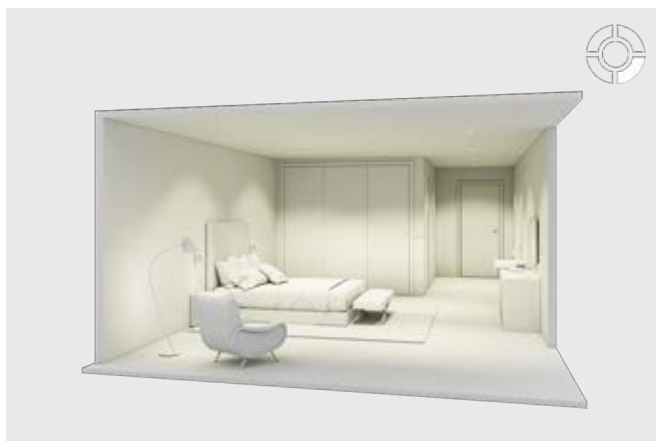





INDOOR

DOWNLIGHTS



**Play High Visual Confort** negra en Proyecto Oficinas Manusa Barcelona. Fotografía: Jordi Anguera.  
**Play High Visual Confort** preto no Projeto Manusa Barcelona Offices. Fotografía: Jordi Anguera.

## Materiales nobles y detalles cuidados Materiais nobres e detalhes cuidados

La colección incluye materiales y acabados trabajados al detalle con el cuidado de las manos expertas de nuestros técnicos de fabricación.

A coleção inclui materiais e acabamentos trabalhados ao pormenor com o cuidado das mãos especializadas dos nossos técnicos de fabricação.



# Producto sostenible Produto sustentável



Play cuenta con la Declaración Ambiental EPD, certificación que registra el impacto ambiental del producto a lo largo de su vida útil.

Play possui a Declaração Ambiental EPD, uma certificação que registra o impacto ambiental do produto ao longo da sua vida útil.



## Compromiso ODS (Objetivos de Desarrollo Sostenible) Compromisso ODS (Objetivos de Desenvolvimento Sustentável)



### **Eficiencia Energética** Eficiência energética

La composición de la pieza favorece la disipación térmica y permite ajustar el consumo regulando la intensidad luminosa.

A composição da peça favorece a dissipação térmica e permite ajustar o consumo regulando a intensidade luminosa.

### **Material reciclable** Material reciclável

Utilización de productos reciclables y/o procedentes de fuentes reciclables.

Utilização de produtos recicláveis e/ou procedentes de fontes recicláveis.

### **Diseño sostenible** Design sustentável

Fácil recambio del módulo LED y mecanismo de control para aumentar la vida útil del producto.

Troca fácil do módulo LED e mecanismo de controlo para aumentar a vida útil do produto.

### **Segregación de residuos** Segregação de resíduos

Play permite el desmontaje de componentes para facilitar la gestión de residuos.

Play permite a desmontagem de componentes para facilitar a gestão de resíduos.

# Modules





1,5W

3,2W



## Marcos / Molduras

[F] Fixed [A] Adjustable

Flat	High Visual Confort	IP65	Pinhole	Soft	Snoot	Raw Racy Gold	Raw
P. 210	P. 213	P. 214	P. 216	P. 218	P. 219	P. 220	P. 221
<b>AG33</b> [F] Trim	<b>AG36 / AG41</b> [F] Trim/Trimless	<b>AG37</b> [F] Trim	<b>AG61</b> [F] Trim	<b>AG63</b> [F] Trim		<b>AG66</b> [F] Trim	<b>AG67</b> [F] Trim
							
Ø 45 mm	Ø 45/36 mm	Ø 50 mm	Ø 65 mm	Ø 65 mm		Ø 65 mm	Ø 65 mm
○ ● 14 60	○ ● 14 60	○ ● 14 60	○ ● 14 60	○ ● 14 60		○ ● EP	○ ● ● 55 EN EO
<b>AG34</b> [A] Trim			<b>AG62</b> [A] Trim	<b>AG64</b> [A] Trim	<b>AG65</b> [A] Trim		
							
Ø 52 mm			Ø 65 mm	Ø 65 mm	Ø 70 mm		
○ ● ● 14 60 AF			○ ● 14 60	○ ● 14 60	○ ● 14 60		
<b>AG38</b> [F] Trim							
							
Ø 45 mm							
○ ● 14 60							
<b>AG39</b> [A] Trim							
							
Ø 52 mm							
○ ● 14 60							

### Acabados / Acabamentos

- 14 Blanco / Branco
- 60 Negro / Preto
- 21 Cromo / Cromado
- AF Aluminio satinado / Aluminio satinado
- DC Cemento / Cimento
- EP Oro intenso / Oro intenso
- EN Madera nogal / Madeira nogueira
- 55 Alabastro / Alabastro
- EO Madera roble / Madeira carvalho

6,4W

11,9W





17,7W

GU10



## Marcos / Molduras

[F] Fixed [A] Adjustable

Flat	Deep	High Visual Confort	IP65	IP65 Glass	Pinhole	Soft	Snoot
P. 212	P. 214	P. 213	P. 214	P. 215	P. 217	P. 218	P. 219
<b>AG11</b> [F] Trim	<b>AG15</b> [F] Trim	<b>AG13</b> [F] Trim	<b>AG16</b> [F] Trim	<b>AG43</b> [F] Trim	<b>AG45</b> [F] Trim		
							
Ø 65 mm ○ ● 14 60	Ø 65 mm ○ ● 14 60	Ø 90 mm ○ ● 14 60	Ø 93 mm ○ ● ◐ 14 60 21	Ø 92 mm ○ 14	Ø 88 mm ○ 14		
<b>AG12</b> [A] Trim	<b>AG17</b> [A] Trimless	<b>AG14</b> [A] Trim			<b>AG47</b> [A] Trim	<b>AG52 / AG53</b> [A] Trim/Trimless	<b>AG56 / AG57</b> [A] Trim/Trimless
							
Ø 78 mm ○ ● ◐ AF 14 60 14	Ø 75 mm ○ ● 14 60	Ø 100 mm ○ ● 14 60			Ø 88 mm ○ 14	Ø 95/95 mm ○ ● 14 60	Ø 95/86 mm ○ ● 14 60
<b>AG19</b> [F] Trim			<b>AG22</b> [F] Trim	<b>AG44</b> [F] Trim	<b>AG46</b> [F] Trim		
							
Ø 65 mm ○ ● 14 60			Ø 93 mm ○ ● 14 60	Ø 92 mm ○ 14	Ø 85 mm ○ 14		
<b>AG21</b> [A] Trim					<b>AG48</b> [A] Trim	<b>AG55</b> [A] Trim	
							
Ø 78 mm ○ ● 14 60					Ø 85 mm ○ 14	Ø 95 mm ○ ● 14 60	

# Módulos / Modulos

6,4W      11,9W      17,7W      GU10



# Marcos / Molduras

F Fixed A Adjustable

## Raw Racy Gold

P. 220

**AG58**

F Trim



Ø 110 mm



## Raw

P. 221

**AG59**

F Trim



Ø 110 mm



## Deco Symmetrical

P. 222

**AG23 / AG24**

F Trim/Trimless



Ø 90/74 mm



## Deco Asymmetrical

P. 223

**AG25 / AG26**

F Trim/Trimless



Ø 90/74 mm



## Deco Double

P. 224

**AG42**

A Trim



193 × 103 mm



## Deco Surface

P. 311

**AG32**

F Surface



Ø 72.5 mm



## AG27 / AG28

F Trim/Trimless

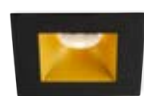

∅ 110/74 mm



## AG29 / AG31

F Trim/Trimless

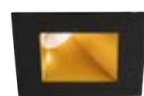

∅ 110/74 mm



## AG68

F Pendant



Ø 72.5 mm



## AG71

A 3-Phase Track



Ø 72.5 mm



## Acabados / Acabamentos

- 14 Blanco / Branco
- 60 Negro / Preto
- WR Blanco/Blanco / Branco/Branco
- WG Blanco/Oro / Branco/Ouro
- WH Negro/Blanco / Preto/Branco
- WI Oro/Blanco / Ouro/Branco
- WJ Oro/Oro /Ouro/Ouro
- WK Oro/Negro /Ouro/Preto
- WL Negro/Blanco /Preto/Branco
- WM Negro/Oro / Preto/Ouro
- WP Sin marco/Blanco / Trimless/Branco
- WS Sin marco/Oro / Trimless/Ouro
- WQ Sin marco/Negro / Trimless/Preto
- WN Negro/Negro / Preto/Preto
- 23 Oro / Ouro





Opciones de configuración infinitas de forma fácil y rápida gracias nuestro configurador online.

Opções de configuração infinitas de uma forma rápida e fácil, graças ao nosso configurador online.



**1** Seleccionar módulos  
Seleccionar módulos



**2** Seleccionar temperatura de color,  
ángulo y drivers  
Seleccionar temperatura de cor,  
ângulo e condutores

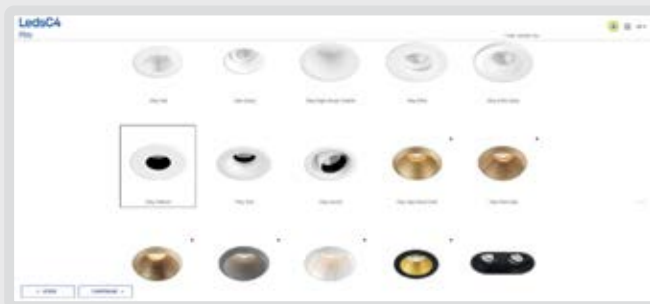

**3** Seleccionar marcos  
Seleccionar molduras



**4** Seleccionar accesorios  
Seleccionar acessórios

**5** Descarga de documentación  
Descarregar de documentação

# Play Best Sellers

## Play Flat Round Fixed



68 IP65

W LED	K	CRI	Optics	Source	Finishes
6.4W	3000K	90	28°	ON-OFF DALI-2	<a href="#">AG11-P7W9M2OUXX</a> 14 ○ <a href="#">AG11-P7W9M2DSXX</a> 60 ●
11.9W	3000K	90	34°	ON-OFF DALI-2	<a href="#">AG11-13W9M2OUXX</a> 14 ○ <a href="#">AG11-13W9M2DSXX</a> 60 ●

## Play Flat Round Adjustable

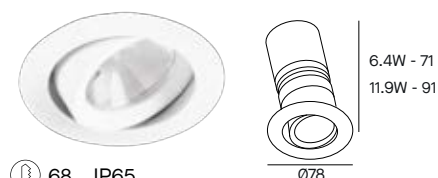

68 IP65

W LED	K	CRI	Optics	Source	Finishes
6.4W	3000K	90	28°	ON-OFF DALI-2	<a href="#">AG12-P7W9M2OUXX</a> 14 ○ <a href="#">AG12-P7W9M2DSXX</a> 60 ●
11.9W	3000K	90	34°	ON-OFF DALI-2	<a href="#">AG12-13W9M2OUXX</a> 14 ○ <a href="#">AG12-13W9M2DSXX</a> 60 ●

## Play High Visual Confort Round Fixed

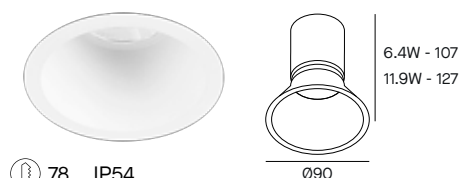

78 IP54

W LED	K	CRI	Optics	Source	Finishes
6.4W	3000K	90	28°	ON-OFF DALI-2	<a href="#">AG13-P7W9M2OUXX</a> 14 ○ <a href="#">AG13-P7W9M2DSXX</a> 60 ●
11.9W	3000K	90	34°	ON-OFF DALI-2	<a href="#">AG13-13W9M2OUXX</a> 14 ○ <a href="#">AG13-13W9M2DSXX</a> 60 ●

## Play High Visual Confort Round Adjustable

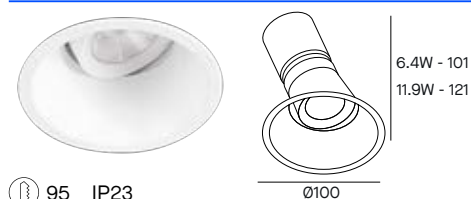

95 IP23

W LED	K	CRI	Optics	Source	Finishes
6.4W	3000K	90	28°	ON-OFF DALI-2	<a href="#">AG14-P7W9M2OUXX</a> 14 ○ <a href="#">AG14-P7W9M2DSXX</a> 60 ●
11.9W	3000K	90	34°	ON-OFF DALI-2	<a href="#">AG14-13W9M2OUXX</a> 14 ○ <a href="#">AG14-13W9M2DSXX</a> 60 ●

## Play Deep Round Fixed



58 IP54

W LED	K	CRI	Optics	Source	Finishes
6.4W	3000K	90	28°	ON-OFF DALI-2	<a href="#">AG15-P7W9M2OUXX</a> 14 ○ <a href="#">AG15-P7W9M2DSXX</a> 60 ●
11.9W	3000K	90	34°	ON-OFF DALI-2	<a href="#">AG15-13W9M2OUXX</a> 14 ○ <a href="#">AG15-13W9M2DSXX</a> 60 ●

### Play Round Fixed

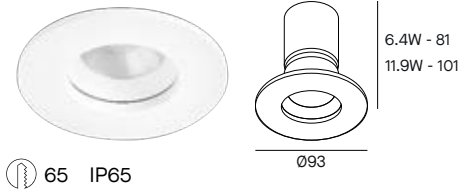

65 IP65

W LED	K	CRI	Optics	Source	Finishes
6.4W	3000K	90	28°	ON-OFF DALI-2	<a href="#">AG16-P7W9M2OUXX</a> 14 ○ <a href="#">AG16-P7W9M2DSXX</a> 60 ●
11.9W	3000K	90	34°	ON-OFF DALI-2	<a href="#">AG16-13W9M2OUXX</a> 14 ○ <a href="#">AG16-13W9M2DSXX</a> 60 ●

### Play Glass Round Fixed

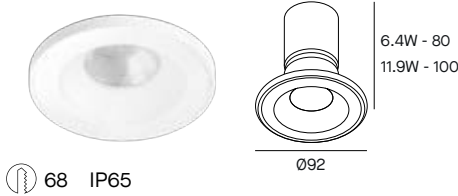

68 IP65

W LED	K	CRI	Optics	Source	Finishes
6.4W	3000K	90	28°	ON-OFF DALI-2	<a href="#">AG43-P7W9M2OU14</a> 14 ○ <a href="#">AG43-P7W9M2DS14</a>
11.9W	3000K	90	34°	ON-OFF DALI-2	<a href="#">AG43-13W9M2OU14</a> 14 ○ <a href="#">AG43-13W9M2DS14</a>

### Play Pinhole Round Fixed

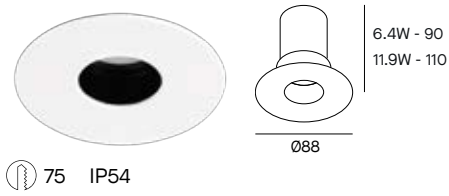

75 IP54

W LED	K	CRI	Optics	Source	Finishes
6.4W	3000K	90	28°	ON-OFF DALI-2	<a href="#">AG45-P7W9M2OU14</a> 14 ○ <a href="#">AG45-P7W9M2DS14</a>
11.9W	3000K	90	34°	ON-OFF DALI-2	<a href="#">AG45-13W9M2OU14</a> 14 ○ <a href="#">AG45-13W9M2DS14</a>

### Play Pinhole Round Adjustable

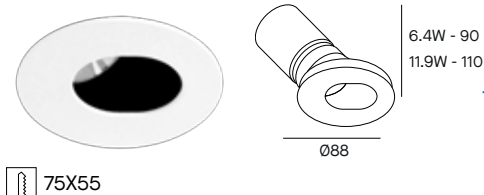

75X55

W LED	K	CRI	Optics	Source	Finishes
6.4W	3000K	90	28°	ON-OFF DALI-2	<a href="#">AG47-P7W9M2OU14</a> 14 ○ <a href="#">AG47-P7W9M2DS14</a>
11.9W	3000K	90	34°	ON-OFF DALI-2	<a href="#">AG47-13W9M2OU14</a> 14 ○ <a href="#">AG47-13W9M2DS14</a>

### Play Soft Round Adjustable



86 IP23

W LED	K	CRI	Optics	Source	Finishes
6.4W	3000K	90	28°	ON-OFF DALI-2	<a href="#">AG52-P7W9M2OUXX</a> 14 ○ <a href="#">AG52-P7W9M2DSXX</a> 60 ●
11.9W	3000K	90	34°	ON-OFF DALI-2	<a href="#">AG52-13W9M2OUXX</a> 14 ○ <a href="#">AG52-13W9M2DSXX</a> 60 ●

### Play Snoot Round Adjustable



85 IP23

W LED	K	CRI	Optics	Source	Finishes
6.4W	3000K	90	28°	ON-OFF DALI-2	<a href="#">AG56-P7W9M2OUXX</a> 14 ○ <a href="#">AG56-P7W9M2DSXX</a> 60 ●
11.9W	3000K	90	34°	ON-OFF DALI-2	<a href="#">AG56-13W9M2OUXX</a> 14 ○ <a href="#">AG56-13W9M2DSXX</a> 60 ●

BODY MAT
PC,AL

## Play Flat Mini

IP 23	DIF MAT PMMA	50000h L80 B20	2 MacAdam		
----------	-----------------	-------------------	--------------	--	--





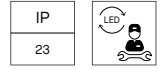

Ejemplo de código / Exemplo de código: **AG33-P2V8S10U14**

Model	W	K / CRI / Real lm	Optics	Source	Finishes
 <p><b>AG33 -</b> Redondo / Fijo Redondo / fixo 0-8 mm 40 IP54</p> <p> <input type="radio"/> 14   <input type="radio"/> 60  <input type="radio"/> 14   <input type="radio"/> 60                 </p> <p> <b>w</b>      <b>x</b>                  1,5 W    40                  3 W      30                  Ø45             </p>  <p><b>AG34 -</b> Redondo / Ajustable Redondo / ajustável 0-12 mm 42</p> <p> <input type="radio"/> 14   <input type="radio"/> 60   <input type="radio"/> AF  <input type="radio"/> 14   <input type="radio"/> 60   <input type="radio"/> AF                 </p> <p> <b>w</b>      <b>x</b>                  1,5 W    45                  3 W      35                  Ø52             </p>	<b>P2</b> 2.9W	<b>V8</b> 2700K / CRI 80 / 116 lm	<b>S1</b> 8°	<b>OU</b> ON-OFF 100-277V	<b>14</b> <b>60</b> <b>AF</b>
		<b>W8</b> 3000K / CRI 80 / 116 lm		<b>DS</b> DALI-2 220-240V	
		<b>X8</b> 4000K / CRI 80 / 116 lm		<b>BB</b> 3V/max.500mA	
	<b>P3</b> 4.4W	<b>V8</b> 2700K / CRI 80 / 348 lm (M2)	<b>M2</b> 28°	<b>OU</b> ON-OFF 100-277V	
		<b>W8</b> 3000K / CRI 80 / 348 lm (M2)		<b>DS</b> DALI-2 220-240V	
		<b>X8</b> 4000K / CRI 80 / 346 lm (M2)		<b>BB</b> 9V/max.350mA	

# Play Flat



Ejemplo de código / Exemplo de código: **AG11-P7V9S1OU14**

























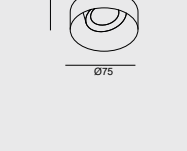

Model	W	K / CRI / Real lm	Optics	Source	Finishes										
 <p><b>AG11 -</b> Redondo / Fijo Redondo / fixo 0-7 mm 58</p> <p>○ ● 14 60</p> <table border="1"> <tr><th>w</th><th>x</th></tr> <tr><td>7 W</td><td>65</td></tr> <tr><td>13 W</td><td>85</td></tr> <tr><td>18 W</td><td>105</td></tr> <tr><td>GU10</td><td>75</td></tr> </table> <p>Ø65</p>	w	x	7 W	65	13 W	85	18 W	105	GU10	75	<b>P7</b> 8.5W	<b>V9</b> 2700K / CRI 90 / 582 lm (M2)	<b>S1</b> 8°	<b>OU</b> ON-OFF 100-240V	<b>14</b>  <b>60</b>  <b>AF</b> 
	w	x													
	7 W	65													
	13 W	85													
18 W	105														
GU10	75														
<b>W9</b> 3000K / CRI 90 / 674 lm (M2)	<b>M2</b> 28°	<b>TS</b> PHASE CUT 220-240V													
<b>X9</b> 4000K / CRI 90 / 674 lm (M2)	<b>F1</b> 49°	<b>DS</b> (SC) DALI-2/PUSH 220-240V													
		<b>BB</b> (SC) 9V/max.700mA													
 <p><b>AG12 -</b> Redondo / Ajustable Redondo / ajustável 0-20 mm 68</p> <p>○ ● ● 14 60 AF</p> <table border="1"> <tr><th>w</th><th>x</th></tr> <tr><td>7 W</td><td>70</td></tr> <tr><td>13 W</td><td>90</td></tr> <tr><td>18 W</td><td>110</td></tr> <tr><td>GU10</td><td>80</td></tr> </table> <p>Ø78</p>	w	x	7 W	70	13 W	90	18 W	110	GU10	80	<b>13</b> 14.3W	<b>V9</b> 2700K / CRI 90 / 1235lm (M2)	<b>S2</b> 22°	<b>OU</b> ON-OFF 100-240V	
	w	x													
	7 W	70													
	13 W	90													
18 W	110														
GU10	80														
<b>W9</b> 3000K / CRI 90 / 1330 lm (M2)	<b>M2</b> 33°	<b>TS</b> PHASE CUT 220-240V													
<b>X9</b> 4000K / CRI 90 / 1423 lm (M2)	<b>F1</b> 44°	<b>DS</b> (SC) DALI-2 220-240V													
		<b>BB</b> (SC) 36V/max.350mA													
 <p><b>AG19 -</b> Cuadrado / Fijo Quadrado / fixo 0-7 mm 58</p> <p>○ ● 14 60</p> <table border="1"> <tr><th>w</th><th>x</th></tr> <tr><td>7 W</td><td>65</td></tr> <tr><td>13 W</td><td>85</td></tr> <tr><td>18 W</td><td>105</td></tr> <tr><td>GU10</td><td>75</td></tr> </table> <p>65</p>	w	x	7 W	65	13 W	85	18 W	105	GU10	75	<b>18</b> 19.8W	<b>V9</b> 2700K / CRI 90 / 1707lm (M2)	<b>S2</b> 22°	<b>OU</b> ON-OFF 100-240V	
	w	x													
	7 W	65													
	13 W	85													
18 W	105														
GU10	75														
<b>W9</b> 3000K / CRI 90 / 1707 lm (M2)	<b>M2</b> 34°	<b>TS</b> PHASE CUT 220-240V													
<b>X9</b> 4000K / CRI 90 / 1707lm (M2)	<b>F1</b> 51°	<b>DS</b> (SC) DALI-2 220-240V													
		<b>BB</b> (SC) 36V/max.500mA													
 <p><b>AG21 -</b> Cuadrado / Ajustable Quadrado / ajustável 0-20 mm 68</p> <p>○ ● 14 60</p> <table border="1"> <tr><th>w</th><th>x</th></tr> <tr><td>7 W</td><td>70</td></tr> <tr><td>13 W</td><td>90</td></tr> <tr><td>18 W</td><td>110</td></tr> <tr><td>GU10</td><td>80</td></tr> </table> <p>78</p>	w	x	7 W	70	13 W	90	18 W	110	GU10	80	<b>AA</b> GU10	<b>G1</b>	<b>NA</b>	<b>BU</b> 220-240V	
	w	x													
	7 W	70													
	13 W	90													
18 W	110														
GU10	80														

## Play Deep

WELL





Ejemplo de código / Exemplo de código: **AG15-P7V9S10U14**

Model	W	K / CRI / Real lm	Optics	Source	Finishes										
 <p><b>AG15 -</b> Redondo / Fijo Redondo / fixo Ø 0-20 mm Ⓜ 58 IP54</p> <table border="1"> <thead> <tr> <th>w</th> <th>x</th> </tr> </thead> <tbody> <tr> <td>7 W</td> <td>80</td> </tr> <tr> <td>13 W</td> <td>100</td> </tr> <tr> <td>18 W</td> <td>120</td> </tr> <tr> <td>GU10</td> <td>90</td> </tr> </tbody> </table> 	w	x	7 W	80	13 W	100	18 W	120	GU10	90	<b>P7</b> 8.5W	<b>V9</b> 2700K / CRI 90 / 543 lm (M2)	<b>S1</b> 7° <b>S2</b> 14°	<b>OU</b>  ON-OFF 100-240V	<b>14</b>  <b>60</b> 
	w	x													
	7 W	80													
13 W	100														
18 W	120														
GU10	90														
<b>W9</b> 3000K / CRI 90 / 629 lm (M2)	<b>M2</b> 27°	<b>TS</b>  PHASE CUT 220-240V													
<b>X9</b> 4000K / CRI 90 / 629 lm (M2)	<b>F1</b> 49°	<b>DS</b>   DALI-2/PUSH 220-240V <b>BB</b>   9V/max.700mA													
 <p><b>AG17 -</b> Redondo / Ajustable / Sin marco Redondo / ajustável / trimless Ø 0-18 mm Ⓜ 75 IP23</p> <table border="1"> <thead> <tr> <th>w</th> <th>x</th> </tr> </thead> <tbody> <tr> <td>7 W</td> <td>95</td> </tr> <tr> <td>13 W</td> <td>115</td> </tr> <tr> <td>18 W</td> <td>135</td> </tr> <tr> <td>GU10</td> <td>105</td> </tr> </tbody> </table> 	w	x	7 W	95	13 W	115	18 W	135	GU10	105	<b>13</b> 14.3W	<b>V9</b> 2700K / CRI 90 / 998 lm (M2)	<b>S2</b> 18°	<b>OU</b>  ON-OFF 100-240V	
	w	x													
	7 W	95													
13 W	115														
18 W	135														
GU10	105														
<b>W9</b> 3000K / CRI 90 / 1074 lm (M2)	<b>M2</b> 34°	<b>TS</b>  PHASE CUT 220-240V													
<b>X9</b> 4000K / CRI 90 / 1149 lm (M2)	<b>F1</b> 44°	<b>DS</b>   DALI-2 220-240V <b>BB</b>   36V/max.350mA													
 <p><b>AG17 -</b> Redondo / Ajustable / Sin marco Redondo / ajustável / trimless Ø 0-18 mm Ⓜ 75 IP23</p> <table border="1"> <thead> <tr> <th>w</th> <th>x</th> </tr> </thead> <tbody> <tr> <td>7 W</td> <td>95</td> </tr> <tr> <td>13 W</td> <td>115</td> </tr> <tr> <td>18 W</td> <td>135</td> </tr> <tr> <td>GU10</td> <td>105</td> </tr> </tbody> </table> 	w	x	7 W	95	13 W	115	18 W	135	GU10	105	<b>18</b> 19.8W	<b>V9</b> 2700K / CRI 90 / 1557 lm (M2)	<b>S2</b> 19°	<b>OU</b>  ON-OFF 100-240V	
	w	x													
	7 W	95													
13 W	115														
18 W	135														
GU10	105														
<b>W9</b> 3000K / CRI 90 / 1676 lm (M2)	<b>M2</b> 33°	<b>TS</b>  PHASE CUT 220-240V													
<b>X9</b> 4000K / CRI 90 / 1793 lm (M2)	<b>F1</b> 47°	<b>DS</b>   DALI-2 220-240V <b>BB</b>   36V/max.500mA													
<b>AA</b> GU10	<b>G1</b>	<b>NA</b>	<b>BU</b>  220-240V												

## Play High Visual Comfort Mini

IP	DIF MAT	50000h	2		
54	PMMA	L80 B20	MacAdam		

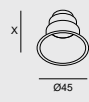

Ejemplo de código / Exemplo de código: **AG36-P2V8S10U14**

Model	W	K / CRI / Real lm	Optics	Source	Finishes						
 <p><b>AG36 -</b> Redondo / Fijo Redondo / fixo Ø 0-15 mm Ⓢ 40</p> <table border="1"> <tr> <td><b>w</b></td> <td><b>x</b></td> </tr> <tr> <td>1,5 W</td> <td>60</td> </tr> <tr> <td>3 W</td> <td>50</td> </tr> </table>  <p>Ø45</p>	<b>w</b>	<b>x</b>	1,5 W	60	3 W	50	<b>P2</b> 3.5W	<b>V8</b> 2700K / CRI 80 / 116 lm	<b>S1</b> 8°	<b>OU</b> ON-OFF 100-277V	<b>14</b> <b>60</b>
	<b>w</b>	<b>x</b>									
	1,5 W	60									
3 W	50										
<b>W8</b> 3000K / CRI 80 / 110 lm	<b>BB</b> 3V/max.500mA										
<b>X8</b> 4000K / CRI 80 / 110 lm											
 <p><b>AG41 -</b> Redondo / Fijo / Sin marco Redondo / fixo / trimless Ø 0-14 mm Ⓢ 36</p> <table border="1"> <tr> <td><b>w</b></td> <td><b>x</b></td> </tr> <tr> <td>1,5 W</td> <td>50</td> </tr> <tr> <td>3 W</td> <td>40</td> </tr> </table>  <p>Ø36</p>	<b>w</b>	<b>x</b>	1,5 W	50	3 W	40	<b>P3</b> 4.5W	<b>V8</b> 2700K / CRI 80 / 350 lm (M2)	<b>M2</b> 29°	<b>OU</b> ON-OFF 100-277V	
	<b>w</b>	<b>x</b>									
	1,5 W	50									
3 W	40										
<b>W8</b> 3000K / CRI 80 / 350 lm (M2)	<b>F1</b> 47°	<b>BB</b> 9V/max.350mA									
<b>X8</b> 4000K / CRI 80 / 337 lm (M2)											

## Play High Visual Comfort

IP	
23	

Ejemplo de código / Exemplo de código: **AG13-P7V9S10U14**

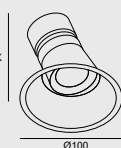
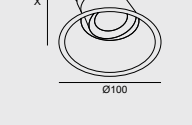
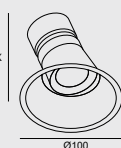
Model	W	K / CRI / Real lm	Optics	Source	Finishes										
 <p><b>AG13 -</b> Redondo / Fijo Redondo / fixo Ø 0-25 mm Ⓢ 78 IP54</p> <table border="1"> <tr> <td><b>w</b></td> <td><b>x</b></td> </tr> <tr> <td>7 W</td> <td>105</td> </tr> <tr> <td>13 W</td> <td>125</td> </tr> <tr> <td>18 W</td> <td>145</td> </tr> <tr> <td>GU10</td> <td>115</td> </tr> </table>  <p>Ø90</p>	<b>w</b>	<b>x</b>	7 W	105	13 W	125	18 W	145	GU10	115	<b>P7</b> 8.5W	<b>V9</b> 2700K / CRI 90 / 565 lm (M2)	<b>S1</b> 7°	<b>OU</b> ON-OFF 100-240V	<b>14</b> <b>60</b>
	<b>w</b>	<b>x</b>													
	7 W	105													
	13 W	125													
18 W	145														
GU10	115														
<b>W9</b> 3000K / CRI 90 / 655 lm (M2)	<b>S2</b> 14°														
<b>X9</b> 4000K / CRI 90 / 655 lm (M2)	<b>M2</b> 28°	<b>TS</b> PHASE CUT 220-240V													
	<b>F1</b> 48°	<b>DS</b> DALI-2/PUSH 220-240V													
 <p><b>AG14 -</b> Redondo / Ajustable Redondo / ajustável Ø 0-18 mm Ⓢ 90 IP23</p> <table border="1"> <tr> <td><b>w</b></td> <td><b>x</b></td> </tr> <tr> <td>7 W</td> <td>100</td> </tr> <tr> <td>13 W</td> <td>120</td> </tr> <tr> <td>18 W</td> <td>140</td> </tr> <tr> <td>GU10</td> <td>110</td> </tr> </table>  <p>Ø100</p>	<b>w</b>	<b>x</b>	7 W	100	13 W	120	18 W	140	GU10	110	<b>13</b> 14.3W	<b>V9</b> 2700K / CRI 90 / 1206 lm (M2)	<b>S2</b> 19°	<b>OU</b> ON-OFF 100-240V	
	<b>w</b>	<b>x</b>													
	7 W	100													
	13 W	120													
18 W	140														
GU10	110														
<b>W9</b> 3000K / CRI 90 / 1298 lm (M2)	<b>M2</b> 34°	<b>TS</b> PHASE CUT 220-240V													
<b>X9</b> 4000K / CRI 90 / 1389 lm (M2)	<b>F1</b> 44°	<b>DS</b> DALI-2 220-240V													
		<b>BB</b> 36V/max.350mA													
 <p><b>AG14 -</b> Redondo / Ajustable Redondo / ajustável Ø 0-18 mm Ⓢ 90 IP23</p> <table border="1"> <tr> <td><b>w</b></td> <td><b>x</b></td> </tr> <tr> <td>7 W</td> <td>100</td> </tr> <tr> <td>13 W</td> <td>120</td> </tr> <tr> <td>18 W</td> <td>140</td> </tr> <tr> <td>GU10</td> <td>110</td> </tr> </table>  <p>Ø100</p>	<b>w</b>	<b>x</b>	7 W	100	13 W	120	18 W	140	GU10	110	<b>18</b> 19.8W	<b>V9</b> 2700K / CRI 90 / 1570 lm (M2)	<b>S2</b> 19°	<b>OU</b> ON-OFF 100-240V	
	<b>w</b>	<b>x</b>													
	7 W	100													
	13 W	120													
18 W	140														
GU10	110														
<b>W9</b> 3000K / CRI 90 / 1690 lm (M2)	<b>M2</b> 33°	<b>TS</b> PHASE CUT 220-240V													
<b>X9</b> 4000K / CRI 90 / 1808 lm (M2)	<b>F1</b> 47°	<b>DS</b> DALI-2 220-240V													
		<b>BB</b> 36V/max.500mA													
<b>AA</b> GU10	<b>G1</b>	<b>NA</b>	<b>BU</b> 220-240V												



BODY MAT
PC,AL

## Play IP65 Mini

IP 65	DIF MAT PMMA	50000h L80 B20	2 MacAdam		
----------	-----------------	-------------------	--------------	--	--

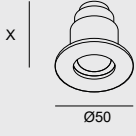

Ejemplo de código / Exemplo de código: **AG37-P2V8S10U14**

Model	W	K / CRI / Real lm	Optics	Source	Finishes						
 <p><b>AG37 -</b> Redondo / Fijo Redondo / fixo Ø 0-20 mm ⌀ 40</p>  <p>Ø50</p> <table border="1"> <tr><td><b>w</b></td><td><b>x</b></td></tr> <tr><td>1,5 W</td><td>45</td></tr> <tr><td>3 W</td><td>35</td></tr> </table>	<b>w</b>	<b>x</b>	1,5 W	45	3 W	35	<b>P2</b> 3.5W	<b>V8</b> 2700K / CRI 80 / 112 lm	<b>S1</b> 8°	<b>OU</b> ON-OFF 100-277V	<b>14</b> <b>60</b>
	<b>w</b>	<b>x</b>									
	1,5 W	45									
	3 W	35									
	<b>W8</b> 3000K / CRI 80 / 112 lm	<b>DS</b> DALI-2 220-240V									
	<b>X8</b> 4000K / CRI 80 / 112 lm	<b>BB</b> 3V/max.500mA									
<b>P3</b> 4.5W	<b>V8</b> 2700K / CRI 80 / 316 lm (M2)	<b>M2</b> 28°	<b>OU</b> ON-OFF 100-277V								
	<b>W8</b> 3000K / CRI 80 / 316 lm (M2)		<b>DS</b> DALI-2 220-240V								
	<b>X8</b> 4000K / CRI 80 / 306 lm (M2)		<b>BB</b> 9V/max.350mA								

## Play IP65

IP 65	
----------	--

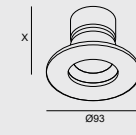

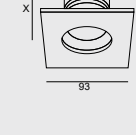







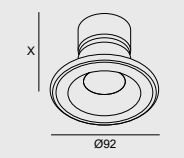



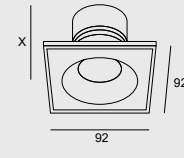

Ejemplo de código / Exemplo de código: **AG16-P7V9S10U14**

Model	W	K / CRI / Real lm	Optics	Source	Finishes										
 <p><b>AG16 -</b> Redondo / Fijo Redondo / fixo Ø 0-20 mm ⌀ 65</p>  <p>Ø93</p> <table border="1"> <tr><td><b>w</b></td><td><b>x</b></td></tr> <tr><td>7 W</td><td>80</td></tr> <tr><td>13 W</td><td>100</td></tr> <tr><td>18 W</td><td>120</td></tr> <tr><td>GU10</td><td>90</td></tr> </table>	<b>w</b>	<b>x</b>	7 W	80	13 W	100	18 W	120	GU10	90	<b>P7</b> 8.5W	<b>V9</b> 2700K / CRI 90 / 543 lm (M2)	<b>S1</b> 8°	<b>OU</b> ON-OFF 100-240V	<b>14</b> <b>60</b> <b>21</b>
	<b>w</b>	<b>x</b>													
	7 W	80													
	13 W	100													
	18 W	120													
	GU10	90													
<b>W9</b> 3000K / CRI 90 / 629 lm (M2)	<b>M2</b> 28°	<b>TS</b> PHASE CUT 220-240V													
<b>X9</b> 4000K / CRI 90 / 629 lm (M2)			<b>F1</b> 48°	<b>DS</b> DALI-2/PUSH 220-240V											
 <p><b>AG22 -</b> Cuadrado / Fijo Cuadrado / fixo Ø 0-20 mm ⌀ 65</p>  <p>Ø93</p> <table border="1"> <tr><td><b>w</b></td><td><b>x</b></td></tr> <tr><td>7 W</td><td>80</td></tr> <tr><td>13 W</td><td>100</td></tr> <tr><td>18 W</td><td>120</td></tr> <tr><td>GU10</td><td>90</td></tr> </table>	<b>w</b>	<b>x</b>	7 W	80	13 W	100	18 W	120	GU10	90	<b>13</b> 14.3W	<b>V9</b> 2700K / CRI 90 / 960 lm (M2)	<b>S2</b> 22°	<b>OU</b> ON-OFF 100-240V	
	<b>w</b>	<b>x</b>													
	7 W	80													
	13 W	100													
	18 W	120													
	GU10	90													
<b>W9</b> 3000K / CRI 90 / 1251 lm (M2)	<b>M2</b> 34°	<b>TS</b> PHASE CUT 220-240V													
<b>X9</b> 4000K / CRI 90 / 1339 lm (M2)			<b>F1</b> 44°	<b>DS</b> DALI-2 220-240V											
<b>18</b> 19.8W	<b>V9</b> 2700K / CRI 90 / 1459 lm (M2)	<b>S2</b> 21°	<b>OU</b> ON-OFF 100-240V												
	<b>W9</b> 3000K / CRI 90 / 1459 lm (M2)			<b>M2</b> 34°	<b>TS</b> PHASE CUT 220-240V										
	<b>X9</b> 4000K / CRI 90 / 1459 lm (M2)					<b>F1</b> 51°	<b>DS</b> DALI-2 220-240V								
<b>AA</b> GU10	<b>G1</b>	<b>NA</b>	<b>BU</b> 220-240V												
				<b>BB</b> 36V/max.500mA											

## Play Glass

IP	DIF MAT
65	GLA

Ejemplo de código / Exemplo de código: **AG43-P7V9S10U14**

Model	W	K / CRI / Real lm	Optics	Source	Finishes									
 <p><b>AG43 -</b> Redondo / Fijo Redondo / fixo Ø 0-20 mm Ⓟ 68</p> <table border="1"> <tr><td><b>w</b></td><td><b>x</b></td></tr> <tr><td>7 W</td><td>80</td></tr> <tr><td>13 W</td><td>100</td></tr> </table>  <p>Ø92</p>	<b>w</b>	<b>x</b>	7 W	80	13 W	100	<b>P7</b> 8.5W	<b>V9</b> 2700K / CRI 90 / 514 lm (M2)	<b>S1</b> 8°	<b>OU</b>  ON-OFF 100-240V	<b>14</b> 			
	<b>w</b>	<b>x</b>												
	7 W	80												
	13 W	100												
	<b>W9</b> 3000K / CRI 90 / 595 lm (M2)	<b>M2</b> 14°	<b>TS</b>  PHASE CUT 220-240V											
	<b>X9</b> 4000K / CRI 90 / 595 lm (M2)	<b>F1</b> 28°	<b>DS</b>  DALI-2/PUSH 220-240V											
	<b>BB</b>  9V/max.700mA													
 <p><b>AG44 -</b> Cuadrado / Fijo Cuadrado / fixo Ø 0-20 mm Ⓟ 68</p> <table border="1"> <tr><td><b>w</b></td><td><b>x</b></td></tr> <tr><td>7 W</td><td>80</td></tr> <tr><td>13 W</td><td>100</td></tr> <tr><td>18 W</td><td>120</td></tr> <tr><td>GU10</td><td>90</td></tr> </table>  <p>92</p>	<b>w</b>	<b>x</b>	7 W	80	13 W	100	18 W	120	GU10	90	<b>13</b> 14.3W	<b>V9</b> 2700K / CRI 90 / 1093 lm (M2)	<b>S2</b> 19°	<b>OU</b>  ON-OFF 100-240V
	<b>w</b>	<b>x</b>												
	7 W	80												
	13 W	100												
	18 W	120												
	GU10	90												
<b>W9</b> 3000K / CRI 90 / 1176 lm (M2)	<b>M2</b> 34°	<b>TS</b>  PHASE CUT 220-240V												
<b>X9</b> 4000K / CRI 90 / 1258 lm (M2)	<b>F1</b> 44°	<b>DS</b>  DALI-2 220-240V												
	<b>BB</b>  36V/max.350mA													
<b>18</b> 19.8W	<b>V9</b> 2700K / CRI 90 / 1621 lm (M2)	<b>S2</b> 20°	<b>OU</b>  ON-OFF 100-240V											
	<b>W9</b> 3000K / CRI 90 / 1621 lm (M2)	<b>M2</b> 34°	<b>TS</b>  PHASE CUT 220-240V											
	<b>X9</b> 4000K / CRI 90 / 1621 lm (M2)	<b>F1</b> 46°	<b>DS</b>  DALI-2 220-240V											
		<b>BB</b>  36V max. 500mA												
<b>AA</b> GU10	<b>G1</b>	<b>NA</b>	<b>BU</b>  100-240V											





BODY MAT
PC,AL

## Play Pinhole Mini

IP 23	UGR <16	50000h L80 B20	2 MacAdam		
----------	------------	-------------------	--------------	--	--

Ejemplo de código / Exemplo de código: **AG61-P2V8S10U14**

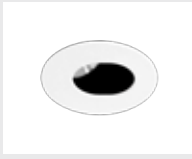
Model	W	K / CRI / Real lm	Optics	Source	Finishes
 <p><b>AG61 -</b> Redondo / Fijo Redondo / fixo 0-15 mm 55 IP54</p>  <p>W X 1,5 W 60 3 W 50</p>	P2 3.5W	V8 2700K / CRI 80 / 85 lm	S1 9°	OU  ON-OFF 100-277V	14 60
		W8 3000K / CRI 80 / 85 lm		DS   DALI-2 220-240V	
		X8 4000K / CRI 80 / 85 lm		BB   3V/max.500mA	
	P3 4.5W	V8 2700K / CRI 80 / 300 lm (M2)	M2 28°	OU  ON-OFF 100-277V	
		W8 3000K / CRI 80 / 319 lm (M2)		DS   DALI-2 220-240V	
		X8 4000K / CRI 80 / 319 lm (M2)		BB   9V/max.350mA	
 <p><b>AG62 -</b> Redondo / Ajustable Redondo / ajustável 0-15 mm 55 IP23</p>  <p>W X 1,5 W 60 3 W 50</p>					

Model	W	K / CRI / Real lm	Optics	Source	Finishes										
 <p><b>AG45 -</b> Redondo / Fijo Redondo / fixo Ø 0-18 mm Ⓢ 75 IP68</p> <table border="1"> <thead> <tr> <th>w</th> <th>x</th> </tr> </thead> <tbody> <tr> <td>7 W</td> <td>90</td> </tr> <tr> <td>13 W</td> <td>110</td> </tr> <tr> <td>18 W</td> <td>130</td> </tr> <tr> <td>GU10</td> <td>100</td> </tr> </tbody> </table>	w	x	7 W	90	13 W	110	18 W	130	GU10	100	<b>P7</b> 8.5W	<b>V9</b> 2700K / CRI 90 / 304 lm (M2)	<b>S1</b> 7°	<b>OU</b> ON-OFF 100-240V	<b>14</b>
	w	x													
7 W	90														
13 W	110														
18 W	130														
GU10	100														
<b>W9</b> 3000K / CRI 90 / 354 lm (M2)	<b>S2</b> 14°	<b>TS</b> PHASE CUT 220-240V													
		<b>X9</b> 4000K / CRI 90 / 354 lm (M2)	<b>F1</b> 48°	<b>DS</b> DALI-2/PUSH 220-240V											
				<b>BB</b> 9V/max.700mA											
 <p><b>AG46 -</b> Cuadrado / Fijo Quadrado / fixo Ø 0-18 mm Ⓢ 75x55 IP54</p> <table border="1"> <thead> <tr> <th>w</th> <th>x</th> </tr> </thead> <tbody> <tr> <td>7 W</td> <td>90</td> </tr> <tr> <td>13 W</td> <td>110</td> </tr> <tr> <td>18 W</td> <td>130</td> </tr> <tr> <td>GU10</td> <td>100</td> </tr> </tbody> </table>	w	x	7 W	90	13 W	110	18 W	130	GU10	100	<b>13</b> 14.3W	<b>V9</b> 2700K / CRI 90 / 1057 lm (M2)	<b>S2</b> 19°	<b>OU</b> ON-OFF 100-240V	
	w	x													
7 W	90														
13 W	110														
18 W	130														
GU10	100														
<b>W9</b> 3000K / CRI 90 / 1124 lm (M2)	<b>M2</b> 32°	<b>TS</b> PHASE CUT 220-240V													
		<b>X9</b> 4000K / CRI 90 / 1214 lm (M2)	<b>F1</b> 45°	<b>DS</b> DALI-2 220-240V											
				<b>BB</b> 36V/max.350mA											
 <p><b>AG47 -</b> Redondo / Ajustable Redondo / ajustável Ø 0-18 mm Ⓢ 75x55 IP23</p> <table border="1"> <thead> <tr> <th>w</th> <th>x</th> </tr> </thead> <tbody> <tr> <td>7 W</td> <td>90</td> </tr> <tr> <td>13 W</td> <td>110</td> </tr> <tr> <td>18 W</td> <td>130</td> </tr> <tr> <td>GU10</td> <td>100</td> </tr> </tbody> </table>	w	x	7 W	90	13 W	110	18 W	130	GU10	100	<b>18</b> 19.8W	<b>V9</b> 2700K / CRI 90 / 1147 lm (M2)	<b>S2</b> 18°	<b>OU</b> ON-OFF 100-240V	
	w	x													
7 W	90														
13 W	110														
18 W	130														
GU10	100														
<b>W9</b> 3000K / CRI 90 / 1221 lm (M2)	<b>M2</b> 29°	<b>TS</b> PHASE CUT 220-240V													
		<b>X9</b> 4000K / CRI 90 / 1318 lm (M2)	<b>F1</b> 46°	<b>DS</b> DALI-2 220-240V											
				<b>BB</b> 36V/max.500mA											
 <p><b>AG48 -</b> Cuadrado / ajustable Quadrado / ajustável Ø 0-18 mm Ⓢ 75x75 IP23</p> <table border="1"> <thead> <tr> <th>w</th> <th>x</th> </tr> </thead> <tbody> <tr> <td>7 W</td> <td>90</td> </tr> <tr> <td>13 W</td> <td>110</td> </tr> <tr> <td>18 W</td> <td>130</td> </tr> <tr> <td>GU10</td> <td>100</td> </tr> </tbody> </table>	w	x	7 W	90	13 W	110	18 W	130	GU10	100	<b>AA</b> GU10	<b>G1</b>	<b>NA</b>	<b>BU</b> 100-240V	
	w	x													
7 W	90														
13 W	110														
18 W	130														
GU10	100														

BODY MAT
PC,AL

## Play Soft Mini

IP 23	UGR <16	50000h L80 B20	2 MacAdam	35°	
----------	------------	-------------------	--------------	-----	--

Ejemplo de código / Exemplo de código: **AG64-P2V8S10U14**

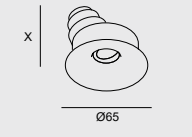
Model	W	K / CRI / Real lm	Optics	Source	Finishes
 <p><b>AG64 -</b> Redondo / Ajustable Redondo / ajustável 0-15 mm <math>\Phi</math> 55</p>  <p>W X 1,5 W 60 3 W 50</p>	<b>P2</b> 3.5W	<b>V8</b> 2700K / CRI 80 / 90 lm	<b>S1</b> 7°	<b>OU</b> ON-OFF 100-277V	<b>14</b> <b>60</b>
		<b>W8</b> 3000K / CRI 80 / 90 lm		<b>DS</b> DALI-2 220-240V	
		<b>X8</b> 4000K / CRI 80 / 90 lm		<b>BB</b> 3V/max.500mA	
	<b>P3</b> 4.5W	<b>V8</b> 2700K / CRI 80 / 300 lm (M2)	<b>M2</b> 28°	<b>OU</b> ON-OFF 100-277V	
		<b>W8</b> 3000K / CRI 80 / 319 lm (M2)		<b>DS</b> DALI-2 220-240V	
		<b>X8</b> 4000K / CRI 80 / 319 lm (M2)		<b>BB</b> 9V/max.350mA	

## Play Soft

IP 23		
----------	--	--

Ejemplo de código / Exemplo de código: **AG52-P7V9S10U14**

Model	W	K / CRI / Real lm	Optics	Source	Finishes	
 <p><b>AG52 -</b> Redondo / Ajustable Redondo / ajustável 0-20 mm <math>\Phi</math> 86 IP<math>\geq</math>55</p>  <p>W X 7 W 95 13 W 115 18 W 135 GU10 85</p>	<b>P7</b> 8.5W	<b>V9</b> 2700K / CRI 90 / 435 lm (M2)	<b>S1</b> 7°	<b>OU</b> ON-OFF 100-240V	<b>14</b> <b>60</b>	
		<b>W9</b> 3000K / CRI 90 / 504 lm (M2)				<b>M2</b> 26°
		<b>X9</b> 4000K / CRI 90 / 504 lm (M2)	<b>F1</b> 47°	<b>DS</b> DALI-2/PUSH 220-240V		
	 <p><b>AG53 -</b> Redondo / Ajustable/ Sin marco Redondo / ajustável</p> <p>/ sem aro 0-18 mm <math>\Phi</math> 102 IP23</p>  <p>W X 7 W 95 13 W 115 18 W 135 GU10 85</p>	<b>13</b> 14.3W	<b>V9</b> 2700K / CRI 90 / 1163 lm (M2)	<b>S2</b> 18°		<b>OU</b> ON-OFF 100-240V
			<b>W9</b> 3000K / CRI 90 / 1237 lm (M2)			
			<b>X9</b> 4000K / CRI 90 / 1336 lm (M2)	<b>F1</b> 46°		<b>DS</b> DALI-2 220-240V
 <p><b>AG55 -</b> Cuadrado / ajustable Quadrado / ajustável 0-18 mm <math>\square</math> 85x85 IP23</p>  <p>W X 7 W 110 13 W 130 18 W 150 GU10 100</p>		<b>18</b> 19.8W	<b>V9</b> 2700K / CRI 90 / 1610 lm (M2)	<b>S2</b> 22°	<b>OU</b> ON-OFF 100-240V	
			<b>W9</b> 3000K / CRI 90 / 1610 lm (M2)			<b>M2</b> 33°
			<b>X9</b> 4000K / CRI 90 / 1610 lm (M2)	<b>F1</b> 51°	<b>DS</b> DALI-2 220-240V	
	<b>AA</b> GU10W	<b>G1</b>			<b>BB</b> 36V/max.500mA	
					<b>BU</b> 100-240V	

## Play Snoot Mini

IP	UGR	50000h	2		
23	<22	L80 B20	MacAdam		



Ejemplo de código / Exemplo de código: **AG65-P2V8S10U14**

Model	W	K / CRI / Real lm	Optics	Source	Finishes						
 <p><b>AG65 -</b> Redondo / Ajustable Redondo / ajustável 0-15 mm 60 IP23 +/-40° 320°</p>  <table border="1"> <tr> <td><b>w</b></td> <td><b>x</b></td> </tr> <tr> <td>1,5 W</td> <td>50</td> </tr> <tr> <td>3 W</td> <td>40</td> </tr> </table>	<b>w</b>	<b>x</b>	1,5 W	50	3 W	40	<b>P2</b> 3.5W	<b>V8</b> 2700K / CRI 80 / 97 lm	<b>S1</b> 11°	<b>OU</b> ON-OFF 100-277V	<b>14</b> <b>60</b>
	<b>w</b>	<b>x</b>									
	1,5 W	50									
	3 W	40									
	<b>W8</b> 3000K / CRI 80 / 97 lm	<b>DS</b> DALI-2 220-240V									
	<b>X8</b> 4000K / CRI 80 / 97 lm	<b>BB</b> 3V/max.500mA									
<b>P3</b> 4.5W	<b>V8</b> 2700K / CRI 80 / 310 lm (M2)	<b>M2</b> 28°	<b>OU</b> ON-OFF 100-277V								
	<b>W8</b> 3000K / CRI 80 / 329 lm (M2)		<b>F1</b> DALI-2 220-240V								
	<b>X8</b> 4000K / CRI 80 / 329 lm (M2)		<b>BB</b> 9V/max.350mA								

## Play Snoot

IP		
23		

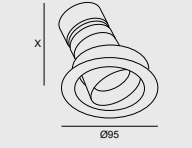
Ejemplo de código / Exemplo de código: **AG56-P7V9S10U14**

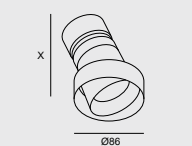
Model	W	K / CRI / Real lm	Optics	Source	Finishes										
 <p><b>AG56 -</b> Redondo / Ajustable Redondo / ajustável 0-20 mm 85 IP23 +/-40° 320°</p>  <table border="1"> <tr> <td><b>w</b></td> <td><b>x</b></td> </tr> <tr> <td>7 W</td> <td>80</td> </tr> <tr> <td>13 W</td> <td>100</td> </tr> <tr> <td>18 W</td> <td>120</td> </tr> <tr> <td>GU10</td> <td>70</td> </tr> </table>	<b>w</b>	<b>x</b>	7 W	80	13 W	100	18 W	120	GU10	70	<b>P7</b> 8.5W	<b>V9</b> 2700K / CRI 90 / 507 lm (M2)	<b>S1</b> 8°	<b>OU</b> ON-OFF 100-240V	<b>14</b> <b>60</b>
	<b>w</b>	<b>x</b>													
	7 W	80													
	13 W	100													
	18 W	120													
	GU10	70													
<b>W9</b> 3000K / CRI 90 / 590 lm (M2)	<b>M2</b> 27°	<b>TS</b> PHASE CUT 220-240V													
<b>X9</b> 4000K / CRI 90 / 590 lm (M2)		<b>F1</b> 48°	<b>DS</b> DALI-2/PUSH 220-240V												
 <p><b>AG57 -</b> Redondo / Ajustable / Sin marco Redondo / ajustável / sem aro 0-18 mm 87 IP23 40° 320°</p>  <table border="1"> <tr> <td><b>w</b></td> <td><b>x</b></td> </tr> <tr> <td>7 W</td> <td>90</td> </tr> <tr> <td>13 W</td> <td>110</td> </tr> <tr> <td>18 W</td> <td>125</td> </tr> <tr> <td>GU10</td> <td>90</td> </tr> </table>	<b>w</b>	<b>x</b>	7 W	90	13 W	110	18 W	125	GU10	90	<b>13</b> 14.3W	<b>V9</b> 2700K / CRI 90 / 1131 lm (M2)	<b>S2</b> 19°	<b>OU</b> ON-OFF 100-240V	
	<b>w</b>	<b>x</b>													
	7 W	90													
	13 W	110													
	18 W	125													
	GU10	90													
<b>W9</b> 3000K / CRI 90 / 1203 lm (M2)	<b>M2</b> 34°	<b>TS</b> PHASE CUT 220-240V													
<b>X9</b> 4000K / CRI 90 / 1300 lm (M2)		<b>F1</b> 44°	<b>DS</b> DALI-2 220-240V												
<b>18</b> 19.8W	<b>V9</b> 2700K / CRI 90 / 1453 lm (M2)	<b>S2</b> 19°	<b>OU</b> ON-OFF 100-240V												
	<b>W9</b> 3000K / CRI 90 / 1546 lm (M2)			<b>M2</b> 33°	<b>TS</b> PHASE CUT 220-240V										
	<b>X9</b> 4000K / CRI 90 / 1670 lm (M2)	<b>F1</b> 46°	<b>DS</b> DALI-2 220-240V												
	<b>AA</b> GU10W	<b>G1</b>	<b>NA</b>	<b>BU</b> 100-240V											

BODY MAT
PC,AL

## Play Raw Racy Gold Mini

IP	50000h	2		
54	L80 B20	MacAdam		

Ejemplo de código / Exemplo de código: **AG66-P2V8S10UEP**

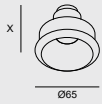
Model	W	K / CRI / Real lm	Optics	Source	Finishes						
 <p><b>AG66 -</b> Redondo / Fijo Redondo / fixo 0-16 mm 55 IP54</p>  <table border="1"> <tr> <td><b>W</b></td> <td><b>X</b></td> </tr> <tr> <td>1,5 W</td> <td>60</td> </tr> <tr> <td>3 W</td> <td>50</td> </tr> </table> <p>Ø65</p>	<b>W</b>	<b>X</b>	1,5 W	60	3 W	50	<b>P2</b> 3.5W	<b>V8</b> 2700K / CRI 80 / 94 lm	<b>S1</b> 6°	<b>OU</b> ON-OFF 100-277V	<b>EP</b>
	<b>W</b>	<b>X</b>									
	1,5 W	60									
	3 W	50									
	<b>W8</b> 3000K / CRI 80 / 94 lm	<b>DS</b> DALI-2 220-240V									
	<b>X8</b> 4000K / CRI 80 / 94 lm	<b>BB</b> 3V/max.500mA									
<b>P3</b> 4.5W	<b>V8</b> 2700K / CRI 80 / 319 lm (M2)	<b>M2</b> 29°	<b>OU</b> ON-OFF 100-277V								
	<b>W8</b> 3000K / CRI 80 / 340 lm (M2)		<b>F1</b> DALI-2 220-240V								
	<b>X8</b> 4000K / CRI 80 / 340 lm (M2)		<b>BB</b> 9V/max.350mA								

## Play Raw Racy Gold

IP		
54		

Ejemplo de código / Exemplo de código: **AG58-P7V9S10UEP**

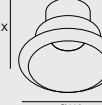
Model	W	K / CRI / Real lm	Optics	Source	Finishes										
 <p><b>AG58 -</b> Redondo / Fijo Redondo / fixo 0-27 mm 102 IP54</p>  <table border="1"> <tr> <td><b>W</b></td> <td><b>X</b></td> </tr> <tr> <td>7 W</td> <td>105</td> </tr> <tr> <td>13 W</td> <td>125</td> </tr> <tr> <td>18 W</td> <td>145</td> </tr> <tr> <td>GU10</td> <td>95</td> </tr> </table> <p>Ø110</p>	<b>W</b>	<b>X</b>	7 W	105	13 W	125	18 W	145	GU10	95	<b>P7</b> 8.5W	<b>V9</b> 2700K / CRI 90 / 539 lm (M2)	<b>S1</b> 7°	<b>OU</b> ON-OFF 100-240V	<b>EP</b>
	<b>W</b>	<b>X</b>													
	7 W	105													
	13 W	125													
	18 W	145													
	GU10	95													
	<b>W9</b> 3000K / CRI 90 / 624 lm (M2)	<b>M2</b> 28°	<b>TS</b> PHASE CUT 220-240V												
	<b>X9</b> 4000K / CRI 90 / 624 lm (M2)		<b>F1</b> 49°	<b>DS</b> DALI-2/PUSH 220-240V											
	<b>13</b> 14.3W	<b>V9</b> 2700K / CRI 90 / 1125 lm (M2)	<b>S2</b> 14°	<b>BB</b> 9V/max.700mA											
				<b>OU</b> ON-OFF 100-240V											
				<b>TS</b> PHASE CUT 220-240V											
		<b>W9</b> 3000K / CRI 90 / 1211 lm (M2)	<b>M2</b> 34°	<b>DS</b> DALI-2 220-240V											
				<b>BB</b> 36V/max.350mA											
				<b>F1</b> 45°											
	<b>18</b> 19.8W	<b>V9</b> 2700K / CRI 90 / 1520 lm (M2)	<b>S2</b> 19°	<b>OU</b> ON-OFF 100-240V											
<b>TS</b> PHASE CUT 220-240V															
<b>DS</b> DALI-2 220-240V															
<b>W9</b> 3000K / CRI 90 / 1636 lm (M2)		<b>M2</b> 33°	<b>BB</b> 36V/max.500mA												
			<b>OU</b> ON-OFF 100-240V												
			<b>TS</b> PHASE CUT 220-240V												
<b>X9</b> 4000K / CRI 90 / 1751 lm (M2)	<b>F1</b> 47°	<b>DS</b> DALI-2 220-240V													
		<b>BB</b> 36V/max.500mA													
		<b>F1</b> 47°													
<b>AA</b> GU10W	<b>G1</b>	<b>NA</b>	<b>BU</b> 100-240V												



# Play Raw Mini

IP	50000h	2		
54	L80 B20	MacAdam		





Ejemplo de código / Exemplo de código: **AG67-P2V8S10U55**

Model	W	K / CRI / Real lm	Optics	Source	Finishes	
 <p><b>AG67 -</b> Redondo / Ajustable Redondo / ajustável Ø 0-16 mm Ⓜ 57 IP54</p> 	<b>P2</b> 3.5W	<b>V8</b> 2700K / CRI 80 / 79 lm	<b>S1</b> 6°	<b>OU</b> ON-OFF 100-277V	  	
		<b>W8</b> 3000K / CRI 80 / 79 lm		<b>DS</b> DALI-2 220-240V		
		<b>X8</b> 4000K / CRI 80 / 79 lm		<b>BB</b> 3V/max.500mA		
	<b>P3</b> 4.5W	<b>V8</b> 2700K / CRI 80 / 268 lm (M2)	<b>M2</b> 29°	<b>OU</b> ON-OFF 100-277V		
		<b>W8</b> 3000K / CRI 80 / 285 lm (M2)		<b>F1</b> 47°		<b>DS</b> DALI-2 220-240V
		<b>X8</b> 4000K / CRI 80 / 285 lm (M2)		<b>BB</b> 9V/max.350mA		

# Play Raw

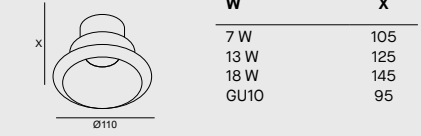
IP		
54		

Ejemplo de código / Exemplo de código: **AG59-P7V9S10U55**



Model	W	K / CRI / Real lm	Optics	Source	Finishes					
 <p><b>AG59 -</b> Redondo / Fijo Redondo / fixo Ø 0-36 mm Ⓜ 111 IP54</p> 	<b>P7</b> 8.5W	<b>V9</b> 2700K / CRI 90 / 535 lm (M2)	<b>S1</b> 7°	<b>OU</b> ON-OFF 100-240V	   					
		<b>S2</b> 15°								
		<b>W9</b> 3000K / CRI 90 / 622 lm (M2)	<b>M2</b> 32°	<b>TS</b> PHASE CUT 220-240V						
		<b>X9</b> 4000K / CRI 90 / 622 lm (M2)				<b>F1</b> 49°	<b>DS</b> DALI-2/PUSH 220-240V			
		<b>13</b> 14.3W	<b>V9</b> 2700K / CRI 90 / 1250 lm (M2)	<b>S2</b> 20°				<b>OU</b> ON-OFF 100-240V	<b>BB</b> 9V/max.700mA	
						<b>W9</b> 3000K / CRI 90 / 1330 lm (M2)	<b>M2</b> 34°			<b>TS</b> PHASE CUT 220-240V
	<b>X9</b> 4000K / CRI 90 / 1436 lm (M2)		<b>F1</b> 46°	<b>DS</b> DALI-2 220-240V						
	<b>18</b> 19.8W					<b>V9</b> 2700K / CRI 90 / 1624 lm (M2)	<b>S2</b> 20°	<b>OU</b> ON-OFF 100-240V	<b>BB</b> 36V/max.350mA	
			<b>W9</b> 3000K / CRI 90 / 1728 lm (M2)	<b>M2</b> 33°						<b>TS</b> PHASE CUT 220-240V
			<b>X9</b> 4000K / CRI 90 / 1866 lm (M2)							
	<b>AA</b> GU10W	<b>G1</b>	<b>NA</b>	<b>BU</b> 100-240V						

BODY MAT
PC,AL

## Play Deco Symmetrical Trim

IP	LED
54	

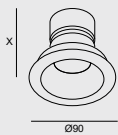

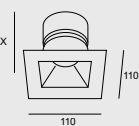

Ejemplo de código / Exemplo de código: **AG23-P7V9S10UWR**

Model	W	K / CRI / Real lm	Optics	Source	Finishes										
 <p><b>AG23 -</b> Redondo / Fijo Redondo / fixo Ø 0-25 mm Ⓢ 80 IP54</p> <table border="1"> <tr> <th>W</th> <th>X</th> </tr> <tr> <td>7 W</td> <td>90</td> </tr> <tr> <td>13 W</td> <td>110</td> </tr> <tr> <td>18 W</td> <td>130</td> </tr> <tr> <td>GU10</td> <td>80</td> </tr> </table> 	W	X	7 W	90	13 W	110	18 W	130	GU10	80	<b>P7</b> 8.5W	<b>V9</b> 2700K / CRI 90 / 571 lm (M2)	<b>S1</b> 8°	<b>OU</b> ON-OFF 100-240V	<b>WR</b>
	W	X													
	7 W	90													
	13 W	110													
	18 W	130													
	GU10	80													
<b>W9</b> 3000K / CRI 90 / 662 lm (M2)	<b>S2</b> 14°	<b>TS</b> PHASE CUT 220-240V	<b>WG</b>												
<b>X9</b> 4000K / CRI 90 / 662 lm (M2)	<b>M2</b> 28°	<b>DS</b> DALI-2/PUSH 220-240V	<b>WH</b>												
 <p><b>AG27 -</b> Cuadrado / Fijo Cuadrado / fixo Ø 0-25 mm Ⓢ 100 IP54</p> <table border="1"> <tr> <th>W</th> <th>X</th> </tr> <tr> <td>7 W</td> <td>90</td> </tr> <tr> <td>13 W</td> <td>110</td> </tr> <tr> <td>18 W</td> <td>130</td> </tr> <tr> <td>GU10</td> <td>80</td> </tr> </table> 	W	X	7 W	90	13 W	110	18 W	130	GU10	80	<b>13</b> 14.3W	<b>V9</b> 2700K / CRI 90 / 905 lm (M2)	<b>S2</b> 21°	<b>OU</b> ON-OFF 100-240V	<b>WI</b>
	W	X													
	7 W	90													
	13 W	110													
	18 W	130													
	GU10	80													
<b>W9</b> 3000K / CRI 90 / 1315 lm (M2)	<b>M2</b> 34°	<b>TS</b> PHASE CUT 220-240V	<b>WJ</b>												
<b>X9</b> 4000K / CRI 90 / 1407 lm (M2)	<b>F1</b> 45°	<b>DS</b> DALI-2 220-240V	<b>WK</b>												
<b>18</b> 19.8W	<b>V9</b> 2700K / CRI 90 / 1554 lm (M2)	<b>S2</b> 21°	<b>OU</b> ON-OFF 100-240V	<b>WL</b>											
	<b>W9</b> 3000K / CRI 90 / 1554 lm (M2)	<b>M2</b> 34°	<b>TS</b> PHASE CUT 220-240V	<b>WM</b>											
	<b>X9</b> 4000K / CRI 90 / 1554 lm (M2)	<b>F1</b> 51°	<b>DS</b> DALI-2 220-240V	<b>WN</b>											
		<b>BB</b> 36V/max.350mA													
<b>AA</b> GU10W	<b>G1</b>	<b>NA</b>	<b>BU</b> 220-240V												

# Play Deco Symmetrical Trimless

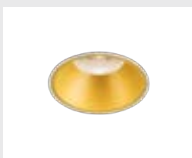
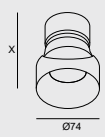



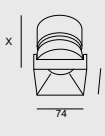



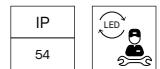

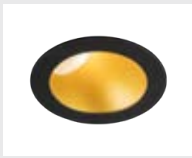
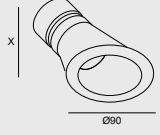

Ejemplo de código / Exemplo de código: **AG24-P7V9S10UWP**

Model	W	K / CRI / Real lm	Optics	Source	Finishes										
 <p><b>AG24 -</b> Redondo / Fijo / Sin marco Redondo / fixo / trimless Ø 0-21 mm Ⓢ 75 IP54</p>  <table border="1"> <tr><th>w</th><th>x</th></tr> <tr><td>7 W</td><td>95</td></tr> <tr><td>13 W</td><td>115</td></tr> <tr><td>18 W</td><td>135</td></tr> <tr><td>GU10</td><td>85</td></tr> </table>	w	x	7 W	95	13 W	115	18 W	135	GU10	85	<b>P7</b> 8.5W	<b>V9</b> 2700K / CRI 90 / 571 lm (M2)	<b>S1</b> 8°	<b>OU</b> ON-OFF 100-240V	<b>WP</b>  <b>WS</b>  <b>WQ</b> 
	w	x													
	7 W	95													
	13 W	115													
	18 W	135													
	GU10	85													
<b>W9</b> 3000K / CRI 90 / 662 lm (M2)	<b>S2</b> 14°	<b>TS</b> PHASE CUT 220-240V													
<b>X9</b> 4000K / CRI 90 / 662 lm (M2)	<b>M2</b> 28°	<b>DS</b> DALI-2/PUSH 220-240V													
<b>13</b> 14.3W	<b>V9</b> 2700K / CRI 90 / 1222 lm (M2)	<b>S2</b> 19°	<b>OU</b> ON-OFF 100-240V												
	<b>W9</b> 3000K / CRI 90 / 1315 lm (M2)	<b>M2</b> 34°	<b>TS</b> PHASE CUT 220-240V												
	<b>X9</b> 4000K / CRI 90 / 1407 lm (M2)	<b>F1</b> 45°	<b>DS</b> DALI-2 220-240V												
 <p><b>AG28 -</b> Cuadrado / Fijo / Sin marco Quadrado / fixo / trimless 0-25 mm Ⓢ 75x75 IP54</p>  <table border="1"> <tr><th>w</th><th>x</th></tr> <tr><td>7 W</td><td>95</td></tr> <tr><td>13 W</td><td>115</td></tr> <tr><td>18 W</td><td>135</td></tr> <tr><td>GU10</td><td>85</td></tr> </table>	w	x	7 W	95	13 W	115	18 W	135	GU10	85	<b>18</b> 19.8W	<b>V9</b> 2700K / CRI 90 / 1596 lm (M2)	<b>S2</b> 19°	<b>OU</b> ON-OFF 100-240V	
	w	x													
	7 W	95													
	13 W	115													
	18 W	135													
	GU10	85													
<b>W9</b> 3000K / CRI 90 / 1718 lm (M2)	<b>M2</b> 33°	<b>TS</b> PHASE CUT 220-240V													
<b>X9</b> 4000K / CRI 90 / 1838 lm (M2)	<b>F1</b> 47°	<b>DS</b> DALI-2 220-240V													
<b>AA</b> GU10W	<b>G1</b>	<b>NA</b>	<b>BB</b> 36V/max.500mA	<b>BU</b> 220-240V											

# Play Deco Asymmetrical Trim

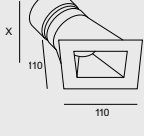

Ejemplo de código / Exemplo de código: **AG25-P7V9S10UWP**

Model	W	K / CRI / Real lm	Optics	Source	Finishes										
 <p><b>AG25 -</b> Redondo / Fijo Redondo / fixo 0-25 mm Ⓢ 80 IP54</p>  <table border="1"> <tr><th>w</th><th>x</th></tr> <tr><td>7 W</td><td>95</td></tr> <tr><td>13 W</td><td>115</td></tr> <tr><td>18 W</td><td>135</td></tr> <tr><td>GU10</td><td>85</td></tr> </table>	w	x	7 W	95	13 W	115	18 W	135	GU10	85	<b>P7</b> 8.5W	<b>V9</b> 2700K / CRI 90 / 528 lm (M2)	<b>S1</b> 8°	<b>OU</b> ON-OFF 100-240V	<b>WR</b>  <b>WG</b>  <b>WH</b>  <b>WI</b>  <b>WJ</b>  <b>WK</b>  <b>WL</b>  <b>WM</b>  <b>WN</b> 
	w	x													
	7 W	95													
	13 W	115													
	18 W	135													
	GU10	85													
<b>W9</b> 3000K / CRI 90 / 612 lm (M2)	<b>S2</b> 14°	<b>TS</b> PHASE CUT 220-240V													
<b>X9</b> 4000K / CRI 90 / 612 lm (M2)	<b>M2</b> 27°	<b>DS</b> DALI-2/PUSH 220-240V													
<b>13</b> 14.3W	<b>V9</b> 2700K / CRI 90 / 835 lm (M2)	<b>S2</b> 20°	<b>OU</b> ON-OFF 100-240V												
	<b>W9</b> 3000K / CRI 90 / 1218 lm (M2)	<b>M2</b> 33°	<b>TS</b> PHASE CUT 220-240V												
	<b>X9</b> 4000K / CRI 90 / 1303 lm (M2)	<b>F1</b> 45°	<b>DS</b> DALI-2 220-240V												
 <p><b>AG29 -</b> Cuadrado / Fijo Quadrado / fixo 0-25 mm Ⓢ 100 IP54</p>  <table border="1"> <tr><th>w</th><th>x</th></tr> <tr><td>7 W</td><td>90</td></tr> <tr><td>13 W</td><td>110</td></tr> <tr><td>18 W</td><td>125</td></tr> <tr><td>GU10</td><td>90</td></tr> </table>	w	x	7 W	90	13 W	110	18 W	125	GU10	90	<b>18</b> 19.8W	<b>V9</b> 2700K / CRI 90 / 1532 lm (M2)	<b>S2</b> 21°	<b>OU</b> ON-OFF 100-240V	
	w	x													
	7 W	90													
	13 W	110													
	18 W	125													
	GU10	90													
<b>W9</b> 3000K / CRI 90 / 1532 lm (M2)	<b>M2</b> 33°	<b>TS</b> PHASE CUT 220-240V													
<b>X9</b> 4000K / CRI 90 / 1532 lm (M2)	<b>F1</b> 47°	<b>DS</b> DALI-2 220-240V													
<b>AA</b> GU10W	<b>G1</b>	<b>NA</b>	<b>BB</b> 36V/max.500mA	<b>BU</b> 220-240V											

INDOOR





DOWNLIGHTS

# Play Deco Asymmetrical Trimless

IP  
54

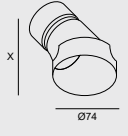

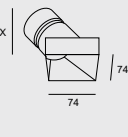
Ejemplo de código / Exemplo de código: **AG26-P7V9S10UWP**

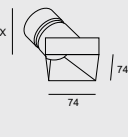



Model	W	K / CRI / Real lm	Optics	Source	Finishes										
 <p><b>AG26 -</b> Redondo / Fijo / Sin marco Redondo / fixo / trimless 0-15 mm 75 IP54</p>  <table border="1"> <tr><th>W</th><th>X</th></tr> <tr><td>7 W</td><td>95</td></tr> <tr><td>13 W</td><td>115</td></tr> <tr><td>18 W</td><td>125</td></tr> <tr><td>GU10</td><td>90</td></tr> </table>	W	X	7 W	95	13 W	115	18 W	125	GU10	90	<b>P7</b> 8.5W	<b>V9</b> 2700K / CRI 90 / 528 lm (M2)	<b>S1</b> 8°	<b>OU</b> ON-OFF 100-240V	<b>WP</b> <b>WS</b> <b>WQ</b>
	W	X													
	7 W	95													
	13 W	115													
	18 W	125													
	GU10	90													
<b>W9</b> 3000K / CRI 90 / 612 lm (M2)	<b>S2</b> 14°	<b>TS</b> PHASE CUT 220-240V													
<b>X9</b> 4000K / CRI 90 / 612 lm (M2)	<b>M2</b> 27°	<b>DS</b> DALI-2/PUSH 220-240V													
 <p><b>AG31 -</b> Cuadrado / Fijo / Sin marco Cuadrado / fixo / trimless 0-25 mm 75x75 IP54</p>  <table border="1"> <tr><th>W</th><th>X</th></tr> <tr><td>7 W</td><td>95</td></tr> <tr><td>13 W</td><td>115</td></tr> <tr><td>18 W</td><td>125</td></tr> <tr><td>GU10</td><td>90</td></tr> </table>	W	X	7 W	95	13 W	115	18 W	125	GU10	90	<b>13</b> 14.3W	<b>V9</b> 2700K / CRI 90 / 1131 lm (M2)	<b>S2</b> 19°	<b>OU</b> ON-OFF 100-240V	
	W	X													
	7 W	95													
	13 W	115													
	18 W	125													
	GU10	90													
<b>W9</b> 3000K / CRI 90 / 1218 lm (M2)	<b>M2</b> 33°	<b>TS</b> PHASE CUT 220-240V													
<b>X9</b> 4000K / CRI 90 / 1303 lm (M2)	<b>F1</b> 44°	<b>DS</b> DALI-2 220-240V													
 <p><b>AG31 -</b> Cuadrado / Fijo / Sin marco Cuadrado / fixo / trimless 0-25 mm 75x75 IP54</p>  <table border="1"> <tr><th>W</th><th>X</th></tr> <tr><td>7 W</td><td>95</td></tr> <tr><td>13 W</td><td>115</td></tr> <tr><td>18 W</td><td>125</td></tr> <tr><td>GU10</td><td>90</td></tr> </table>	W	X	7 W	95	13 W	115	18 W	125	GU10	90	<b>18</b> 19.8W	<b>V9</b> 2700K / CRI 90 / 1464 lm (M2)	<b>S2</b> 19°	<b>OU</b> ON-OFF 100-240V	
	W	X													
	7 W	95													
	13 W	115													
	18 W	125													
	GU10	90													
<b>W9</b> 3000K / CRI 90 / 1576 lm (M2)	<b>M2</b> 33°	<b>TS</b> PHASE CUT 220-240V													
<b>X9</b> 4000K / CRI 90 / 1686 lm (M2)	<b>F1</b> 46°	<b>DS</b> DALI-2 220-240V													
<b>AA</b> GU10W	<b>G1</b>	<b>NA</b>	<b>BU</b> 220-240V												

# Play Deco Double

IP  
23

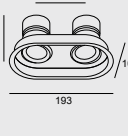

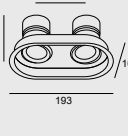

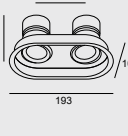

Ejemplo de código / Exemplo de código: **AG42-P7V9S10U14**







Model	W	K / CRI / Real lm	Optics	Source	Finishes										
 <p><b>AG42 -</b> Redondo / Ajustable Redondo / ajustável 2x 95x93 IP23 20+ -20° 320°</p>  <table border="1"> <tr><th>W</th><th>X</th></tr> <tr><td>7 W</td><td>95</td></tr> <tr><td>13 W</td><td>115</td></tr> <tr><td>18 W</td><td>135</td></tr> <tr><td>GU10</td><td>85</td></tr> </table>	W	X	7 W	95	13 W	115	18 W	135	GU10	85	<b>P7</b> 2 x 6.4W (12.8W)W	<b>V9</b> 2700K / CRI 90 / 1142 lm (M2)	<b>S1</b> 8°	<b>OU</b> ON-OFF 100-240V	<b>14</b> <b>23</b> <b>60</b>
	W	X													
	7 W	95													
	13 W	115													
	18 W	135													
	GU10	85													
	<b>W9</b> 3000K / CRI 90 / 1323 lm (M2)	<b>S2</b> 14°	<b>TS</b> PHASE CUT 220-240V												
	<b>X9</b> 4000K / CRI 90 / 1323 lm (M2)	<b>M2</b> 28°	<b>DS</b> DALI-2/PUSH 220-240V												
	 <p><b>AG42 -</b> Redondo / Ajustable Redondo / ajustável 2x 95x93 IP23 20+ -20° 320°</p>  <table border="1"> <tr><th>W</th><th>X</th></tr> <tr><td>7 W</td><td>95</td></tr> <tr><td>13 W</td><td>115</td></tr> <tr><td>18 W</td><td>135</td></tr> <tr><td>GU10</td><td>85</td></tr> </table>	W	X	7 W	95	13 W	115	18 W	135	GU10	85	<b>13</b> 2 x 11.9W (23.8W)W	<b>V9</b> 2700K / CRI 90 / 2443 lm (M2)	<b>S2</b> 19°	<b>OU</b> ON-OFF 100-240V
		W	X												
		7 W	95												
		13 W	115												
18 W		135													
GU10		85													
<b>W9</b> 3000K / CRI 90 / 2630 lm (M2)	<b>M2</b> 34°	<b>TS</b> PHASE CUT 220-240V													
<b>X9</b> 4000K / CRI 90 / 2814 lm (M2)	<b>F1</b> 45°	<b>DS</b> DALI-2 220-240V													
 <p><b>AG42 -</b> Redondo / Ajustable Redondo / ajustável 2x 95x93 IP23 20+ -20° 320°</p>  <table border="1"> <tr><th>W</th><th>X</th></tr> <tr><td>7 W</td><td>95</td></tr> <tr><td>13 W</td><td>115</td></tr> <tr><td>18 W</td><td>135</td></tr> <tr><td>GU10</td><td>85</td></tr> </table>	W	X	7 W	95	13 W	115	18 W	135	GU10	85	<b>18</b> 2 x 17.7W (34.4W)W	<b>V9</b> 2700K / CRI 90 / 3192 lm (M2)	<b>S2</b> 19°	<b>OU</b> ON-OFF 100-240V	
	W	X													
	7 W	95													
	13 W	115													
	18 W	135													
	GU10	85													
<b>W9</b> 3000K / CRI 90 / 3436 lm (M2)	<b>M2</b> 33°	<b>TS</b> PHASE CUT 220-240V													
<b>X9</b> 4000K / CRI 90 / 3676 lm (M2)	<b>F1</b> 47°	<b>DS</b> DALI-2 220-240V													
<b>AA</b> 2 x GU10W	<b>G1</b>	<b>NA</b>	<b>BU</b> 220-240V												

Play  
Mini 2WPlay  
Mini 3WPlay  
7WPlay  
13WPlay  
18WPlay  
GU10**Drivers**  
Driver



P. 1166

	ON-OFF IP20	71-8048-00-00	71-A662-00-00	71-B232-00-00	71-6652-00-00	71-6142-00-00	-
	PHASE CUT 240V IP20	71-4898-00-00	71-4898-00-00	71-7663-00-00	71-A297-00-00	71-4898-00-00	-
	1-10V PUSH IP20	71-7710-00-00	71-7710-00-00	71-7710-00-00	71-7710-00-00	71-7710-00-00	-
	DALI2 IP20	71-6192-00-00	71-6192-00-00	71-A190-00-00	71-B407-00-00	71-B407-00-00	-
	CASAMBI IP20	71-5961-00-00	71-5961-00-00	71-A261-00-00	71-A260-00-00	71-A260-00-00	-

**Accesorios ópticos**  
Acessórios óticos

	Difusor elíptico (5u.) Difusor elíptico (5u.)	71-7891-00-00	71-7891-00-00	71-5167-00-00	71-5167-00-00	71-5167-00-00	71-5167-00-00
	Difusor cuadrado (5u.) Difusor quadrado (5u.)	-	-	71-5658-00-00	71-5658-00-00	71-5658-00-00	71-5658-00-00
	Difuminador de halo (5u.) Difusor opalino (5u.)	71-7893-00-00	71-7893-00-00	71-6099-00-00	71-6099-00-00	71-6099-00-00	71-6099-00-00
	Panel de abeja (5u.) Painel de abelha (5u.)	71-7892-00-00	71-7892-00-00	71-5166-60-00	71-5166-60-00	71-5166-60-00	71-5166-60-00
	Apantallador (5u.) Obturador assimétrico (5u.)	71-7894-00-00	71-7894-00-00	71-7895-60-00	71-7895-60-00	71-7895-60-00	71-7895-60-00
	Conforto visual (1u.)	14 ○	-	71-4754-14-00	71-4754-14-00	71-4754-14-00	71-4754-14-00
	Conforto visual (1u.)	60 ●	-	71-4754-60-00	71-4754-60-00	71-4754-60-00	71-4754-60-00

**Accesorios de fijación**  
Acessórios de fixação

	Kit empotrado hormigón para Ø36 Kit encastrado betão para Ø36	71-5617-00-00	71-5617-00-00	-	-	-	-
	Kit empotrado hormigón para Ø40-42 Kit encastrado betão para Ø40-42	71-5618-00-00	71-5618-00-00	-	-	-	-

# Lite

Designed by LedsC4 Architectural



Con un diseño compacto y limpio, Lite es un downlight elegante que destaca por la calidad de su óptica y la resolución lumínica de su puesta de escena en cualquier espacio. Com um design compacto e limpo, Lite é um downlight elegante que se destaca pela qualidade da sua ótica e a resolução lumínica da sua encenação em qualquer espaço.



Módulo con carga de grafeno, más pequeño y ligero, que mejora su eficiencia y facilita la instalación en falsos techos con poca altura

Módulo mais pequeno e leve, com carga de grafeno, que melhora a eficiência e facilita a instalação em tetos falsos baixos





Bisel extra de fácil instalación  
 Bisel extra de instalação fácil

Bisel extra incluido, de uso opcional, permite extender el rango de instalación. Ideal para agujeros preexistentes desde Ø65 hasta Ø110mm.  
 Bisel extra incluído, para uso opcional, permite alargar a gama de instalação. Ideal para furos pré-existentes de Ø65 a Ø110mm.

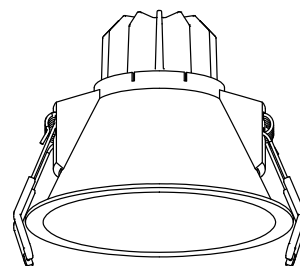
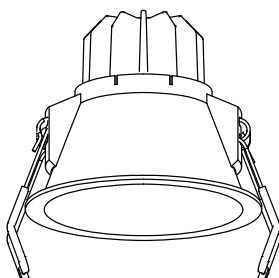
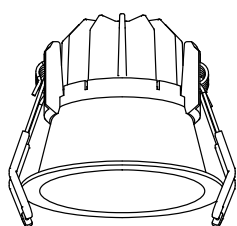

Ø 65-79 mm

Ø 80-94 mm

Ø 95-110 mm

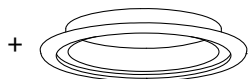

**Small**  
 Ø 75-89 mm

**Medium**  
 Ø 88-102 mm

**Large**  
 Ø 105-119 mm



Alto confort visual  
Alto conforto visual

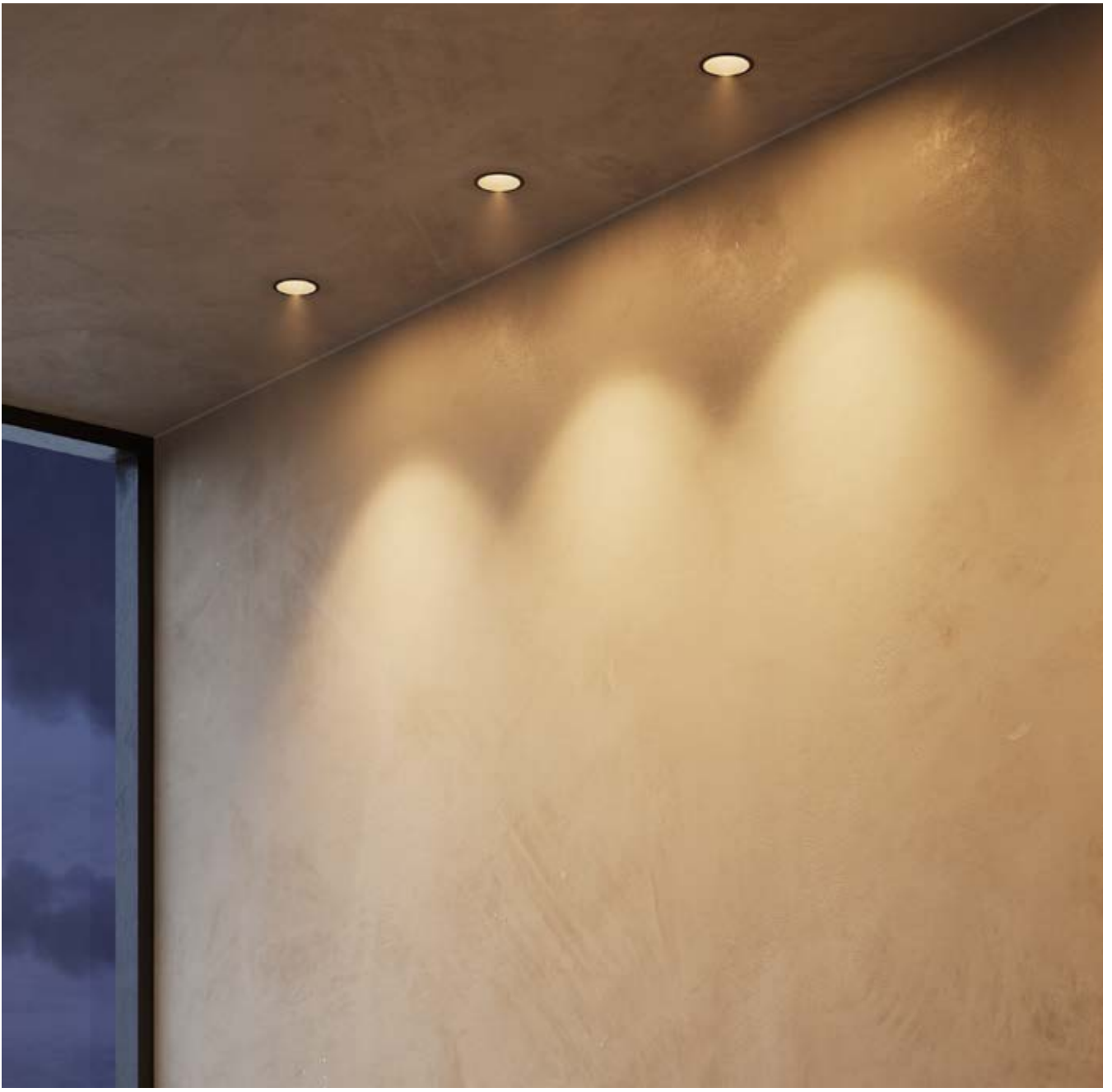

# Accesorios para modelar la luz

## Acessórios para moldar a luz

Los accesorios de Lite permiten modelar la luz y acondicionarla a las necesidades estéticas del espacio.

Os acessórios do Lite permitem modelar a luz e acondicioná-la às necessidades estéticas do espaço, oferecendo uma luz adaptável e de qualidade para cada situação.

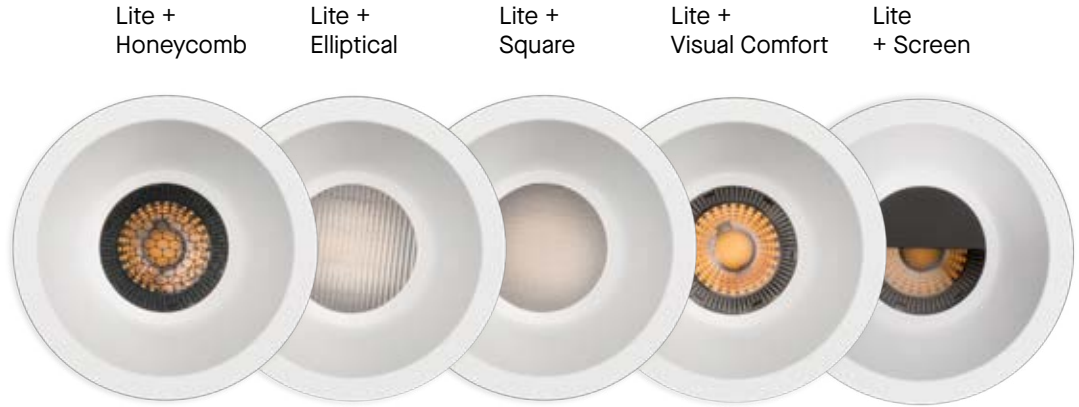

# Lite

BODY MAT	DIF MAT		50000h	3
PC,G	PC		L80 B20	MacAdam

## Lite 75mm

IP	UGR			
54	<19			

○ ●  
14 60

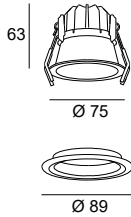
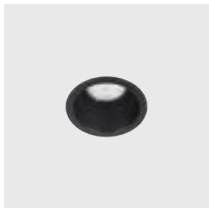

65-79 0-18 mm

LED									
K	CRI	W Total	Real Lm	Optics	Code				
2700	80	8.4	614	32°	<b>90-A026</b>	14	00	ON-OFF 100-240V	
						60	TS	PHASE CUT 220-240V	
3000	80	8.4	659	32°	<b>90-A027</b>	14	00	ON-OFF 100-240V	
						60	TS	PHASE CUT 220-240V	
4000	80	8.4	678	32°	<b>90-A028</b>	14	00	ON-OFF 100-240V	
						60	TS	PHASE CUT 220-240V	

## Lite 88mm

IP	UGR	
54	<19	

○ ●  
14 60

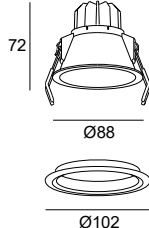

80-94 0-18 mm

LED									
K	CRI	W Total	Real Lm	Optics	Code				
2700	80	8.4	617	32°	<b>90-8078</b>	14	00	ON-OFF 100-240V	
						60	TS	PHASE CUT 220-240V	
3000	80	8.4	662	32°	<b>90-8079</b>	14	00	ON-OFF 100-240V	
						60	TS	PHASE CUT 220-240V	
4000	80	8.4	681	32°	<b>90-8080</b>	14	00	ON-OFF 100-240V	
						60	TS	PHASE CUT 220-240V	

## Lite 105mm

IP	UGR			
54	<16			

14 60

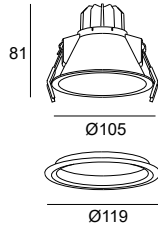

95-110 0-18 mm

LED									
K	CRI	W Total	Real	Lm	Optics	Code			
2700	80	8.4	595	30°	<b>90-A029</b>	- 14 - 00	ON-OFF 100-240V		
						- 60 - TS	PHASE CUT 220-240V		
3000	80	8.4	638	30°	<b>90-A030</b>	- 14 - 00	ON-OFF 100-240V		
						- 60 - TS	PHASE CUT 220-240V		
4000	80	8.4	656	30°	<b>90-A031</b>	- 14 - 00	ON-OFF 100-240V		
						- 60 - TS	PHASE CUT 220-240V		

### Lite 75mm

### Lite 88mm

### Lite 105mm

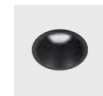

## Accesorios ópticos Acessórios óticos

	Difusor elíptico (5u.) Difusor elíptico (5u.)		<b>71-5167-00-00</b>	<b>71-5167-00-00</b>	<b>71-5167-00-00</b>
	Difusor cuadrado (5u.) Difusor quadrado (5u.)		<b>71-5658-00-00</b>	<b>71-5658-00-00</b>	<b>71-5658-00-00</b>
	Difuminador de halo (5u.) Difusor opalino (5u.)		<b>71-6099-00-00</b>	<b>71-6099-00-00</b>	<b>71-6099-00-00</b>
	Confort visual (1u.) Conforto visual (1u.)	14	<b>71-4754-14-00</b>	<b>71-4754-14-00</b>	<b>71-4754-14-00</b>
		60	<b>71-4754-60-00</b>	<b>71-4754-60-00</b>	<b>71-4754-60-00</b>
	Panel de abeja (5u.) Painel de abelha (5u.)	60	<b>71-5166-60-00</b>	<b>71-5166-60-00</b>	<b>71-5166-60-00</b>
	Apantallador (5u.) Obturador assimétrico (5u.)	60	<b>71-7895-60-00</b>	<b>71-7895-60-00</b>	<b>71-7895-60-00</b>

## Accesorios de fijación Acessórios de fixação

	Anillo extra para adaptar a diferentes diámetros Bisel extra para adaptar a diferentes diámetros	Included	Included	Included
--	-----------------------------------------------------------------------------------------------------	----------	----------	----------

# Dome



Downlight con bombilla GU10 para adaptarse de forma funcional y efectiva a cada necesidad.  
 Downlight com lâmpada GU10 para adaptar-se de forma funcional e efetiva a cada necessidade.

## Dome Ø90

BODY MAT		IP				
ST		23				

○ ●  
14 60

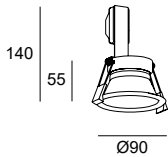

GU10

**W**

Max. 8

**Code**

**DN-1600 - 14 - 00**  
**60 - 00**

⌀ 82 0-25 mm

## Dome Ø120

BODY MAT		IP					
ST		23					±20°

○ ●  
14 60

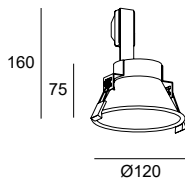

GU10

**W**

Max. 8

**Code**

**DN-1601 - 14 - 00**  
**60 - 00**

⌀ 112 0-25 mm

### Dome Ø90



### Dome Ø120



## Accesorios de fijación Acessórios de fixação



Anilla invisible para bombilla LED  
 Anilha invisível para lâmpada LED

Included

Included

# Ges Recessed



Downlights empotrados fabricados en yeso para facilitar la integración total de la luminaria en el espacio.

Downlights encastrados e de superfície fabricados em gesso para facilitar a integração total da luminária no espaço.

Fácil integración en pladur  
Integração fácil no pladur



**Instalación paso a paso.** Se recomienda el uso de un sellador flexible para evitar posibles fisuras y/o la acumulación de suciedad.

**Instalação passo a passo.** Recomenda-se o uso de um selante flexível para evitar possíveis fissuras e/ou acumulação de sujidade.

# Ges Recessed

BODY MAT  
PLSTER



## Ges Recessed Round Fix

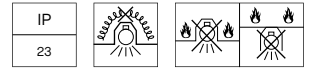

○  
14

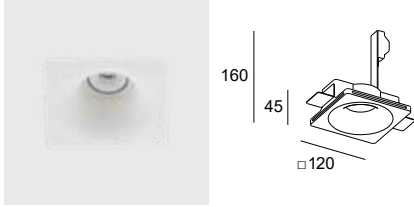

GU5.3	
<b>W</b> Max. 5	<b>Code</b> 90-2902 - 14 - 00

□ 125×125    ▬ 9-15 mm

## Ges Recessed Round Adjustable



○  
14

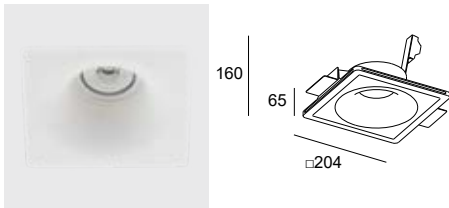

GU5.3	
<b>W</b> Max. 5	<b>Code</b> 90-2903 - 14 - 00

□ 210×210    ▬ 9-15 mm

## Ges Recessed Round Fix Deep

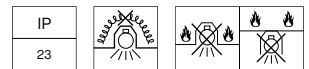

○  
14

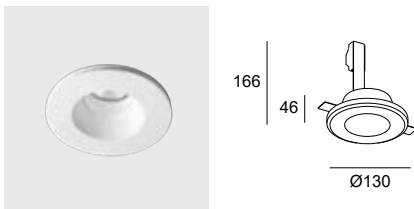



GU5.3	
<b>W</b> Max. 5	<b>Code</b> 90-1720 - 14 - 00

○ 135    ▬ 0-12 mm



**Ges Recessed Square Fix**

IP	  
23	

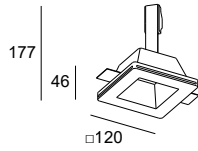

GU5.3	
<b>W</b>	<b>Code</b>
Max. 5	90-1722 - 14 - 00

125x125 0-12 mm

**Ges Recessed Round Fix**



**Ges Recessed Round Adjustable**



**Ges Recessed Round Fix Deep**



**Ges Recessed Square Fix**



**Accesorios de fijación**  
**Acessórios de fixação**



Accesorio para instalación de GU10 **71-4396-00-00**  
Acessório para instalação de GU10

**71-4396-00-00**

**71-4396-00-00**

**71-4396-00-00**

# Bento Standard

Designed by LedsC4 Architectural



De diseño estrecho y alargado, el empotrable de Bento está disponible en cuatro versiones lineales y una cuadrada. La estructura con módulos ópticos individuales, donde cada LED usa un reflector específico, está desarrollada para garantizar un máximo confort con efecto Dark Light.

De design estreito e alongado, o encastrável de Bento está disponível em quatro versões lineares e uma quadrada. A estrutura com módulos ópticos individuais, onde cada LED utiliza um refletor específico, é desenvolvida para garantir o máximo conforto com efeito Dark Light.





Versión cuadrada de Bento Standard Recessed. Ideal para iluminar de forma homogénea, con una integración máxima espacios como oficinas, despachos, zonas comunes de hoteles o salas de conferencias.

Versão quadrada do Bento Standard Recessed. Ideal para iluminar de forma homogénea, com uma integração máxima espaços como escritórios, zonas comuns de hotéis ou salas de conferências.

# Bento

## Recessed Standard

BODY MAT	3
AL	MacAdam

### Bento Standard 3 LEDS Trim

IP	UGR		50000h	WELL			
23	<13		L80 B20				

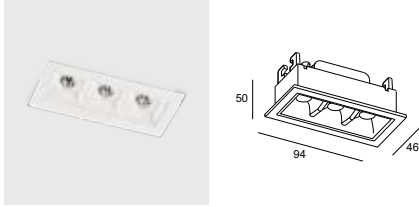

40x89 0-18 mm

LED							max.700mA 9V		
K	CRI	W	Real Lm	Optics	Code				
2700	90	6.1	560	18°	<b>90-6364</b>	14	14		
2700	90	6.1	638	38°	<b>90-6366</b>	60	60		
2700	90	6.1	603	47°	<b>90-6368</b>				
3000	90	6.1	560	18°	<b>90-6365</b>	14	14		
3000	90	6.1	638	38°	<b>90-6367</b>	60	60		
3000	90	6.1	603	47°	<b>90-6369</b>				
4000	90	6.1	609	18°	<b>90-6673</b>	14	14		
4000	90	6.1	693	38°	<b>90-6674</b>	60	60		
4000	90	6.1	655	47°	<b>90-6675</b>				

### Bento Standard 3 LEDS Trimless

IP	UGR		50000h	WELL				
23	<13		L80 B20					

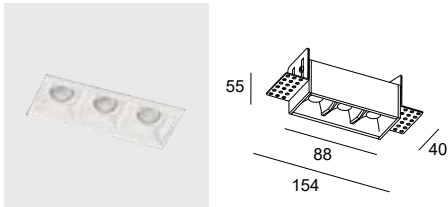

40x89 0-18 mm

LED							max.700mA 9V		
K	CRI	W	Real Lm	Optics	Code				
2700	90	6.1	560	18°	<b>90-6161</b>			60	
2700	90	6.1	638	38°	<b>90-6163</b>	14	14		
2700	90	6.1	603	47°	<b>90-6165</b>				
3000	90	6.1	560	18°	<b>90-6162</b>			60	
3000	90	6.1	638	38°	<b>90-6164</b>	14	14		
3000	90	6.1	603	47°	<b>90-6166</b>				
4000	90	6.1	609	18°	<b>90-6676</b>			60	
4000	90	6.1	693	38°	<b>90-6677</b>	14	14		
4000	90	6.1	655	47°	<b>90-6678</b>				

**Bento Standard 6 LEDs Trim**

IP 23	UGR <13		50000h L80 B20	WELL		
----------	------------	--	-------------------	------	--	--

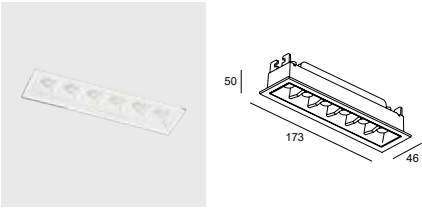

40x168 0-18 mm

LED							max.700mA 18V		
K	CRI	W	Real Lm	Optics	Code				
2700	90	12.2	1119	18°	<b>90-6370</b>				
2700	90	12.2	1276	38°	<b>90-6372</b>	- 14	- 14		
2700	90	12.2	1205	47°	<b>90-6374</b>	- 60	- 60		
3000	90	12.2	1119	18°	<b>90-6371</b>				
3000	90	12.2	1276	38°	<b>90-6373</b>	- 14	- 14		
3000	90	12.2	1205	47°	<b>90-6375</b>	- 60	- 60		
4000	90	12.2	1216	18°	<b>90-6679</b>				
4000	90	12.2	1387	38°	<b>90-6680</b>	- 14	- 14		
4000	90	12.2	1310	47°	<b>90-6681</b>	- 60	- 60		

**Bento Standard 6 LEDs Trimless**

IP 23	UGR <13		50000h L80 B20	WELL				
----------	------------	--	-------------------	------	--	--	--	--

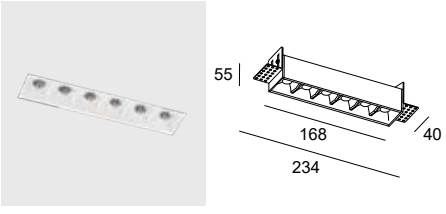

40x168 0-18 mm

LED							max.700mA 18V		
K	CRI	W	Real Lm	Optics	Code				
2700	90	12.2	1119	18°	<b>90-6167</b>				
2700	90	12.2	1276	38°	<b>90-6169</b>	- 14	- 14		
2700	90	12.2	1205	47°	<b>90-6171</b>	- 60	- 60		
3000	90	12.2	1119	18°	<b>90-6168</b>				
3000	90	12.2	1276	38°	<b>90-6170</b>	- 14	- 14		
3000	90	12.2	1205	47°	<b>90-6172</b>	- 60	- 60		
4000	90	12.2	1216	18°	<b>90-6682</b>				
4000	90	12.2	1387	38°	<b>90-6683</b>	- 14	- 14		
4000	90	12.2	1310	47°	<b>90-6684</b>	- 60	- 60		

**Bento Standard 12 LEDS Trim**

IP	UGR		50000h	WELL			
23	<16		L80 B20				

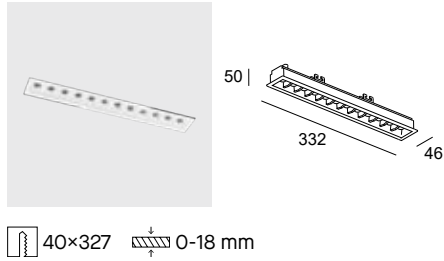

LED							max.700mA 36V		
K	CRI	W	Real Lm	Optics	Code				
2700	90	24.4	2240	18°	<b>90-6376</b>				
2700	90	24.4	2552	38°	<b>90-6378</b>	14	14		
2700	90	24.4	2412	47°	<b>90-6380</b>	60	60		
3000	90	24.4	2240	18°	<b>90-6377</b>				
3000	90	24.4	2552	38°	<b>90-6379</b>	14	14		
3000	90	24.4	2412	47°	<b>90-6381</b>	60	60		
4000	90	24.4	2435	18°	<b>90-6685</b>				
4000	90	24.4	2774	38°	<b>90-6686</b>	14	14		
4000	90	24.4	2622	47°	<b>90-6687</b>	60	60		

**Bento Standard 12 LEDS Trimless**

IP	UGR		50000h	WELL				
23	<16		L80 B20					

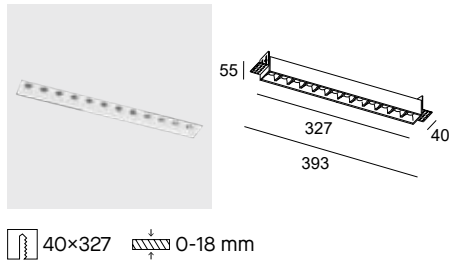

LED							max.700mA 36V		
K	CRI	W	Real Lm	Optics	Code				
2700	90	24.4	2240	18°	<b>90-6173</b>				
2700	90	24.4	2552	38°	<b>90-6175</b>	14	14		
2700	90	24.4	2412	47°	<b>90-6350</b>	60	60		
3000	90	24.4	2240	18°	<b>90-6174</b>				
3000	90	24.4	2552	38°	<b>90-6349</b>	14	14		
3000	90	24.4	2412	47°	<b>90-6351</b>	60	60		
4000	90	24.4	2435	18°	<b>90-6688</b>				
4000	90	24.4	2774	38°	<b>90-6689</b>	14	14		
4000	90	24.4	2622	47°	<b>90-6690</b>	60	60		

**Bento Standard 18 LEDS Trim**

IP	UGR		50000h	WELL			
23	<13		L80 B20				

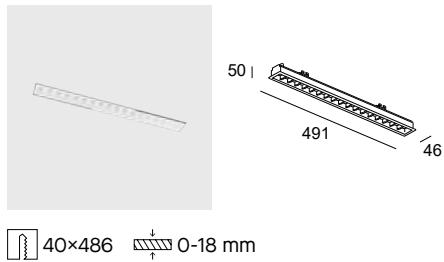

LED							max.700mA 54V		
K	CRI	W	Real Lm	Optics	Code				
2700	90	36.5	3360	18°	<b>90-6382</b>				
2700	90	36.5	3828	38°	<b>90-6384</b>	14	14		
2700	90	36.5	3618	47°	<b>90-6386</b>	60	60		
3000	90	36.5	3360	18°	<b>90-6383</b>				
3000	90	36.5	3828	38°	<b>90-6385</b>	14	14		
3000	90	36.5	3618	47°	<b>90-6387</b>	60	60		
4000	90	36.5	3652	18°	<b>90-6691</b>				
4000	90	36.5	4161	38°	<b>90-6692</b>	14	60		
4000	90	36.5	3933	47°	<b>90-6693</b>	60	14		

## Bento Standard 18 LEDs Trimless

IP 23	UGR <13		50000h L80 B20	WELL			
----------	------------	--	-------------------	------	--	--	--

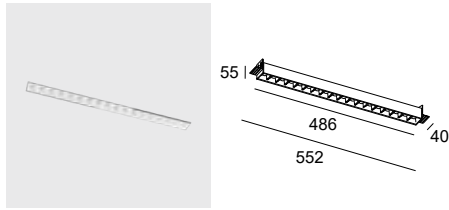

40x486 0-18 mm

LED							max.700mA 54V	
K	CRI	W	Real Lm	Optics	Code			
2700	90	36.5	3360	18°	<b>90-6352</b>			
2700	90	36.5	3828	38°	<b>90-6354</b>	- 14	-	<b>14 - 60</b>
2700	90	36.5	3618	47°	<b>90-6356</b>			
3000	90	36.5	3360	18°	<b>90-6353</b>			
3000	90	36.5	3828	38°	<b>90-6355</b>	- 14	-	<b>14 - 60</b>
3000	90	36.5	3618	47°	<b>90-6357</b>			
4000	90	36.5	3652	18°	<b>90-6694</b>			
4000	90	36.5	4161	38°	<b>90-6695</b>	- 14	-	<b>14 - 60</b>
4000	90	36.5	3933	47°	<b>90-6696</b>			

## Bento Standard Square Trim

IP 23	UGR <13		50000h L80 B20	WELL			
----------	------------	--	-------------------	------	--	--	--

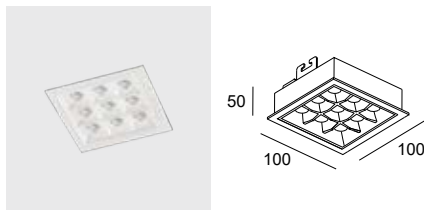

95x95 0-18 mm

LED							max.700mA 27V	
K	CRI	W	Real Lm	Optics	Code			
2700	90	18.3	1680	18°	<b>90-6388</b>			
2700	90	18.3	1914	38°	<b>90-6390</b>	- 14	-	<b>14 - 60</b>
2700	90	18.3	1809	47°	<b>90-6392</b>			
3000	90	18.3	1680	18°	<b>90-6389</b>			
3000	90	18.3	1914	38°	<b>90-6391</b>	- 14	-	<b>14 - 60</b>
3000	90	18.3	1809	47°	<b>90-6393</b>			
4000	90	18.3	1826	18°	<b>90-6697</b>			
4000	90	18.3	2080	38°	<b>90-6698</b>	- 14	-	<b>14 - 60</b>
4000	90	18.3	1966	47°	<b>90-6699</b>			

## Bento Standard Square Trimless

IP 23	UGR <13		50000h L80 B20	WELL				
----------	------------	--	-------------------	------	--	--	--	--

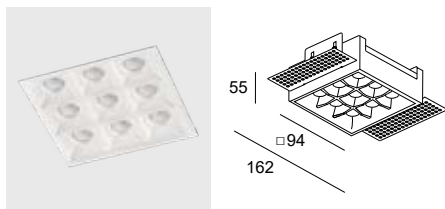

95x95 0-18 mm

LED							max.700mA 27V	
K	CRI	W	Real Lm	Optics	Code			
2700	90	18.3	1680	18°	<b>90-6358</b>			
2700	90	18.3	1914	38°	<b>90-6360</b>	- 14	-	<b>14 - 60</b>
2700	90	18.3	1809	47°	<b>90-6362</b>			
3000	90	18.3	1680	18°	<b>90-6359</b>			
3000	90	18.3	1914	38°	<b>90-6361</b>	- 14	-	<b>14 - 60</b>
3000	90	18.3	1809	47°	<b>90-6363</b>			
4000	90	18.3	1826	18°	<b>90-7002</b>			
4000	90	18.3	2080	38°	<b>90-7005</b>	- 14	-	<b>14 - 60</b>
4000	90	18.3	1966	47°	<b>90-7006</b>			



**Bento Standard Tunable White**

IP 23		LOW FLICKER	WELL				
----------	--	----------------	------	--	--	--	--

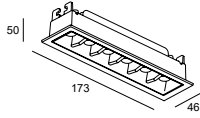
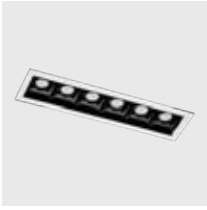

40x168 0-18 mm

K	CRI	Real Lm	Optics	Code	
TW 2700-6500	90	1169	38°	<b>90-7804</b>	<b>14</b>
TW 2700-6500	90	1042	48°	<b>90-7805</b>	<b>60</b>

DALI DT8 220-240V

<b>Bento Standard 3 LEDS Trim</b>	<b>Bento Standard 3 LEDS Trimless</b>	<b>Bento Standard 6 LEDS Trim</b>	<b>Bento Standard 6 LEDS Trimless</b>
---------------------------------------	-------------------------------------------	---------------------------------------	-------------------------------------------



**Drivers**  
Driver

P. 1166

	DALI D4i DALI2 IP20	-	-	-	<b>71-7737-00-00</b>
	CASAMBI IP20	-	-	<b>71-A261-00-00</b>	<b>71-A261-00-00</b>

<b>Bento Standard 12 LEDS Trim</b>	<b>Bento Standard 12 LEDS Trimless</b>	<b>Bento Standard 18 LEDS Trim</b>	<b>Bento Standard 18 LEDS Trimless</b>
----------------------------------------	--------------------------------------------	----------------------------------------	--------------------------------------------



**Drivers**  
Driver

P. 1166

	DALI D4i DALI2 IP20	<b>71-7738-00-00</b>	<b>71-7738-00-00</b>	-	-
	CASAMBI IP20	<b>71-A261-00-00</b>	<b>71-A261-00-00</b>	-	-

**Bento Standard  
Square Trim**

**Bento Standard  
Square Trimless**

**Bento Standard  
Tunable White**



**Drivers  
Driver**

P. 1166



DALI D4i  
DALI2  
IP20

**71-7737-00-00**

**71-7737-00-00**

-



CASAMBI  
IP20

**71-A261-00-00**

**71-A261-00-00**

**71-5961-00-00**

# Bento Adjustable

Designed by LedsC4 Architectural



La versión ajustable de Bento permite el movimiento de la estructura interior, ofreciendo la posibilidad de ajustar el haz de luz.

A versão ajustável de Bento permite o movimento da estrutura interior, oferecendo a possibilidade de ajustar o feixe de luz.



# Bento

## Recessed Adjustable

BODY MAT	3
AL	MacAdam

INDOOR

### Bento Adjustable 3 LEDs

IP	UGR		50000h	WELL			
23	<13		L80 B20				

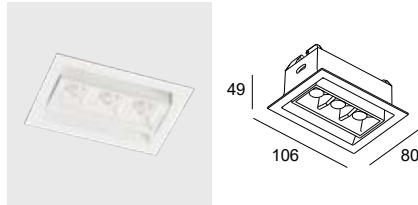

96×70 0-20 mm

LED						max.700mA 9V	
K	CRI	W	Real Lm	Optics	Code		
2700	90	6.1	560	18°	90-7098	14	14
2700	90	6.1	638	38°	90-7099	60	60
2700	90	6.1	603	47°	90-7100	60	60
3000	90	6.1	560	18°	90-7101	14	14
3000	90	6.1	638	38°	90-7161	60	60
3000	90	6.1	603	47°	90-7169	60	60
4000	90	6.1	609	18°	90-7184	14	14
4000	90	6.1	693	38°	90-7185	60	60
4000	90	6.1	655	47°	90-7186	60	60

### Bento Adjustable 6 LEDs

IP	UGR		50000h	WELL			
23	<13		L80 B20				

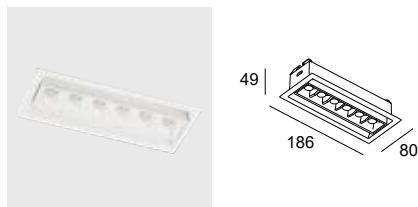

175×70 0-20 mm

LED						max.700mA 18V	
K	CRI	W	Real Lm	Optics	Code		
2700	90	12.2	1119	18°	90-7187	14	14
2700	90	12.2	1276	38°	90-7188	60	60
2700	90	12.2	1205	47°	90-7189	60	60
3000	90	12.2	1119	18°	90-7190	14	14
3000	90	12.2	1276	38°	90-7191	60	60
3000	90	12.2	1205	47°	90-7192	60	60
4000	90	12.2	1216	18°	90-7193	14	14
4000	90	12.2	1387	38°	90-7194	60	60
4000	90	12.2	1310	47°	90-7195	60	60

#### Bento Adjustable 3 LEDs

#### Bento Adjustable 6 LEDs



### Drivers

P. 1166



DALI D4i  
DALI2  
IP20

-

71-7737-00-00



CASAMBI  
IP20

71-A261-00-00

71-A261-00-00

# Bento Recessed IP

Designed by LedsC4 Architectural



Con una protección IP65, Bento IP recessed puede instalarse en ambientes donde haya humedad o exposición al polvo y al agua, sin prescindir de todas las prestaciones de la colección Bento.

Com proteção IP65, Bento IP recessed pode ser instalado em ambientes onde haja humidade ou exposição ao pó e à água, sem prescindir de todas as características da coleção Bento.

## Protección IP65

## Proteção IP65

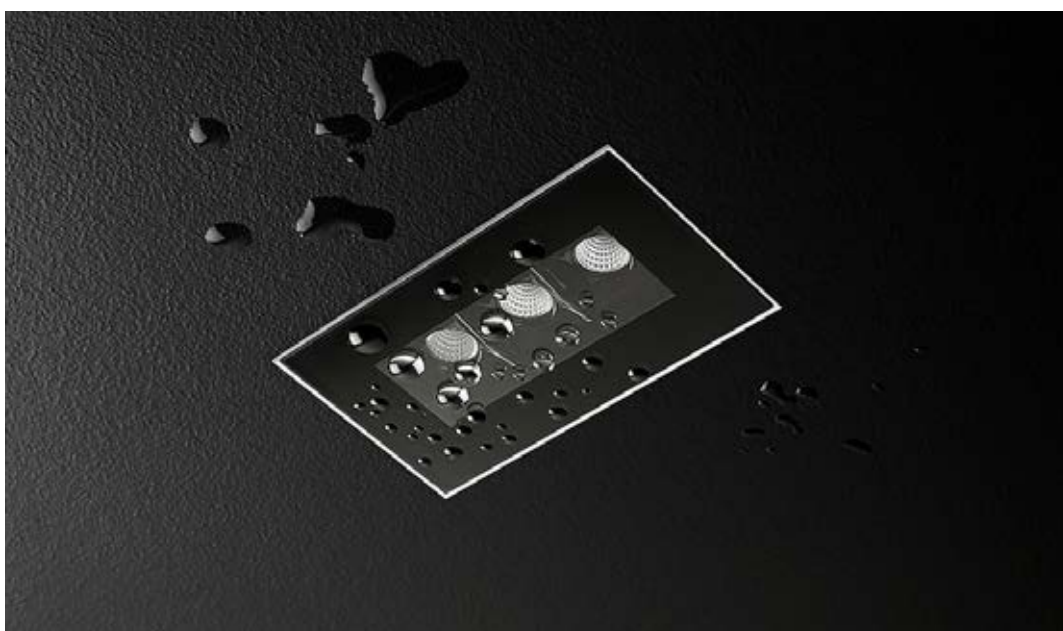

### Bento IP 3 LEDS

IP	UGR	DIF MAT		50000h	WELL			
65	<13	GLA		L80 B20				

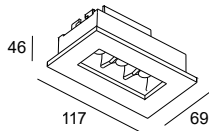

59x107 0-20 mm

LED						max.700mA 9V
K	CRI	W	Real Lm	Optics	Code	
2700	90	6.1	560	18°	<b>90-7214</b>	
2700	90	6.1	638	38°	<b>90-7215</b>	- 14 - 60
2700	90	6.1	603	47°	<b>90-7216</b>	
3000	90	6.1	560	18°	<b>90-7217</b>	
3000	90	6.1	638	38°	<b>90-7218</b>	- 14 - 60
3000	90	6.1	603	47°	<b>90-7219</b>	
4000	90	6.1	609	18°	<b>90-7220</b>	
4000	90	6.1	693	38°	<b>90-7221</b>	- 14 - 60
4000	90	6.1	655	47°	<b>90-7222</b>	

### Bento IP 6 LEDS

IP	DIF MAT	UGR		50000h	WELL			
65	GLA	<13		L80 B20				

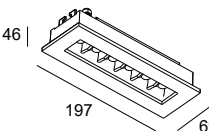

59x187 0-20 mm

LED						max.700mA 18V
K	CRI	W	Real Lm	Optics	Code	
2700	90	12.2	1119	18°	<b>90-7223</b>	
2700	90	12.2	1276	38°	<b>90-7224</b>	- 14 - 60
2700	90	12.2	1205	47°	<b>90-7225</b>	
3000	90	12.2	1119	18°	<b>90-7226</b>	
3000	90	12.2	1276	38°	<b>90-7227</b>	- 14 - 60
3000	90	12.2	1205	47°	<b>90-7228</b>	
4000	90	12.2	1216	18°	<b>90-7229</b>	
4000	90	12.2	1387	38°	<b>90-7230</b>	- 14 - 60
4000	90	12.2	1310	47°	<b>90-7231</b>	

#### Bento IP 3 LEDS

#### Bento IP 6 LEDS



### Drivers

Driver

P. 1166



DALI D4i  
DALI2  
IP20

71-7737-00-00

### Accesorios de fijación

Acessórios de fixação



Kit instalación trimless  
Kit instalação trimless

14 71-7522-14-00

# Bento Wall Washer

Designed by LedsC4 Architectural



Gracias a los nuevos reflectores en forma de cuchara micrograbados, Bento Wall Washer genera un bañado de pared homogéneo y sin sombras, a la vez que proporciona al ambiente un apantallamiento, logrando así mantener el efecto dark light característico de toda la familia Bento.

Graças aos novos refletores em forma de colher microgravada, Bento Wall Washer cria um washlight de parede homogéneo e sem sombras, ao mesmo tempo que proporciona ao ambiente uma blindagem, conseguindo assim manter o efeito dark light característico de toda a família Bento.



Reflectores en forma de  
cuchara micrograbados  
Refletores em forma de  
colher microgravada





Pantalla longitudinal para efecto Dark Light y bañado homogéneo.  
Quebra-luz longitudinal para efeito Dark Light e washlight homogéneo.



INDOOR

DOWNLIGHTS

# Bento

## Wall Washer

BODY MAT	3
AL	MacAdam

### Bento Wallwasher 3 LEDs Trim

NEW
IP 20
UGR <10
50000h L80 B20
RECYCLED ALUMINUM
LED

○ ●  
14 60

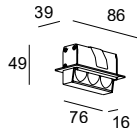

28x76 25 mm

LED						max.350mA 9V	
K	CRI	W	Real Lm	Code			
2700	90	3	207	90-A112	14	60	- 00
3000	90	3	230	90-A113	14	60	- 00
4000	90	3	276	90-A114	14	60	- 00

### Bento Wallwasher 3 LEDs Trimless

NEW
IP 20
UGR <10
50000h L80 B20
RECYCLED ALUMINUM
LED

○ ●  
14 60

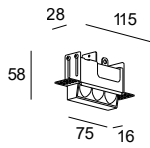

28x75 25 mm

LED						max.350mA 9V	
K	CRI	W	Real Lm	Code			
2700	90	3	207	90-A115	14	60	- 00
3000	90	3	230	90-A116	14	60	- 00
4000	90	3	276	90-A117	14	60	- 00

### Bento Wallwasher 6 LEDs Trim

NEW
IP 20
UGR <10
50000h L80 B20
RECYCLED ALUMINUM
LED

○ ●  
14 60

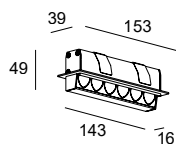
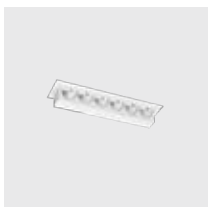

28x143 25 mm

LED						max.350mA 18V	
K	CRI	W	Real Lm	Code			
2700	90	6	421	90-A118	14	60	- 00
3000	90	6	468	90-A119	14	60	- 00
4000	90	6	562	90-A120	14	60	- 00

**Bento Wallwasher 6 LEDs  
Trimless**

NEW IP 20 UGR <10 50000h L80 B20

14 60

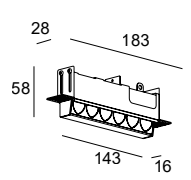
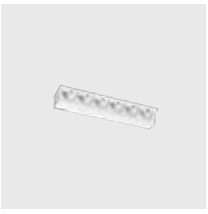

28x143 25 mm

LED max.350mA 18V

K	CRI	W	Real Lm	Code
2700	90	6	421	90-A121 - 14 - 60 - 00
3000	90	6	468	90-A122 - 14 - 60 - 00
4000	90	6	562	90-A123 - 14 - 60 - 00

**Bento Wallwasher 12 LEDs Trim**

NEW IP 20 UGR <10 50000h L80 B20

14 60

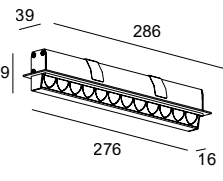
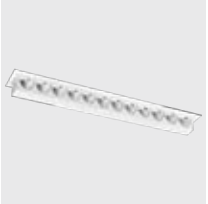

28x276 25 mm

LED max.350mA 36V

K	CRI	W	Real Lm	Code
2700	90	12	842	90-A124 - 14 - 60 - 00
3000	90	12	936	90-A125 - 14 - 60 - 00
4000	90	12	1123	90-A126 - 14 - 60 - 00

**Bento Wallwasher 12 LEDs  
Trimless**

NEW IP 20 UGR <10 50000h L80 B20

14 60

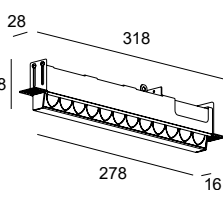

28x278 25 mm

LED max.350mA 36V

K	CRI	W	Real Lm	Code
2700	90	12	842	90-A127 - 14 - 60 - 00
3000	90	12	936	90-A128 - 14 - 60 - 00
4000	90	12	1123	90-A129 - 14 - 60 - 00

---

# Luno Recessed

---



Luno recessed es un downlight de forma cilíndrica y líneas puras. Solución con una gran eficiencia, es una opción ideal para iluminar grandes espacios como auditorios, salas de conferencias, restaurantes o vestíbulos de hoteles.

Luno recessed é um downlight básico de forma cilíndrica e formas puras. Uma solução altamente eficiente, é a escolha ideal para iluminar grandes espaços como auditórios, salas de conferências, restaurantes ou lobbies de hotel.

BODY MAT	DIF MAT		50000h	3
AL	PMMA		L80 B20	MacAdam

## Luno Recessed Ø400

IP	UGR	WELL			
20	<22				

○ ● ●  
14 60 DL\*

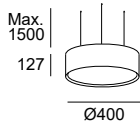

400

LED						
K	CRI	W Total	Real Lm	Code	DL	OU - RU
3000	80	27.5	2389	<b>90-5922</b>	- 14 - 60	ON-OFF 100-240V 1-10V 100-240V
4000	80	27.5	2389	<b>90-5923</b>	- 14 - 60	ON-OFF 100-240V 1-10V 100-240V

## Luno Recessed Ø1200

IP	WELL			
20				

○ ● ●  
14 60 DL\*

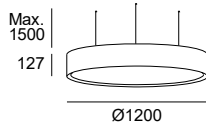

1200

LED						
K	CRI	W Total	Real Lm	Code	DL	OU - RU
3000	80	161.3	15065	<b>90-5928</b>	- 14 - 60	ON-OFF 100-240V 0-10V 100-240V
4000	80	161.3	15065	<b>90-5929</b>	- 14 - 60	ON-OFF 100-240V 0-10V 100-240V

# Multidir Evo Recessed

Designed by LedsC4 Architectural



+  
Multidir Evo  
Recessed



Multidir Evo Recessed se presenta con una óptica individual y doble en distintos acabados y con opciones Trim y Trimless. Su sistema cardánico, rediseñado y mejorado, es una opción ideal para ambientes retail, tanto en la versión LED como GU10.

Multidir Evo Recessed está disponível com ótica individual e dupla em diferentes acabamentos e com opções Trim y trimless. O seu sistema cardã redesenhado e melhorado, é a opção ideal para ambientes retail, tanto na versão LED como GU10.

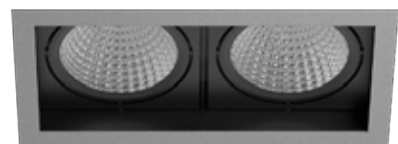







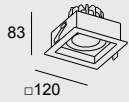

BODY MAT	DIF MAT	50000h	2
AL	PC	L80 B20	MacAdam

## Multidir Evo Multidir Small Single Downlight

IP		
54	40°	40°

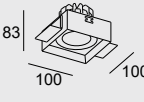
Ejemplo de código / Exemplo de código: **AU11-P8V9S3OS60**

Model	W	K / CRI / Real lm	Optics	Source	Finishes
<b>AU11 -</b> Simple / Empotrada / Con Marco Simples / encastrada / com aro 0-20 mm 110x110 IP54  	 <b>P8</b> 7.6W	<b>V9</b> 2700K / CRI90 / 863 lm	<b>S3</b> 17°	<b>OS</b> ON-OFF 220-240V	<b>60</b>  <b>14</b>  <b>34</b> 
		<b>W9</b> 3000K / CRI90 / 860 lm	<b>M3</b> 24°	<b>DS</b> DALI-2 110-277V	
		<b>X9</b> 4000K / CRI90 / 854 lm	<b>F1</b> 64°	<b>BB</b> 30V/max.250mA	
<b>AU12 -</b> Simple / Empotrada / Sin Marco Simples / Encastrado / Sem aro 0-20 mm 100x100 IP54  	 <b>11</b> 11.7W	<b>V9</b> 2700K / CRI90 / 1087 lm	<b>S3</b> 18°	<b>OU</b> ON-OFF 100-240V	
		<b>W9</b> 3000K / CRI90 / 1144 lm	<b>M3</b> 25°	<b>DS</b> DALI-2 110-277V	
		<b>X9</b> 4000K / CRI90 / 1141 lm	<b>F1</b> 64°	<b>BB</b> 30V/max.350mA	
<b>AA</b> GU10W	<b>G1</b>	<b>NA</b>	<b>BU</b> 100-240V		











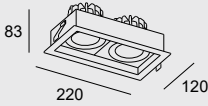



## Multidir Evo

### Multidir Small Double Downlight

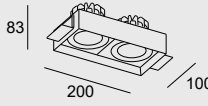
IP		
54		40°

Ejemplo de código / Exemplo de código: **AU13-P8V9S3OS60**

Model	W	K / CRI / Real lm	Optics	Source	Finishes
<b>AU13 -</b> Doble / Empotrada / Con Marco Duplo / encastrada / com aro 0-20 mm 208x110 IP54  	<b>P8</b> 2 x 7,6W	<b>V9</b> 2700K / CRI90 / 1739 lm	<b>S3</b> 17°	<b>OS</b>  ON-OFF 220-240V	<b>60</b>  <b>14</b>  <b>34</b> 
		<b>W9</b> 3000K / CRI90 / 1721 lm	<b>M3</b> 24°	<b>DS</b>  DALI-2 110-277V	
		<b>X9</b> 4000K / CRI90 / 1708 lm	<b>F1</b> 64°	<b>BB</b>  30V/max.250mA	
<b>AU14 -</b> Doble / Empotrada / Sin Marco DUPLO / Encastrado / Sem Aro 0-20 mm 200x100 IP54  	<b>11</b> 2 x 11.7W	<b>V9</b> 2700K / CRI90 / 2288 lm	<b>S3</b> 18°	<b>OU</b>  ON-OFF 100-240V	
		<b>W9</b> 3000K / CRI90 / 2282 lm	<b>M3</b> 25°	<b>DS</b>  DALI-2 110-277V	
		<b>X9</b> 4000K / CRI90 / 2282 lm	<b>F1</b> 64°	<b>BB</b>  30V/max.350mA	
<b>AA</b> 2 x GU10	<b>G1</b>	<b>NA</b>	<b>BU</b>  100-240V		

Multidir Evo Big Double Downlight	Multidir Evo Big Double Downlight GU10	Multidir Evo Big Single Downlight GU10	Multidir Evo Big Single Downlight 39W
FALTA IMAGEN			

**Drivers**  
Driver

P. 1166

	ON-OFF IP20	<b>71-3542-00-00</b>	-	-	<b>71-6661-00-00</b>
	PHASE CUT 240V IP20	-	-	-	-
	1-10V PUSH IP20	<b>71-4708-00-00</b>	-	-	<b>71-4708-00-00</b>
	1-10V DALI2 PUSH IP20	<b>71-4706-00-00</b>	-	-	-
	DALI2 IP20	-	-	-	-
	DALI2 PUSH IP20	-	-	-	<b>71-A303-00-00</b>
	CASAMBI IP20	-	-	-	<b>71-A260-00-00</b>











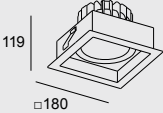





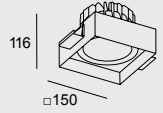

**Accesorios ópticos**  
Acessórios óticos

	Panel de abeja (5u.) Painel de abelha (5u.)	60 ●	<b>71-A855-60-00</b>	<b>71-A855-60-00</b>	<b>71-A855-60-00</b>	<b>71-A855-60-00</b>
--	------------------------------------------------	------	----------------------	----------------------	----------------------	----------------------

**Multidir Evo**  
**Multidir Big Single Downlight**

IP		
54		40°

Ejemplo de código / Exemplo de código: **AU17-18V9S30U60**

Model	W	K / CRI / Real lm	Optics	Source	Finishes
<b>AU17 -</b> Simple / Empotrado / Con Marco Simples / Encastrado / Com aro ≡ 0-20 mm □ 160×160  	<b>18</b> 18.2W	<b>V9</b> 2700K / CRI90 / 1993 lm	<b>S3</b> 15°	<b>OU</b>  ON-OFF 100-240V	<b>60</b>  <b>14</b>  <b>34</b> 
		<b>W9</b> 3000K / CRI90 / 1971 lm	<b>M3</b> 23°	<b>DS</b>  DALI-2 110-277V	
		<b>X9</b> 4000K / CRI90 / 2011 lm	<b>F1</b> 63°	<b>BB</b>  33V/max.500mA	
<b>AU18 -</b> Simple / Empotrada / Sin Marco Simples / Encastrado / Sem aro ≡ 0-20 mm □ 150×150  	<b>25</b> 25.4W	<b>V9</b> 2700K / CRI90 / 2715 lm	<b>S3</b> 14°	<b>OU</b>  ON-OFF 100-240V	
		<b>W9</b> 3000K / CRI90 / 2735 lm	<b>M3</b> 23°	<b>DS</b>  DALI-2 110-277V	
		<b>X9</b> 4000K / CRI90 / 2696 lm	<b>F1</b> 63°	<b>BB</b>  33V/max.700mA	
	<b>33</b> 33.3W	<b>V9</b> 2700K / CRI90 / 3409 lm	<b>S3</b> 14°	<b>OS</b>  ON-OFF 220-240V	
		<b>W9</b> 3000K / CRI90 / 3439 lm	<b>M3</b> 23°	<b>DS</b>  DALI-2 110-277V	
		<b>X9</b> 4000K / CRI90 / 3375 lm	<b>F1</b> 63°	<b>BB</b>  33V/max.900mA	
	<b>39</b> 37.5W	<b>V9</b> 2700K / CRI90 / 3891 lm	<b>S3</b> 15°	<b>OU</b>  ON-OFF 100-240V	
		<b>W9</b> 3000K / CRI90 / 3968 lm	<b>M3</b> 23°	<b>DS</b>  DALI-2/PUSH 220-240V	
		<b>X9</b> 4000K / CRI90 / 3878 lm	<b>F1</b> 63°	<b>BB</b>  33V/max.1050mA	
	<b>AA</b> GU10W	<b>G1</b>	<b>NA</b>	<b>BU</b>  100-240V	













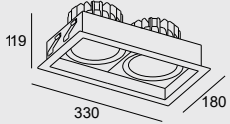





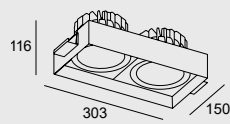

**Multidir Evo**  
**Multidir Big Double Downlight**

IP		
54		40°

Ejemplo de código / Exemplo de código: **AU19-18V9S3OU60**

INDOOR

DOWNLIGHTS

Model	W	K / CRI / Real lm	Optics	Source	Finishes	
<b>AU19 -</b> Doble / Empotrada / Con Marco Duplo / encastrada / com aro 0-20 mm  310x160  	<b>18</b> 2 × 18.2W	<b>V9</b> 2700K / CRI90 / 4017 lm	<b>S3</b> 15°	<b>OU</b>  ON-OFF 100-240V	<b>60</b>  <b>14</b>  <b>34</b> 	
		<b>W9</b> 3000K / CRI90 / 3943 lm	<b>M3</b> 23°	<b>DS</b>  DALI-2 110-277V		
		<b>X9</b> 4000K / CRI90 / 4022 lm	<b>F1</b> 63°	<b>BB</b>  33V/max.500mA		
	<b>AU21 -</b> Doble / Empotrada / Sin Marco DUPLO / Encastrado / Sem Aro 0-20 mm  305x150  	<b>25</b> 2 × 25.4W	<b>V9</b> 2700K / CRI90 / 5469 lm	<b>S3</b> 14°	<b>OU</b>  ON-OFF 100-240V	
			<b>W9</b> 3000K / CRI90 / 5470 lm	<b>M3</b> 23°	<b>DS</b>  DALI-2 110-277V	
			<b>X9</b> 4000K / CRI90 / 5391 lm	<b>F1</b> 63°	<b>BB</b>  33V/max.700mA	
<b>33</b> 2 × 33.3W		<b>V9</b> 2700K / CRI90 / 6867 lm	<b>S3</b> 14°	<b>OS</b>  ON-OFF 220-240V		
		<b>W9</b> 3000K / CRI90 / 6877 lm	<b>M3</b> 23°	<b>DS</b>  DALI-2 110-277V		
		<b>X9</b> 4000K / CRI90 / 6750 lm	<b>F1</b> 63°	<b>BB</b>  33V/max.900mA		
<b>39</b> 2 × 37.5W	<b>V9</b> 2700K / CRI90 / 7838 lm	<b>S3</b> 15°	<b>OU</b>  ON-OFF 100-240V			
	<b>W9</b> 3000K / CRI90 / 7936 lm	<b>M3</b> 23°	<b>DS</b>  DALI-2/PUSH 220-240V			
	<b>X9</b> 4000K / CRI90 / 7756 lm	<b>F1</b> 63°	<b>BB</b>  33V/max.1050mA			
<b>AA</b> 2 x GU10		<b>G1</b>	<b>NA</b>	<b>BU</b>  100-240V		

Multidir Evo  
Big Single  
Downlight  
33W



Multidir Evo  
Big Single  
Downlight  
25W



Multidir Evo  
Big Single  
Downlight 18W



Multidir Evo  
Small Double  
Downlight  
GU10



## Drivers Driver

P. 1166



ON-OFF  
IP20

71-3542-00-00

71-6653-00-00

71-6142-00-00

-



PHASE CUT 240V  
IP20

-

71-A299-00-00

71-4898-00-00

-



1-10V  
PUSH  
IP20

71-4708-00-00

71-4708-00-00

71-7710-00-00

-



1-10V  
DALI2  
PUSH  
IP20

-

-

-

-



DALI2  
IP20

-

-

71-B407-00-00

-



DALI2  
PUSH  
IP20

71-A303-00-00

71-A192-00-00

-

-



CASAMBI  
IP20

71-A260-00-00

71-A260-00-00

71-A260-00-00

-

## Accesorios ópticos Acessórios óticos







Panel de abeja (5u.)  
Painel de abelha (5u.)

71-A855-60-00

71-A855-60-00







71-A855-60-00

71-A854-60-00

Multidir Evo Small Double Downlight	Multidir Evo Small Single Downlight 8W	Multidir Evo Small Single Downlight 11W	Multidir Evo Small Single Downlight GU10
			

**Drivers**  
Driver

P. 1166

	ON-OFF IP20	<b>71-3542-00-00</b>	-	<b>71-6652-00-00</b>	-
	PHASE CUT 240V IP20	-	-	<b>71-A297-00-00</b>	-
	1-10V PUSH IP20	<b>71-4708-00-00</b>	-	<b>71-7710-00-00</b>	-
	1-10V DALI2 PUSH IP20	<b>71-4706-00-00</b>	-	-	-
	DALI2 IP20	-	<b>71-B407-00-00</b>	<b>71-B407-00-00</b>	-
	DALI2 PUSH IP20	-	-	-	-
	CASAMBI IP20	-	-	<b>71-A260-00-00</b>	-

**Accesorios ópticos**  
Acessórios óticos

	Panel de abeja (5u.) Painel de abelha (5u.)	<b>71-A854-60-00</b>	<b>71-A854-60-00</b>	<b>71-A854-60-00</b>	<b>71-A854-60-00</b>
-------------------------------------------------------------------------------------	------------------------------------------------	----------------------	----------------------	----------------------	----------------------

# Totem



+ Totem



La iluminación no debe restar protagonismo al diseño del espacio, se debe de integrar en él sin sacrificar la calidad lumínica y acentuando correctamente los productos expuestos. Totem presenta un ángulo de inclinación de hasta 30°, lo que evita destellos en el marco de la luminaria consiguiendo así un efecto limpio y comfortable.

A iluminação não deve tirar protagonismo ao design do espaço, deve ser integrada no mesmo sem sacrificar a qualidade lumínica e acentuar corretamente os produtos expostos. Totem tem um ângulo de inclinação de até 30°, o que evita cintilação no aro da luminária, conseguindo assim um efeito limpo e confortável.

Ángulo de inclinación de  
la óptica hasta 30°  
Ângulo de inclinação  
da ótica até 30°







Iluminación de acento. En el ámbito retail, Totem consigue dirigir la atención del consumidor a la zona requerida.  
Iluminação de realce. No setor do retail, Totem consegue dirigir a atenção do consumidor para a zona requerida.



Eficiencia de 100 ml / W.  
Eficiência de 100 ml / W.

Leds personalizables con distintos espectros para realzar productos según necesidades  
Leds personalizáveis com espectros diferentes para melhorar os produtos de acordo com as necessidades



A. Iluminación standard / Iluminação standard  
B. Iluminación Totem / Iluminação Totem

BODY MAT	DIF MAT		50000h	2
AL	PC		L80 B20	MacAdam

## Totem Simple Ø55

○ ●  
H2 G7

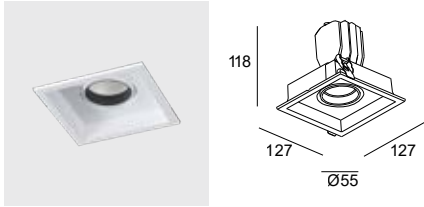

114x114 0-15 mm

LED									
K	CRI	W Total	Real Lm	Optics	Code				
3000	90	25	2272	15	<b>90-A054</b>	H2	OS	ON-OFF 220-240V	
3000	90	25	2250	24	<b>90-A055</b>	G7	DS	DALI 220-240V	
3000	90	25	2227	38	<b>90-A056</b>				
3500	90	25	2297	15	<b>90-A057</b>	H2	OS	ON-OFF 220-240V	
3500	90	25	2275	24	<b>90-A058</b>	G7	DS	DALI 220-240V	
3500	90	25	2252	38	<b>90-A059</b>				
4000	90	25	2362	15	<b>90-A091</b>	H2	OS	ON-OFF 220-240V	
4000	90	25	2339	24	<b>90-A092</b>	G7	DS	DALI 220-240V	
4000	90	25	2315	38	<b>90-A093</b>				

Totem Simple Ø55      Totem Simple Ø80      Totem Double Ø55      Totem Double Ø80      Totem Triplex Ø55



## Controladores

P. 1166

	CASAMBI IP20	<b>71-5961-00-00</b>	<b>71-5961-00-00</b>	-	-	-
	Falta info driver	-	-	<b>71-A301-00-00</b>	<b>71-A301-00-00</b>	<b>71-A301-00-00</b>

## Totem Simple Ø80

○ ●  
H2 G7

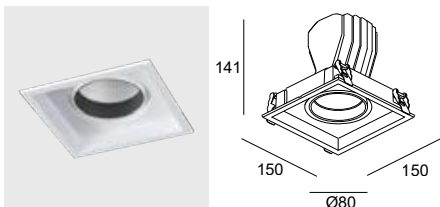

137x137 0-15 mm

LED									
K	CRI	W Total	Real Lm	Optics	Code				
3000	90	34	3280	38	<b>90-A045</b>	H2	OS	ON-OFF 220-240V	
3000	90	34	3217	55	<b>90-A046</b>	G7	DS	DALI 220-240V	
3000	90	34	3375	24	<b>90-A053</b>				
3500	90	34	3489	24	<b>90-A047</b>	H2	OS	ON-OFF 220-240V	
3500	90	34	3468	38	<b>90-A048</b>	G7	DS	DALI 220-240V	
3500	90	34	3326	55	<b>90-A049</b>				
4000	90	34	3602	24	<b>90-A050</b>	H2	OS	ON-OFF 220-240V	
4000	90	34	3656	38	<b>90-A051</b>	G7	DS	DALI 220-240V	
4000	90	34	3436	55	<b>90-A052</b>				

## Totem Simple Ø80 Bread / Fish / Meat

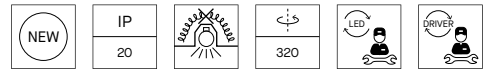

○ ●  
H2 G7

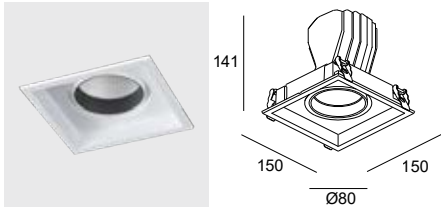

137×137 0-15 mm

LED							
K	W Total	Real Lm	Optics	Code			
Bread	34	2937	38	<b>90-A090</b> - <b>H2</b> - <b>OS</b>	<b>G7</b>	ON-OFF	220-240V
Fish	34	3098	38	<b>90-A089</b> - <b>H2</b> - <b>OS</b>	<b>G7</b>	ON-OFF	220-240V
Meat	34	1844	38	<b>90-A088</b> - <b>H2</b> - <b>OS</b>	<b>G7</b>	ON-OFF	220-240V

## Totem Double Ø55



○ ●  
H2 G7

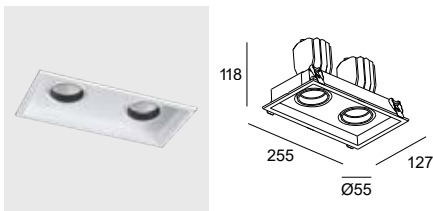

242×114 0-15 mm

LED							
K	CRI	W Total	Real Lm	Optics	Code		
3000	90	2 × 50	4454	38	<b>90-A109</b> - <b>H2</b> - <b>OS</b>	ON-OFF	220-240V
3000	90	2 × 50	4500	24	<b>90-A110</b> - <b>G7</b> - <b>DS</b>	DALI	220-240V
3000	90	2 × 50	4544	15	<b>90-A111</b>		
3500	90	2 × 50	4504	38	<b>90-A106</b> - <b>H2</b> - <b>OS</b>	ON-OFF	220-240V
3500	90	2 × 50	4550	24	<b>90-A107</b> - <b>G7</b> - <b>DS</b>	DALI	220-240V
3500	90	2 × 50	4594	15	<b>90-A108</b>		
4000	90	2 × 50	4630	38	<b>90-A103</b> - <b>H2</b> - <b>OS</b>	ON-OFF	220-240V
4000	90	2 × 50	4678	24	<b>90-A104</b> - <b>G7</b> - <b>DS</b>	DALI	220-240V
4000	90	2 × 50	4724	15	<b>90-A105</b>		

## Totem Double Ø80



○ ●  
H2 G7

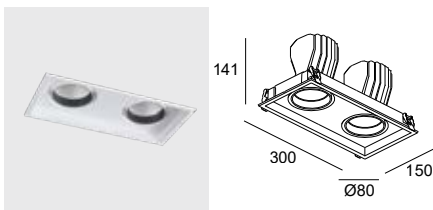

289×137 0-15 mm

LED							
K	CRI	W Total	Real Lm	Optics	Code		
3000	90	2 × 70	6750	24	<b>90-A094</b> - <b>H2</b> - <b>OS</b>	ON-OFF	220-240V
3000	90	2 × 70	6560	38	<b>90-A095</b> - <b>G7</b> - <b>DS</b>	DALI	220-240V
3500	90	2 × 70	6978	24	<b>90-A096</b> - <b>H2</b> - <b>OS</b>	ON-OFF	220-240V
3500	90	2 × 70	6936	38	<b>90-A097</b> - <b>G7</b> - <b>DS</b>	DALI	220-240V
4000	90	2 × 70	7204	24	<b>90-A098</b> - <b>H2</b> - <b>OS</b>	ON-OFF	220-240V
4000	90	2 × 70	7312	38	<b>90-A099</b> - <b>G7</b> - <b>DS</b>	DALI	220-240V

## Totem Triplex Ø55



○ ●  
H2 G7

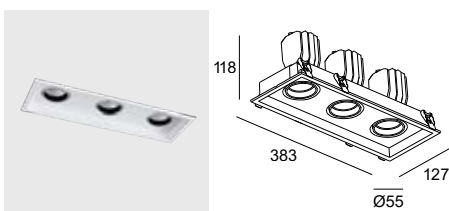

370×114 0-15 mm

LED							
K	CRI	W Total	Real Lm	Optics	Code		
3000	90	3 × 75	6750	24	<b>90-A102</b> - <b>H2</b> - <b>OS</b>	ON-OFF	220-240V
3000	90	3 × 75	6750	24	<b>90-A102</b> - <b>G7</b> - <b>DS</b>	DALI	220-240V
3500	90	3 × 75	6825	24	<b>90-A101</b> - <b>H2</b> - <b>OS</b>	ON-OFF	220-240V
3500	90	3 × 75	6825	24	<b>90-A101</b> - <b>G7</b> - <b>DS</b>	DALI	220-240V
4000	90	3 × 75	7017	24	<b>90-A100</b> - <b>H2</b> - <b>OS</b>	ON-OFF	220-240V
4000	90	3 × 75	7017	24	<b>90-A100</b> - <b>G7</b> - <b>DS</b>	DALI	220-240V



+ Ecofit



## Eficiencia y confort para iluminar espacios de trabajo

## Eficiência e conforto para iluminar espaços de trabalho

Los espacios de trabajo son cada vez más exigentes y requieren iluminación confortable e integradora, que potencie el bienestar y la salud de las personas. Ecofit es una colección de paneles altamente eficientes con dos posibilidades de ópticas para adaptarse a las distintas necesidades de la zona a iluminar.

Os espaços de trabalho são cada vez mais exigentes e requerem iluminação confortável e integradora que potencie o bem-estar e a saúde das pessoas. Ecofit é uma coleção de painéis altamente eficientes com duas possibilidades de óticas para se adaptar às diferentes necessidades da zona a iluminar.



## Luminancia controlada con un alto grado de eficiencia

## Luminância controlada com um elevado grau de eficiência





Ecofit Opticell (UGR < 16) 156 lm / W

Ecofit Plus (UGR < 19) 120 lm / W

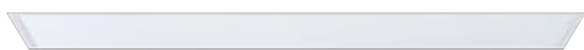
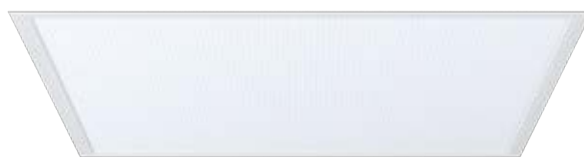

Funcionalidad Smart  
Funcionalidade Smart



Entre las funcionalidades Smart se encuentran el ahorro energético por aportación de luz natural o por presencia y la recogida de datos para monitorizar la ocupación.  
As funcionalidades inteligentes incluem a poupança de energia através da utilização de luz natural ou da presença e recolha de dados para monitorizar a ocupação.

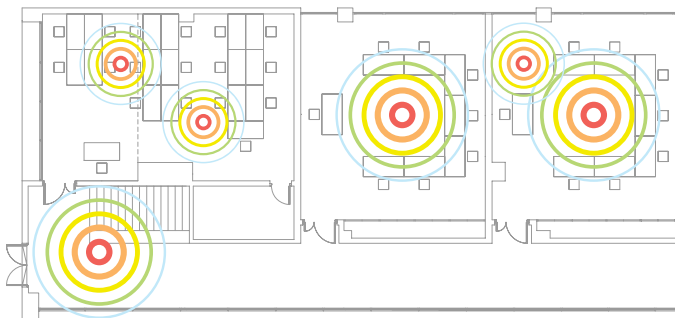

Altura reducida para facilitar la integración  
Altura reduzida para facilitar a integração









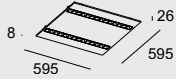

BODY MAT	50000h	3
AL	L80 B20	MacAdam

## Ecofit Pro Standard

NEW	IP 40	DIF MAT PMMA	UGR <19		
-----	----------	-----------------	------------	--	--



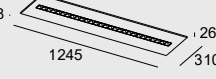



Ejemplo de código / Exemplo de código: **AQ11-3PW8F3OS14**

Model	W	K / CRI / Real lm	Optics	Source	Finishes
<b>AQ11 -</b> Square / 59,5 × 59,5 IP40  	3P 32.3W	<b>W8</b> 3000K / CRI80 / 4402 lm	<b>F3</b> Opticell	<b>OS</b> ON-OFF 220-240V	<b>14</b>
		<b>W9</b> 3000K / CRI90 / 3962 lm		<b>DS</b> DALI-2 220-240V	
		<b>X8</b> 4000K / CRI80 / 4596 lm		<b>XB</b> CASAMBI 220-240V	
		<b>X9</b> 4000K / CRI90 / 3962 lm			
<b>AQ12 -</b> Square / 62 × 62 IP40  	3P 23.5W	<b>U8</b> TW 2700K-6500K / CRI80 / 3424 lm	<b>F3</b> Opticell	<b>TW</b> DALI DT8 220-240V	
<b>AQ13 -</b> Rectangular / 119,5 × 29,5 IP40  					
<b>AQ14 -</b> Rectangular / 124,5 × 31 IP40  					

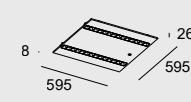
# Ecofit Pro S.Enlighted

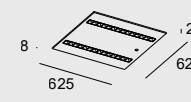
--	--	--	--	--	--	--	--	--

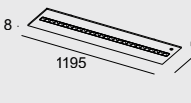
Ejemplo de código / Exemplo de código: **AQ31-3PW8F3WR14**

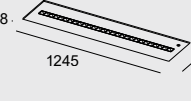
Model	W	K / CRI / Real lm	Optics	Source	Finishes
<b>AQ31 -</b> Square / 59,5 × 59,5 IP40  	<b>3P</b> 32.3W	<b>W8</b> 3000K / CRI80 / 4402 lm	<b>F3</b> Opticell	<b>WR</b> DALI D4i 220-240V	<b>14</b>
<b>AQ32 -</b> Square / 62 × 62 IP40  		<b>W9</b> 3000K / CRI90 / 3962 lm			
<b>AQ33 -</b> Rectangular / 119,5 × 29,5 IP40  		<b>X8</b> 4000K / CRI80 / 4596 lm			
<b>AQ34 -</b> Rectangular / 124,5 × 31 IP40  		<b>X9</b> 4000K / CRI90 / 3962 lm			

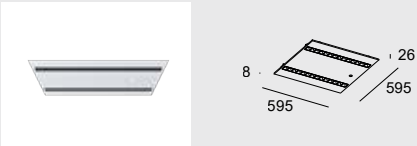
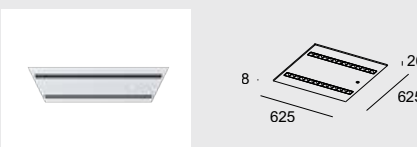
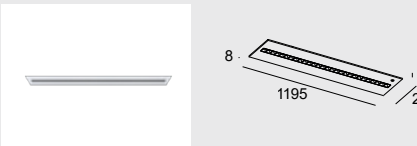
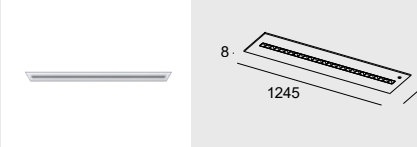

Ejemplo de código / Exemplo de código: **AQ21-3PW8F3WR14**

Model	W	K / CRI / Real lm	Optics	Source	Finishes
<b>AQ21 -</b> Square / 59,5 × 59,5 	<b>3P</b> 32.3W	<b>W8</b> 3000K / CRI80 / 4402 lm	<b>F3</b> Opticell	<b>WR</b> DALI D4i 220-240V	<b>14</b>
<b>AQ22 -</b> Square / 62 × 62 		<b>W9</b> 3000K / CRI90 / 3962 lm			
<b>AQ23 -</b> Rectangular / 119,5 × 29,5 		<b>X8</b> 4000K / CRI80 / 4596 lm			
<b>AQ24 -</b> Rectangular / 124,5 × 31 		<b>X9</b> 4000K / CRI90 / 3962 lm			

Ecofit Opticell  
600 × 600mm



Ecofit Opticell  
1200 × 300mm



Ecofit Opticell  
625 × 625mm



Ecofit Opticell  
1245 × 308mm



**Fuentes de alimentación**  
Fontes de alimentação

P. 1166



Fuente de alimentación Emergency  
Fonte de alimentação Emergency

14

**71-A223-14-00**

**Accesorios de fijación requeridos**  
Acessórios de fixação requeridos



Florón suspendido con toma de corriente DALI  
Florão suspenso com tomada de corrente DALI

14

**71-7521-14-00**







**71-7521-14-00**

BODY MAT	50000h	3
AL	L80 B20	MacAdam

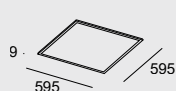
## Ecofit Plus Standard

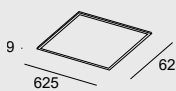

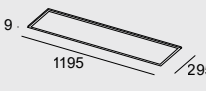
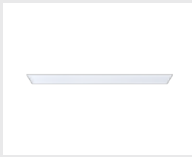



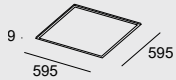

NEW	IP 40	UGR <16	
-----	----------	------------	--

Ejemplo de código / Exemplo de código: **AP11-35W8MP0S14**



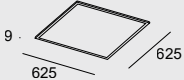

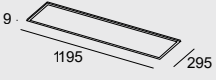
Model	W	K / CRI / Real lm	Optics	Source	Finishes
<b>AP11 -</b> Square / 60 × 60 IP40  	35 32.8W	<b>W8</b> 3000K / CRI80 / 3697 lm	<b>MP</b> Microprisma	<b>OS</b> ON-OFF 220-240V	<b>14</b>
		<b>W9</b> 3000K / CRI90 / 3364 lm		<b>DS</b> DALI-2 220-240V	
		<b>X8</b> 4000K / CRI80 / 3851 lm		<b>XB</b> CASAMBI 220-240V	
		<b>X9</b> 4000K / CRI90 / 3504 lm		<b>BB</b> 36V/max.900mA	
<b>AP12 -</b> Square / 62,5 × 62,5 IP40  	35 36W	<b>U8</b> TW 2700- 6500K / CRI80 / 3586 lm	<b>MP</b> Microprisma	<b>TW</b> DALI DT8 220-240V	
		<b>XC</b> CASAMBI 220-240V			
<b>AP13 -</b> Rectangular / 119,5 × 29,5 IP40  					
<b>AP14 -</b> Rectangular / 124,5 × 31 IP40  					

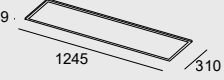



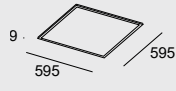

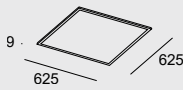
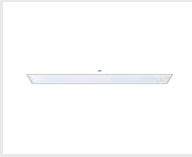
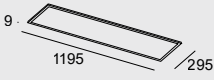
Ejemplo de código / Exemplo de código: **AP41-35W8MPWR14**

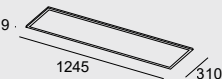
Model	W	K / CRI / Real lm	Optics	Source	Finishes
<b>AP41 -</b> Square / 60 × 60  	<b>35</b> 34.7W	<b>W8</b> 3000K / CRI80 / 3697 lm	<b>MP</b> Microprisma	<b>WR</b>   DALI D4i 220-240V	<b>14</b> 
<b>AP42 -</b> Square / 62,5 × 62,5  		<b>W9</b> 3000K / CRI90 / 3364 lm			
<b>AP43 -</b> Rectangular / 119,5 × 29,5  		<b>X8</b> 4000K / CRI80 / 3851 lm			
<b>AP44 -</b> Rectangular / 124,5 × 31  		<b>X9</b> 4000K / CRI90 / 3504 lm			

Ejemplo de código / Exemplo de código: **AP31-35W8MPWR14**

Model	W	K / CRI / Real lm	Optics	Source	Finishes
<b>AP31 -</b> Square / 60 × 60   	<b>35</b> 34.7W	<b>W8</b> 3000K / CRI80 / 3697 lm	<b>MP</b> Microprisma	<b>WR</b> (S) DALI D4i 220-240V	<b>14</b> (S)
<b>AP32 -</b> Square / 62,5 × 62,5   		<b>W9</b> 3000K / CRI90 / 3364 lm			
<b>AP33 -</b> Rectangular / 119,5 × 29,5   		<b>X8</b> 4000K / CRI80 / 3851 lm			
<b>AP34 -</b> Rectangular / 124,5 × 31   		<b>X9</b> 4000K / CRI90 / 3504 lm			

Ecofit Plus 600 × 600mm	Ecofit Plus 1200 × 300mm	Ecofit Plus 625 x 625mm	Ecofit Plus 1245 × 308mm
			

**Accesorios de fijación requeridos**  
Acessórios de fixação requeridos

	Florón suspendido con toma de corriente DALI 14 (S)	<b>71-7521-14-00</b>	<b>71-7521-14-00</b>	-	-
	Florão suspenso com tomada de corrente DALI				

# Kiva Recessed

FAMILIA/FAMILIA: Low Voltage: , Spotlights / Ceilings:



De estética delicada y sencilla, Kiva es una solución ideal para iluminar con precisión espacios que requieren diseño y técnica a partes iguales. Su capacidad de rotación, tanto longitudinal como giratoria, permite focalizar fácilmente el haz de luz allí donde el proyecto lo requiere.

Com uma estética delicada e simples, Kiva é a solução ideal para iluminar com precisão espaços que requerem design e técnica em partes iguais. A sua capacidade de rotação, tanto longitudinal como rotativa, facilita a focalização do feixe de luz onde o projeto o requer.

Rotación longitudinal y giratoria  
Rotação longitudinal e giratória



14

60

81

DN





# Kiva Recessed

BODY MAT		50000h	2
AL		L80 B20	MacAdam

## Kiva Recessed 75mm

	IP 23	UGR <16					
			90°	360°			

14 60 81 DN

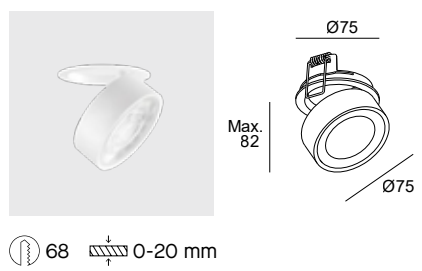

LED									
K	CRI	W	Total	Real	Lm	Optics	Code		
2700	90	8.8	458	19°	90-8035	14	OU	ON-OFF	100-240V
						60	DS	DALI-2	100-240V
						81	XB	CASAMBI	220-240V
						DN			
3000	90	8.8	530	19°	90-8036	14	OU	ON-OFF	100-240V
						60	DS	DALI-2	100-240V
						81	XB	CASAMBI	220-240V
						DN			

## Kiva Recessed 95mm

	IP 23	UGR <16					
			90°	360°			

14 60 81 DN

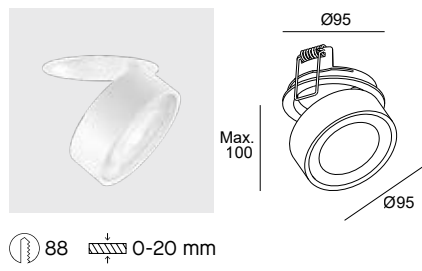

LED									
K	CRI	W	Total	Real	Lm	Optics	Code		
2700	90	14	1172	23°	90-8037	14	OU	ON-OFF	100-240V
						60	DS	DALI-2	100-240V
						81	XB	CASAMBI	220-240V
						DN			
3000	90	14	1320	23°	90-8038	14	OU	ON-OFF	100-240V
						60	DS	DALI-2	100-240V
						81	XB	CASAMBI	220-240V
						DN			

# Iris

## Spotlight







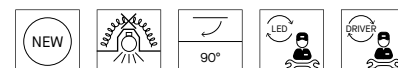







BODY MAT		50000h	2
AL		L80 B20	MacAdam

# Iris Proyector

## Empotrado



Ejemplo de código / Exemplo de código: **AV11-P6V9U10S60**

Model	W	K / CRI / Real lm	Shade	Optics	Source	Finishes*						
 <p><b>AV11 -</b> Spotlight Trim 0-20 mm IP23</p> 	<b>P6</b> 6.3W	<b>V9</b> 2700K / CRI90 / 533 lm	<b>U</b> Hoop 	<b>1</b> 15°	<b>OS</b>  ON-OFF 100-240V	<b>60</b>  <b>L7</b> 						
		<b>W9</b> 3000K / CRI90 / 268 lm	<b>2</b> 35°				<b>DS</b>  DALI-2 110-277V	<b>L8</b>  <b>L9</b> 				
		<b>X9</b> 4000K / CRI90 / 707 lm							<b>3</b> 50°	<b>01</b>  <b>02</b> 		
		4000K / CRI90 / 461 lm									<b>07</b>  <b>08</b> 	
		4000K / CRI90 / 466 lm										<b>X</b> Cone 
		<b>12</b> 12.5W										
<b>W9</b> 3000K / CRI90 / 555 lm												
<b>X9</b> 4000K / CRI90 / 1477 lm	<b>Z</b> Pipe 											
4000K / CRI90 / 966 lm												
4000K / CRI90 / 1023 lm												
<b>18</b> 18.1W			<b>V9</b> 2700K / CRI90 / 1592 lm									
		<b>W9</b> 3000K / CRI90 / 761 lm										
		<b>X9</b> 4000K / CRI90 / 2037 lm										
	4000K / CRI90 / 1360 lm											
	4000K / CRI90 / 1422 lm											

\*Consulta las combinaciones de acabados a través del configurador online [iris-ledsc4.com](http://iris-ledsc4.com)

\*Consulte as combinações de acabamentos através do configurador online [iris-ledsc4.com](http://iris-ledsc4.com)





**Iris Proyector Empotrado con Marco**



**Iris Proyector Empotrado sin Marco**



**Accesorios ópticos**  
Acessórios óticos

	Difusor elíptico (5u.) Difusor elíptico (5u.)	<b>71-5167-00-00</b>	<b>71-5167-00-00</b>
	Difusor cuadrado (5u.) Difusor quadrado (5u.)	<b>71-5658-00-00</b>	<b>71-5658-00-00</b>
	Difuminador de halo (5u.) Difusor opalino (5u.)	<b>71-6099-00-00</b>	<b>71-6099-00-00</b>
	Panel de abeja (5u.) Painel de abelha (5u.)	<b>71-5166-60-00</b>	<b>71-5166-60-00</b>
	Apantallador (5u.) Obturador assimétrico (5u.)	60 ● <b>71-7895-60-00</b>	<b>71-7895-60-00</b>

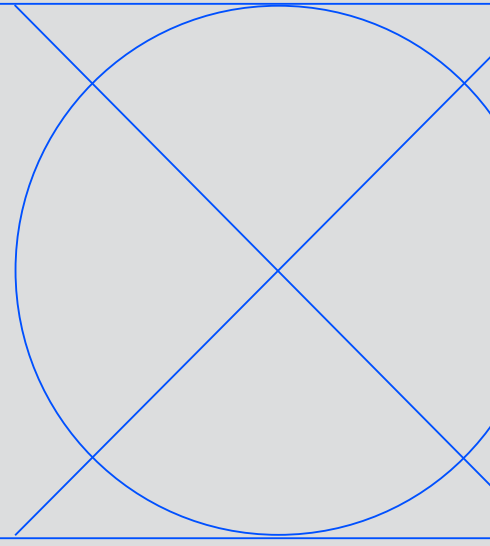

# Colgantes / Apliques

## Suspensões / Apliques

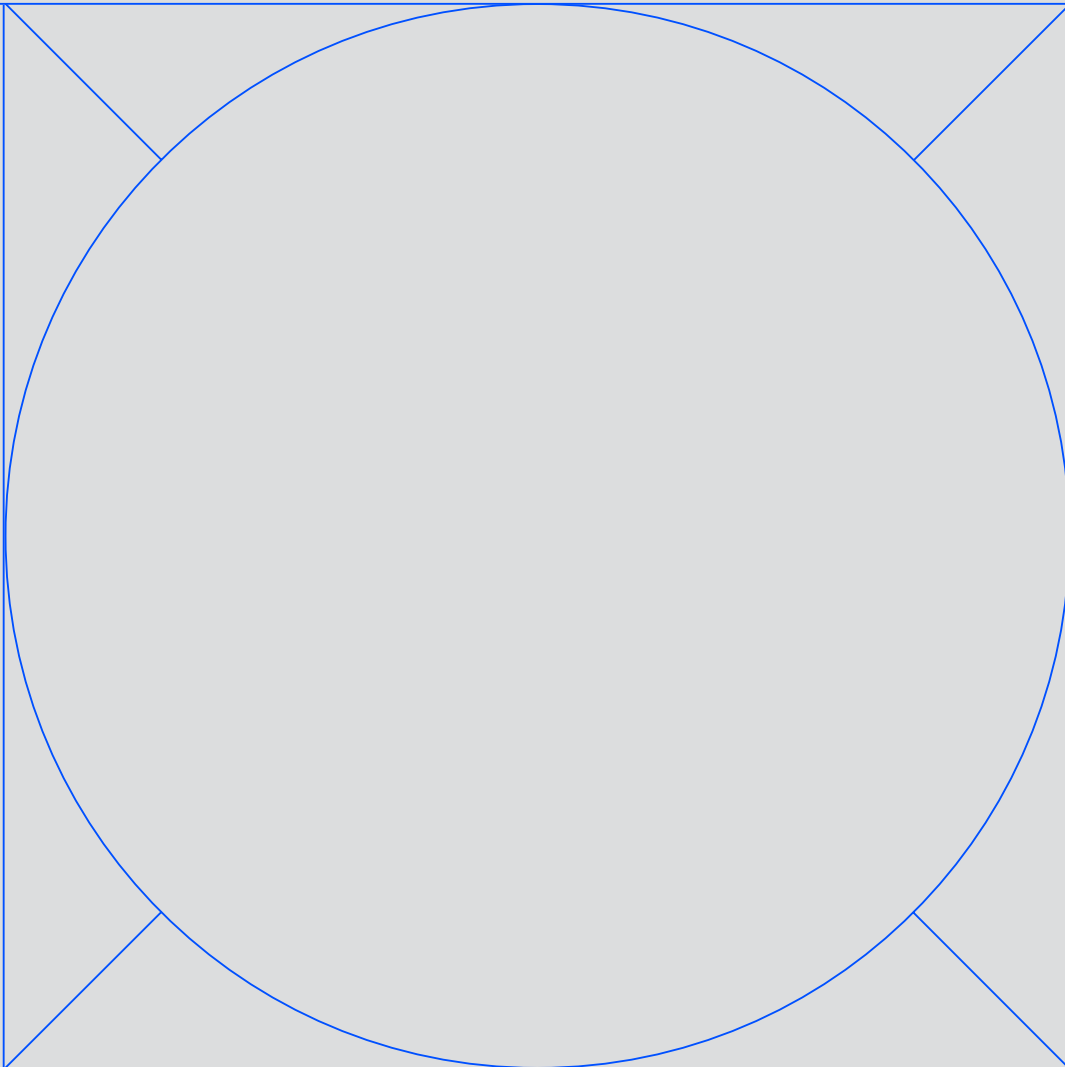

**Pek**  
**282**

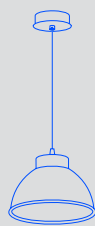

**Luno Slim**  
**284**

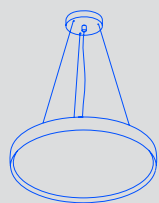

**Luno**  
**288**

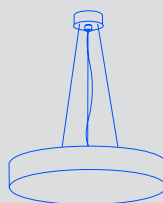

**Iris**  
**290**



**Play**  
**294**



**Maai**  
**295**

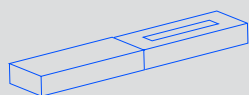

# Pek



Con una clásica forma de campana, en acabado negro mate y blanco, Pek proporciona un alto flujo lumínico sin renunciar al estilo, ya que aporta un alto valor estético al espacio.

Com uma forma clássica de sino, em acabamento preto e branco mate, Pek fornece um elevado fluxo lumínico sem renunciar ao estilo, já que proporciona um alto valor estético ao espaço.



Posibilidad de instalación en carril mediante un accesorio de conexión o como colgante, con una medida ajustable del cable desde 470 mm a 2800 mm

Pode ser instalado numa calha através de um acessório de ligação ou como suspensão, com uma medida de cabo ajustável de 470mm a 2800mm

## Pek LED

IP
20

UGR
<22

50000h
L80 B20

2
MacAdam



○ ●  
14 60

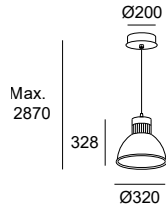

LED						
K	CRI	W Total	Real Lm	Code		
3000	80	35.2	2512	<b>00-4941</b>		
3000	80	35.2	4193	<b>00-4947</b>	- 60	ON-OFF 100-240V
3000	90	35.2	3347	<b>00-4953</b>	- 14	
4000	80	35.2	2512	<b>00-4944</b>	- 14	ON-OFF 100-240V
4000	80	35.2	4193	<b>00-4950</b>	- 60	

## Pek E27

IP
20

○ ●  
14 60

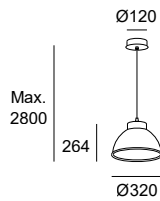
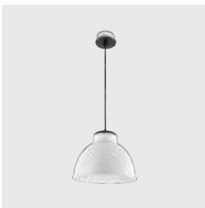

E27	
W	Code
Max. 15	<b>00-4962</b> - 14 - 00 60

### Pek LED



### Pek E27



## Accesorios de conexión Acessórios de conexão



Conector de carril  
Conetor de calha

60 ●

-

**71-3531-60-00**



# Luno Slim Pendant

Designed by LedsC4 Architectural

FAMILIA/FAMILIA: Downlights P.000. Ceiling P.000.

## Máximo rendimiento y confort Máximo rendimiento e conforto

Luno Slim es la opción ideal para iluminar aquellas zonas que por su funcionalidad requieren una máxima eficiencia. Disponible en tres temperaturas de color y distintos tamaños y acabados.

Luno Slim é a opção ideal para iluminar as zonas que pela sua funcionalidade requerem a máxima eficiência. Disponível em diferentes temperaturas de cor, tamanhos e acabamentos.



Difusor microprismático con una eficiencia de hasta 120 lm / w

Difusor microprismático con una eficiencia de hasta 120 lm / w





**Luno Slim Pendant.** Proyecto Iberspa. Lleida. Instalación luminica conectiva que respeta el ritmo circadiano de las personas y contribuye al ahorro energético. Fotografía: Jordi Anguera.

**Luno Slim Pendant.** Projeto Iberspa. Lèrida. Instalação de iluminação conectiva que respeita o ritmo circadiano das pessoas e contribui para o Poupança de energia. Fotografía: Jordi Anguera

Perfil especialmente fino  
Perfil especialmente fino

60 mm

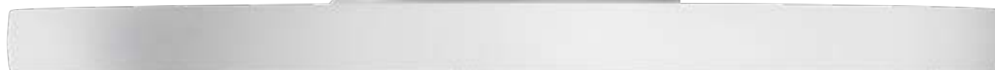

Tensores de cable especiales para dar la rigidez y consistencia adecuada a la pieza  
Tensores de cabo especiais para dar a rigidez e consistência certas à peça

# Luno Slim Pendant

BODY MAT	DIF MAT		50000h	3
AL	PC		L80 B20	MacAdam

INDOOR

## Luno Slim Pendant Small

	IP	UGR		
	20	<19		

Ejemplo de código / Exemplo de código: **AR21-27W9MPDS14**

Model	W	K / CRI / Real lm	Optics	Source	Finishes
<b>AR21 -</b>  	<b>27</b> 27.8W	<b>W9</b> 3000K / CRI90 / 3037 lm	<b>MP</b> Microprisma	<b>DS</b> ON-OFF & DALI-2 220-240V	<b>14</b> <b>60</b>
		<b>X9</b> 4000K / CRI90 / 3158 lm			

## Luno Slim Pendant Medium

	IP	UGR		
	20	<19		

Ejemplo de código / Exemplo de código: **AR22-37W9MPDS14**

Model	W	K / CRI / Real lm	Optics	Source	Finishes
<b>AR22 -</b>  	<b>37</b> 37.8W	<b>W9</b> 3000K / CRI90 / 3956 lm	<b>MP</b> Microprisma	<b>DS</b> ON-OFF & DALI-2 220-240V	<b>14</b> <b>60</b>
		<b>X9</b> 4000K / CRI90 / 4114 lm			

## Luno Slim Pendant Large

	IP	UGR		
	20	<16		

Ejemplo de código / Exemplo de código: **AR23-72W9MPDS14**

Model	W	K / CRI / Real lm	Optics	Source	Finishes
<b>AR23 -</b>  	<b>72</b> 71.3W	<b>W9</b> 3000K / CRI90 / 6917 lm	<b>MP</b> Microprisma	<b>DS</b> ON-OFF & DALI-2 220-240V	<b>14</b> <b>60</b>
		<b>X9</b> 4000K / CRI90 / 7194 lm			

## Luno Slim Pendant Extra Large

	IP	UGR		
	20	<16		

Ejemplo de código / Exemplo de código: **AR24-CPW9MPDS14**

Model	W	K / Cri / Real lm	Optics	Source	Finishes
<b>AR24 -</b>  	<b>CP</b> 108.2W	<b>W9</b> 3000K / CRI90 / 9863 lm	<b>MP</b> Microprisma	<b>DS</b> ON-OFF & DALI-2 220-240V	<b>14</b> <b>60</b>
		<b>X9</b> 4000K / CRI90 / 10257 lm			

COLGANTES / APLIQUES | SUSPENSÕES / APLIQUES

# Luno

BODY MAT	DIF MAT		50000h	3
AL	PMMA		L80 B20	MacAdam

## Luno Pendant ø400

IP	UGR	WELL		
20	<22			

14 60 DL\*

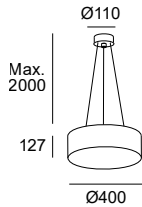

LED							
K	CRI	W Total	Real Lm	Code			
3000	80	27.5	2389	<b>00-5922</b>	<b>14</b>	<b>OU</b>	ON-OFF 100-240V
					<b>- 60</b>	<b>RU</b>	1-10V 100-240V
					<b>DL</b>		
4000	80	27.5	2389	<b>00-5923</b>	<b>14</b>	<b>OU</b>	ON-OFF 100-240V
					<b>- 60</b>	<b>RU</b>	1-10V 100-240V
					<b>DL</b>		

## Luno Pendant ø1200

IP	WELL		
20			

14 60 DL\*

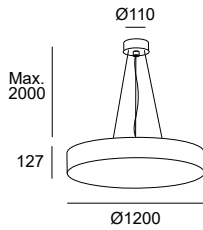

LED							
K	CRI	W Total	Real Lm	Code			
3000	80	161.3	15065	<b>00-5928</b>	<b>14</b>	<b>OU</b>	ON-OFF 100-240V
					<b>- 60</b>	<b>RU</b>	0-10V 100-240V
					<b>DL</b>		
4000	80	161.3	15065	<b>00-5929</b>	<b>14</b>	<b>OU</b>	ON-OFF 100-240V
					<b>- 60</b>	<b>RU</b>	0-10V 100-240V
					<b>DL</b>		



INDOOR

COLGANTES / APLIQUES | SUSPENSÕES / APLIQUES

# Iris Pendant

Designed by Artec Studio



+ Iris

FAMILIA/FAMILIA: Wall Fixture P.000. Ceiling P.000. Low Voltaje P.000. Tree-Phase P.000. Floor Lamp P.000. Table Lamp P.000



Modulable en cuerpo y alma, Iris aporta al espacio un carisma orgánico  
Modulável no corpo e alma, Iris dá carisma ao espaço

Gracias a su carácter orgánico, Iris se apropia de los espacios con carisma, ofreciendo una iluminación de calidad sin renunciar a un componente estético y al juego compositivo de sus componentes y acabados.

Graças ao seu caráter orgânico, Iris apropria-se de espaços com carisma, oferecendo uma iluminação de qualidade sem renunciar a uma componente estética e ao jogo composicional dos seus componentes e acabamentos.



Opción de controlar el haz de luz gracias a los accesorios disponibles

Opção de controlar o feixe de luz graças aos acessórios disponíveis











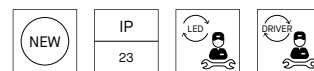

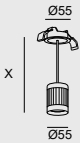

# Iris Pendant

BODY MAT		50000h	2
AL		L80 B20	MacAdam

## Iris Colgante

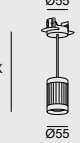

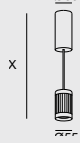



Ejemplo de código / Exemplo de código: **AV14-P6V9U10S60**





Model	W	K / CRI / Real lm	Shade	Optics	Source	Finishes
 <p><b>AV14 -</b> Pendant Trim 0-20 mm <math>\varnothing</math> 57</p> 	<b>P6</b> 6.3W	<b>V9</b> 2700K / CRI90 / 533 lm	<b>U</b> Hoop 	<b>1</b> 15°	<b>OS</b>  ON-OFF 220-240V	<b>60</b>  <b>L7</b>  <b>L8</b>  <b>L9</b>  <b>O1</b>  <b>O2</b>  <b>O7</b>  <b>O8</b> 
		<b>W9</b> 3000K / CRI90 / 268 lm	<b>2</b> 35°	<b>DS</b>   DALI-2 110-277V		
		<b>X9</b> 4000K / CRI90 / 707 lm	<b>3</b> 50°			
 <p><b>AV15 -</b> Pendant Trimless 0-20 mm <math>\varnothing</math> 57</p> 	<b>12</b> 12.5W	<b>V9</b> 2700K / CRI90 / 1183 lm	<b>V</b> Visual Comfort 			
		<b>W9</b> 3000K / CRI90 / 555 lm	<b>X</b> Cone 			
		<b>X9</b> 4000K / CRI90 / 1477 lm				
 <p><b>AV16 -</b> Pendant Surface</p> 	<b>18</b> 18.1W	<b>V9</b> 2700K / CRI90 / 1592 lm	<b>Y</b> Glass 			
		<b>W9</b> 3000K / CRI90 / 761 lm				
 <p><b>AV26 -</b> Pendant Surface Big IP23</p> 		<b>X9</b> 4000K / CRI90 / 2037 lm	<b>Z</b> Pipe 			

\*Consulta las combinaciones de acabados a través del configurador online [iris-ledsc4.com](http://iris-ledsc4.com)

\*Consulte as combinações de acabamentos através do configurador online [iris-ledsc4.com](http://iris-ledsc4.com)

Iris Colgante Con Marco	Iris Colgante Superficie	Iris Colgante Sin Marco	Iris Colgante Superficie Grande
			

**Accesorios ópticos**  
Acessórios óticos

	Difusor elíptico (5u.) Difusor elíptico (5u.)	71-5167-00-00	71-5167-00-00	71-5167-00-00	71-5167-00-00
	Difusor cuadrado (5u.) Difusor quadrado (5u.)	71-5658-00-00	71-5658-00-00	71-5658-00-00	71-5658-00-00
	Difuminador de halo (5u.) Difusor opalino (5u.)	71-6099-00-00	71-6099-00-00	71-6099-00-00	71-6099-00-00
	Panel de abeja (5u.) Painel de abelha (5u.)	71-5166-60-00	71-5166-60-00	71-5166-60-00	71-5166-60-00
	Apantallador (5u.) Obturador assimétrico (5u.)	60 ● 71-7895-60-00	71-7895-60-00	71-7895-60-00	71-7895-60-00

# Play

Designed by LedsC4 Architectural



Play Deco se presenta en opción colgante como novedad en toda la variedad de acabados, para proyectos que requieren tecnicidad y diseño a partes iguales.

Play Deco está disponível na opção suspensão como novidade em toda a variedade de acabamentos, para projetos que requerem tecnicidade e design em igual medida.

BODY MAT	DIF MAT		50000h	2	NEW	LED	DRIVER
AL	PMMA		L80 B20	MacAdam			

Ejemplo de código / Exemplo de código: **AG68-P7V9S20UWG**

Model	W	K / Cri / Real lm	Optics	Source	Finishes
<p><b>AG68 -</b></p>	<b>P7</b> 8.6W	<b>V9</b> 2700K / CRI90 / 549 lm (M2)	<b>S2</b> 14°	<b>OU</b> ON-OFF 100-240V	<b>WG</b> <b>WH</b> <b>WL</b> <b>WM</b> <b>WN</b> <b>WR</b>
		<b>W9</b> 3000K / CRI90 / 637 lm (M2)	<b>M2</b> 28°	<b>DU</b> DALI-2 110-277V	
		<b>X9</b> 4000K / CRI90 / 637 lm (M2)	<b>F1</b> 49°	<b>TS</b> PHASE CUT 220-240V	
	<b>13</b> 14.4W	<b>V9</b> 2700K / CRI90 / 1159 lm (M2)	<b>S2</b> 19°	<b>TS</b> PHASE CUT 220-240V	
		<b>W9</b> 3000K / CRI90 / 1248 lm (M2)	<b>M2</b> 34°		
		<b>X9</b> 4000K / CRI90 / 1335 lm (M2)	<b>F1</b> 45°		

Controladores  
Controladores

P. 1166



CASAMBI  
IP20

71-A260-00-00



## Fusión perfecta entre estética y tecnología Fusão perfeita entre a estética e a tecnologia

De la colaboración entre Artec Studio y LedsC4 nace este aplique versátil de estructura ligera y equilibrada, fácilmente adaptable a cualquier espacio.

Da colaboração entre Summalab e LedsC4, nasce este aplique versátil de estrutura leve e equilibrada, facilmente adaptável a qualquer espaço.



BODY MAT	DIF MAT		50000h	3	IP				
AL	ACR		L80 B20	MacAdam	20		350		

14

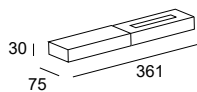

LED									
K	CRI	W Total	Real Lm	Code					
3000	80	13.2	1042	05-6399 - 14	-	OU	ON-OFF 100-240V		
					-	DU	DALI 100-240V		
3000	80	28	1908	05-6408 - 14	-	OU	ON-OFF 100-277V		
					-	DS	DALI 220-240V		
4000	80	13.2	1097	05-6405 - 14	-	OU	ON-OFF 100-240V		
					-	DU	DALI 100-240V		
4000	80	28	2010	05-6411 - 14	-	OU	ON-OFF 100-277V		
					-	DS	DALI 220-240V		

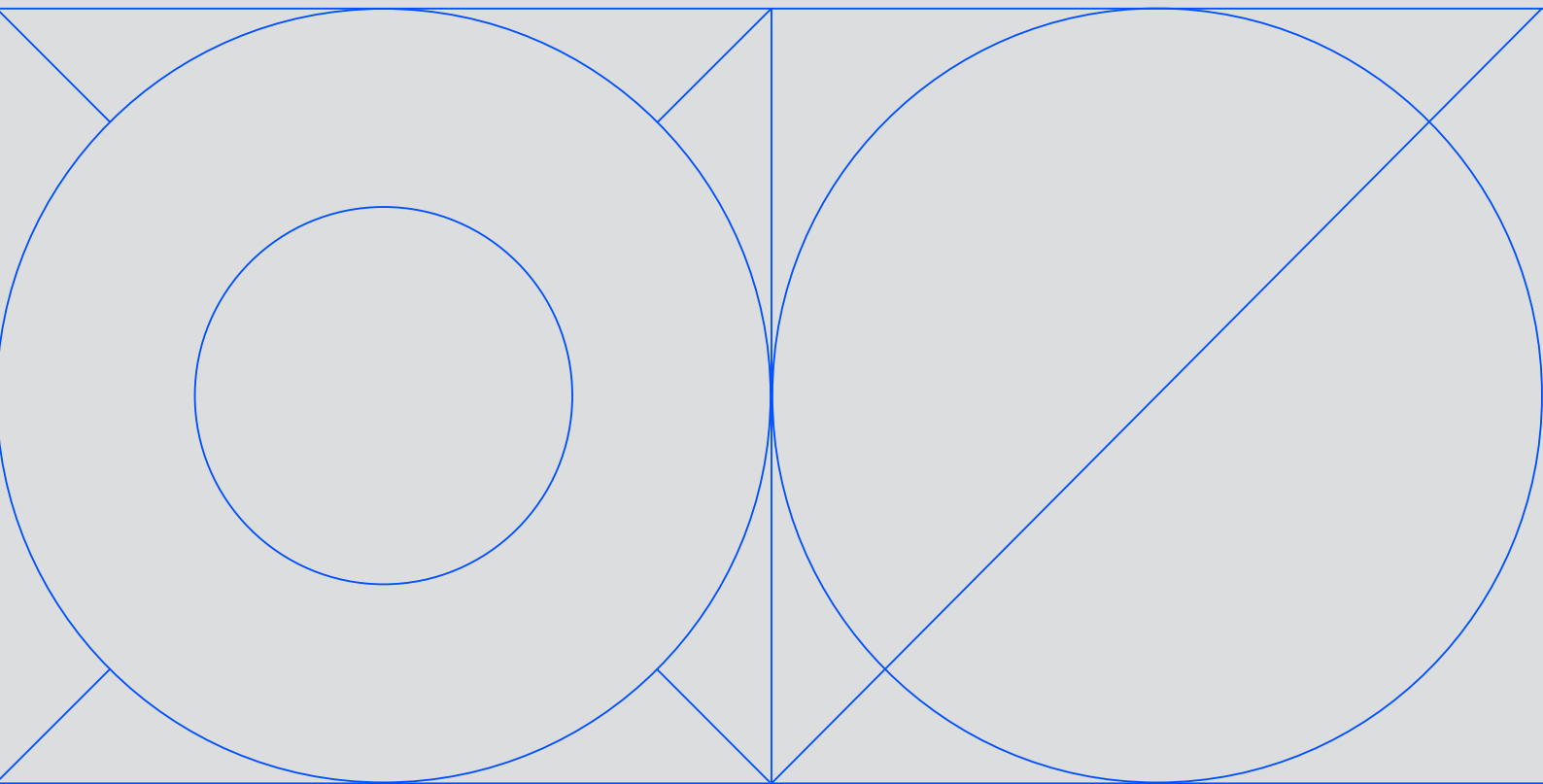

Proyectores / Plafones  
Projectores / Plafons

---

Iris Ceiling

298

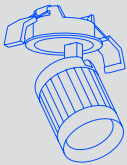

Iris Spotlight

298



Leco

303

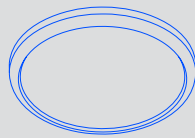

Luno Slim

304



Luno Surface

308

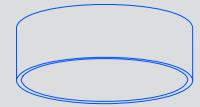

Ges

310

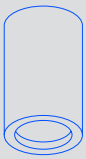

Play Deco

311



Exit

312



Multidir EVO

314

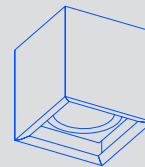

Atom Hide

326

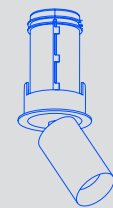

Atom Surface

320

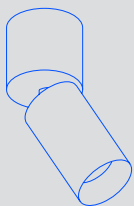

Bento Surface

335

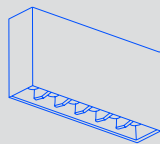

Bento IP

338

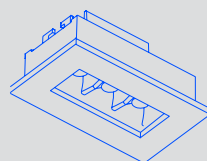

Kiva

340





# Iris

Designed by Artec Studio



+ Iris



La colección Iris cuenta con versiones de plafón y proyectores, solución ideal para proyectos que requieran de una gama cromática extensa y de calidad, como una galería de arte o similar.

A coleção Iris possui versões de plafon e projetores, solução ideal para projetos que requerem uma gama cromática extensa e de qualidade, como uma galeria de arte ou similar.



## Accesorios que moldean la luz Acessórios que moldam a luz

Iris permite la instalación de accesorios con diversos usos, como acentuar el haz para focalizar sobre objetos precisos.

Iris permite a instalação de acessórios com diferentes utilizações, tais como acentuar o feixe para se concentrar em objetos específicos.

Accesorio Panel de abeja. Aumenta el confort visual y remarca el ángulo de salida.  
Acessório Painel de abelha. Aumenta o conforto visual e enfatiza o ângulo de saída.



Proyecto oficinas Six'n'Five Barcelona. **Iris** cuenta con una reproducción cromática CRI90 que respeta los colores de los objetos expuestos, potenciándolos. Fotografía: Enric Badrinas.  
Projeto escritórios Six'n'Five Barcelona. **Iris** possui uma reprodução cromática CRI90 que respeita as cores dos objetos expostos, potenciando-os. Fotografia: Enric Badrinas.





# Iris Ceiling

BODY MAT		50000h	2
AL		L80 B20	MacAdam

## Iris Ceiling

	IP 23		
-------------------------------------------------------------------------------------	----------	-------------------------------------------------------------------------------------	-------------------------------------------------------------------------------------

Ejemplo de código / Exemplo de código: **AV17-P6V9U10S60**

Model	W	K / Cri / Real lm	Shade	Optics	Source	Finishes*
 <p><b>AV17 -</b> Ceiling Surface IP23</p> 	<b>P6</b> 6.3W	<b>V9</b> 2700K / CRI90 / 533 lm	<b>U</b> Hoop 	<b>1</b> 15°  <b>2</b> 35°  <b>3</b> 50°	<b>OS</b>  ON-OFF 220-240V  <b>DS</b>   DALI-2 110-277V	<b>60</b>  <b>L7</b>  <b>03</b>  <b>04</b>  <b>09</b>  <b>P7</b> 
		<b>W9</b> 3000K / CRI90 / 268 lm	<b>V</b> Visual Comfort 			
		<b>X9</b> 4000K / CRI90 / 707 lm				
	<b>12</b> 12.5W	<b>V9</b> 2700K / CRI90 / 1183 lm	<b>X</b> Cone 			
		<b>W9</b> 3000K / CRI90 / 555 lm				
		<b>X9</b> 4000K / CRI90 / 1477 lm				
 <p><b>AV27 -</b> Ceiling Surface Big IP23</p> 	<b>18</b> 18.1W	<b>V9</b> 2700K / CRI90 / 1592 lm	<b>Y</b> Glass 			
		<b>W9</b> 3000K / CRI90 / 761 lm				
		<b>X9</b> 4000K / CRI90 / 2037 lm		<b>Z</b> Pipe 		

\*Consulta las combinaciones de acabados a través del configurador online [iris-ledsc4.com](http://iris-ledsc4.com)  
 \*Consulte as combinações de acabamentos através do configurador online [iris-ledsc4.com](http://iris-ledsc4.com)

# Iris

## Spotlight Surface





BODY MAT		50000h	2
AL		L80 B20	MacAdam

INDOOR

## Iris Spotlight Surface

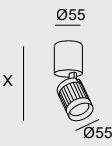
IP	NEW	90°	LED	DRIVER
23				

Ejemplo de código / Exemplo de código: **AV13-P6V9U10S60**

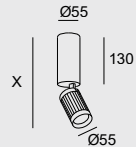
Model	W	K / Cri / Real lm	Shade	Optics	Source	Finishes								
 <p><b>AV13 -</b> Spotlight Surface IP23</p> 	<b>P6</b> 6.3W	<b>V9</b> 2700K / CRI90 / 533 lm	<b>U</b> Hoop 	<b>1</b> 15°	<b>OS</b> ON-OFF 220-240V	<b>60</b>								
		<b>W9</b> 3000K / CRI90 / 268 lm	<b>V</b> Visual Comfort 				<b>2</b> 35°	<b>DS</b> DALI-2 110-277V	<b>L7</b>					
		<b>X9</b> 4000K / CRI90 / 707 lm								<b>X</b> Cone 	<b>3</b> 50°	<b>O3</b>		
	<b>12</b> 12.5W	<b>V9</b> 2700K / CRI90 / 1183 lm	<b>Y</b> Glass 										<b>O4</b>	
		<b>W9</b> 3000K / CRI90 / 555 lm												<b>Z</b> Pipe 
		<b>X9</b> 4000K / CRI90 / 1477 lm								<b>P7</b>				
 <p><b>AV28 -</b> Spotlight Surface Big IP23</p> 	<b>18</b> 18.1W	<b>V9</b> 2700K / CRI90 / 1592 lm												
		<b>W9</b> 3000K / CRI90 / 761 lm												
		<b>X9</b> 4000K / CRI90 / 2037 lm												

PROYECTORES / PLAFONES | PROJETORES / PLAFONS

\*Consulta las combinaciones de acabados a través del configurador online [iris-ledsc4.com](http://iris-ledsc4.com)  
 \*Consulte as combinações de acabamentos através do configurador online [iris-ledsc4.com](http://iris-ledsc4.com)

## Iris Plafón Superficie

## Iris Plafón Superficie Grande

**Accesorios ópticos**  
**Acessórios óticos**

Difusor elíptico (5u.)  
Difusor elíptico (5u.)

71-5167-00-00

71-5167-00-00



Difusor cuadrado (5u.)  
Difusor quadrado (5u.)

71-5658-00-00

71-5658-00-00



Difuminador de halo (5u.)  
Difusor opalino (5u.)

71-6099-00-00

71-6099-00-00



Panel de abeja (5u.)  
Painel de abelha (5u.)

60 ●

71-5166-60-00

71-5166-60-00



Apantallador (5u.)  
Obturador assimétrico (5u.)

60 ●

71-7895-60-00

71-7895-60-00

## Iris Proyector Superficie

## Iris Proyector Superficie Grande

**Accesorios ópticos**  
**Acessórios óticos**

Difusor elíptico (5u.)  
Difusor elíptico (5u.)

71-5167-00-00

71-5167-00-00



Difusor cuadrado (5u.)  
Difusor quadrado (5u.)

71-5658-00-00

71-5658-00-00



Difuminador de halo (5u.)  
Difusor opalino (5u.)

71-6099-00-00

71-6099-00-00



Panel de abeja (5u.)  
Painel de abelha (5u.)

60 ●

71-5166-60-00

71-5166-60-00



Apantallador (5u.)  
Obturador assimétrico (5u.)

60 ●

71-7895-60-00

71-7895-60-00



Plafón que puede utilizarse en su forma standard o de emergencia

Plafon que pode ser utilizado na sua forma standard ou de emergência

## Leco Standard

BODY MAT PC	DIF MAT PC		50000h L80 B20	3 MacAdam
----------------	---------------	--	-------------------	--------------

IP 44	IK 10	LOW FLICKER		
----------	----------	----------------	--	--

14

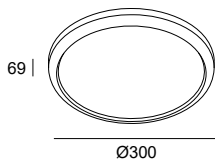

LED					
K	CRI	W Total	Real Lm	Code	
4000	80	10	911	15-A003 - 14 - OU	ON-OFF 220-240V



Leco emergency  
i P.000

---

# Luno Slim Surface

---



## Efecto tragaluz Efeito de claraboia

Luno Slim se integra en el espacio de forma sutil gracias a su perfil abombado, aportando una luz de calidad que evoca el efecto de un tragaluz.

Luno Slim, integra-se no espaço de forma subtil graças ao seu perfil abaulado, fornecendo uma luz de qualidade que evoca o efeito de uma claraboia.



---

Dos acabados y cuatro medidas para adaptarse a todos los proyectos  
Dois acabamentos e quatro medidas para se adaptar a todos os projetos





UGR<19.  
UGR<19.

Eficiencia de hasta 121 Lm/W  
Eficiência de até 121 Lm/W

Difusor microprismático de alta eficiencia.  
Difusor microprismático de alta eficiência.



# Luno Slim Surface

BODY MAT	DIF MAT		50000h	3
AL	PC		L80 B20	MacAdam

## Luno Slim Surface Small

	IP	UGR		
	20	<19		

Ejemplo de código / Exemplo de código: **AR11-27W9MPDS14**

Model	W	K / CRI/ Real lm	Optics	Source	Finishes
<b>AR11 -</b>  	<b>27</b> 27.8W	<b>W9</b> 3000K / CRI90 / 3037 lm	<b>MP</b> Microprisma	<b>DS</b> ON-OFF & DALI-2 220-240V	<b>14</b> <b>60</b>
		<b>X9</b> 4000K / CRI90 / 3158 lm			

## Luno Slim Surface Medium

	IP	UGR		
	20	<19		

Ejemplo de código / Exemplo de código: **AR12-37W9MPDS14**

Model	W	K / CRI/ Real lm	Optics	Source	Finishes
<b>AR12 -</b>  	<b>37</b> 37.8W	<b>W9</b> 3000K / CRI90 / 3956 lm	<b>MP</b> Microprisma	<b>DS</b> ON-OFF & DALI-2 220-240V	<b>14</b> <b>60</b>
		<b>X9</b> 4000K / CRI90 / 4114 lm			

## Luno Slim Surface Large

IP 20	NEW	UGR <16	LED	DRIVER
----------	-----	------------	-----	--------

Ejemplo de código / Exemplo de código: **AR13-72W9MPDS14**

Model	W	K / CRI/ Real lm	Optics	Source	Finishes
<b>AR13 -</b>  	<b>72</b> 71.3W	<b>W9</b> 3000K / CRI90 / 6917 lm	<b>MP</b> Microprisma	<b>DS</b>  ON-OFF & DALI-2 220-240V	<b>14</b>  <b>60</b> 
		<b>X9</b> 4000K / CRI90 / 7194 lm			

## Luno Slim Surface Extra Large

NEW	IP 20	UGR <16	LED	DRIVER
-----	----------	------------	-----	--------

Ejemplo de código / Exemplo de código: **AR14-CPW9MPDS14**

Model	W	K / CRI/ Real lm	Optics	Source	Finishes
<b>AR14 -</b>  	<b>CP</b> 108.2W	<b>W9</b> 3000K / CRI90 / 9863 lm	<b>MP</b> Microprisma	<b>DS</b>  ON-OFF & DALI-2 220-240V	<b>14</b>  <b>60</b> 
		<b>X9</b> 4000K / CRI90 / 10257 lm			

# Luno Surface

BODY MAT
AL

DIF MAT
PMMA



3
MacAdam



## Iluminación para grandes espacios Iluminação para grandes espaços

Luno es una colección de forma cilíndrica y líneas puras. Existen distintas versiones de instalación y tamaño, lo que se traduce en multitud de posibilidades en la iluminación de grandes espacios como auditorios, salas de conferencias, restaurantes o vestíbulos de hoteles.

Luno é uma coleção de forma cilíndrica e linhas puras. Existem diferentes versões de instalação e tamanho, o que se traduz numa infinidade de possibilidades na iluminação de grandes espaços como auditórios, salas de conferências, restaurantes ou átrios de hotéis.

### Luno Surface Ø400

IP
20

UGR
<22

50000h
L80 B20

WELL
------



○ ● ●  
14 60 DL\*

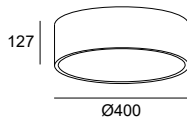

LED										
K	CRI	W Total	Real Lm	Code						
3000	80	27.5	2389	15-5922	DL	OU	ON-OFF	100-240V		
					- 14 -	RU	1-10V	100-240V		
						60				
4000	80	27.5	2389	15-5923	DL	OU	ON-OFF	100-240V		
					- 14 -	RU	1-10V	100-240V		
						60				

### Luno Surface Ø1200

IP
20

50000h
L80 B20

WELL
------



○ ● ●  
14 60 DL\*

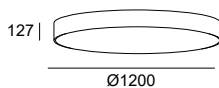

LED										
K	CRI	W Total	Real Lm	Code						
3000	80	161.3	15065	15-5928	DL	OU	ON-OFF	100-240V		
					- 14 -	RU	0-10V	100-240V		
						60				
4000	80	161.3	15065	15-5929	DL	OU	ON-OFF	100-240V		
					- 14 -	RU	0-10V	100-240V		
						60				

Controladores  
Controladores

P. 1166



CASAMBI  
IP20

71-5961-00-00

# Luno Surface

## Low UGR Microprismatic

BODY MAT	DIF MAT		3
AL	PMMA		MacAdam

INDOOR

### Luno Surface Low UGR Microprismatic Ø400

IP	LOW	WELL			
23	FLICKER				

○ ●  
14 60

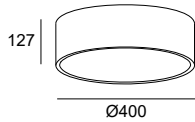

LED							
K	CRI	W Total	Real Lm	Code			
3000	80	27.5	2045	<b>15-7806</b>	- 14 - DS	DALI 220-240V	
4000	80	27.5	2045	<b>15-7807</b>	- 14 - DS	DALI 220-240V	
TW 2700-6500	90	28	1584	<b>15-7810</b>	- 14 - TW	DALI DT8 220-240V	

### Luno Surface Low UGR Microprismatic Ø600

IP	UGR	50000h	SWITCH CCT			
23	<19	L80 B20	2700-6500			

○ ●  
14 60

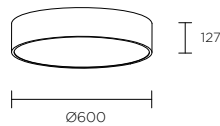

LED							
K	CRI	W Total	Real Lm	Code			
3000	80	59	4380	<b>15-7808</b>	- 14 - DS	1-10V/PUSH/DALI 220-240V	
4000	80	59	4380	<b>15-7809</b>	- 14 - DS	1-10V/PUSH/DALI 220-240V	
TW 2700-6500	90	51.7	4432	<b>15-7811</b>	- 14 - TW	DALI DT8 220-240V	

PROYECTORES / PLAFONES | PROJETOIRES / PLAFONS

Controladores  
Controladores

P. 1166



CASAMBI  
IP20

71-5961-00-00

# Ges



BODY MAT  
PLSTER



Colección fabricada en yeso, ideal para iluminación general de interiores con una integración total en el espacio

Coleção fabricada em gesso, ideal para a iluminação geral de interiores com uma integração total no espaço



## Ges Surfaced Round

IP
23

○  
14

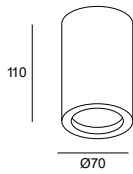

GU10	<b>Code</b>
<b>W</b>	<b>15-5946 - 14 - 00</b>
Max. 8	

# Play Deco

Designed by LedsC4 Architectural

EVOLUTION  
Essential  
EVOLUTION

BODY MAT  
AL

DIF MAT  
PMMA



50000h  
L80 B20

2  
MacAdam

INDOOR

## Eficiencia y confort Eficiência e conforto

Todas las prestaciones técnicas de la colección Play en una versión Surface, ideal para proyectos que requieren un plus de eficiencia y confort.

Todas as prestações técnicas da coleção Play numa versão Surface, ideal para projetos que requerem um plus de eficiência e conforto.



## Play Deco Spotlight

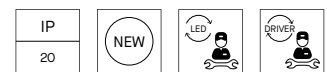

Ejemplo de código / Exemplo de código: **AG69-P7V9S20UWG**

Model	W	K / Cri / Real lm	Optics	Source	Finishes
 <b>AG69 -</b> IP20 	<b>P7</b> 8.6W	<b>V9</b> 2700K / CRI90 / 521 lm	<b>S2</b> 14°	<b>OU</b> ON-OFF 100-240V/50-60Hz	<b>WG</b> <b>WH</b> <b>WL</b> <b>WM</b> <b>WN</b> <b>WR</b>
		<b>W9</b> 3000K / CRI90 / 637 lm	<b>M2</b> 28°	<b>DU</b> DALI-2 110-277V/50-60Hz	
		<b>X9</b> 4000K / CRI90 / 642 lm	<b>F1</b> 49°	<b>TS</b> PHASE CUT 220-240V/50-60Hz	
	<b>13</b> 14.4W	<b>V9</b> 2700K / CRI90 / 1070 lm	<b>S2</b> 19°	<b>TS</b> PHASE CUT 220-240V/50-60Hz	
		<b>W9</b> 3000K / CRI90 / 1276 lm	<b>M2</b> 34°		
		<b>X9</b> 4000K / CRI90 / 1344 lm	<b>F1</b> 45°		

## Play Deco Surface

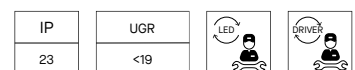

Ejemplo de código / Exemplo de código: **AG32-P7V9S20UWR**

Model	W	K / Cri / Real lm	Optics	Source	Finishes
 <b>AG32 -</b> Redondo / fijo Redondo / fixo IP23 	<b>P7</b> 8.5W	<b>V9</b> 2700K / CRI90 / 521 lm	<b>S2</b> 14°	<b>OU</b> ON-OFF 100-240V	<b>WR</b> <b>WG</b> <b>WH</b> <b>WL</b> <b>WM</b> <b>WN</b>
		<b>W9</b> 3000K / CRI90 / 637 lm	<b>M2</b> 28°	<b>TS</b> PHASE CUT 220-240V	
		<b>X9</b> 4000K / CRI90 / 642 lm	<b>F1</b> 49°	<b>DU</b> DALI-2 110-240V	
	<b>13</b> 14.3W	<b>V9</b> 2700K / CRI90 / 1070 lm	<b>S2</b> 19°	<b>OU</b> ON-OFF 100-240V	
		<b>W9</b> 3000K / CRI90 / 1276 lm	<b>M2</b> 34°	<b>TS</b> PHASE CUT 220-240V	
		<b>X9</b> 4000K / CRI90 / 1344 lm	<b>F1</b> 45°	<b>DU</b> DALI-2 110-240V	

## Drivers Driver

P. 1166



71-A260-00-00

PROYECTORES / PLAFONES | PROJETORES / PLAFONES



# Exit



Gran confort visual  
con un UGR > 19

Grande conforto visual  
com um UGR > 19

Plafón cilíndrico con una tecnología interior diseñada para ofrecer una alta reproducción de los colores en espacios y productos con un CRI 80/CRI 90, deslumbramiento mínimo y alto confort visual gracias a un UGR < 19.

Plafon cilíndrico com uma tecnologia interior projetada para oferecer uma alta reprodução de cores em espaços e produtos com um CRI 80/CRI 90, encadeamento mínimo e alto conforto visual graças a um UGR < 19.



BODY MAT	DIF MAT	50000h	2
AL	PC	L80 B20	MacAdam

IP	UGR			
23	<19			

○ ●  
14 60



LED									
K	CRI	W Total	Real Lm	Optics	Code				
3000	80	26.9	2284	38°	<b>90-3208</b>	- 14	- OU	ON-OFF 100-240V	
						- 60	- DU	DALI-2 100-240V	
3000	80	37.4	2646	38°	<b>90-3210</b>	- 14	- OU	ON-OFF 100-240V	
						- 60	- DU	DALI-2 100-240V	
3000	90	26.9	1728	38°	<b>90-3529</b>	- 14	- OU	ON-OFF 100-240V	
						- 60	- DU	DALI-2 100-240V	
3000	90	37.4	2347	38°	<b>90-3530</b>	- 14	- OU	ON-OFF 100-240V	
						- 60	- DU	DALI-2 100-240V	
4000	80	26.9	2284	38°	<b>90-3209</b>	- 14	- OU	ON-OFF 100-240V	
						- 60	- DU	DALI-2 100-240V	
4000	80	37.4	2646	38°	<b>90-3211</b>	- 14	- OU	ON-OFF 100-240V	
						- 60	- DU	DALI-2 100-240V	

## Controladores

P. 1166



CASAMBI  
IP20

**71-5961-00-00**

## Accesorios de fijación

Accesórios de fixação



Kit suspensión  
Kit suspensão

14 ○

**71-3223-14-00**

60 ●

**71-3223-60-00**

## Accesorios de conexión

Accesórios de conexão



Conector de carril  
Conetor de calha

60 ●

**71-3531-60-00**

# Multidir Evo Surface



Colección tipo cardan de superficie. Ideal para aplicaciones retail, tanto la versión individual como la doble, cuentan con un sistema mecánico de rotación que permite llevar la luz a cualquier punto y se presentan con interior en negro en todas las versiones, para una mayor integración y confort.

Coleção de superfície do cardan. Ideal para aplicativos de varejo, tanto a versão individual como o duplo, tem um sistema rotação mecânica que permite que a luz seja trazida para qualquer ponto e são apresentados com interior em preto em todas as versões, para maior integração e conforto.



# Multidir Small Single Ceiling

IP	
54	40°

INDOOR

Ejemplo de código / Exemplo de código: **AU16-P8V9S30S60**

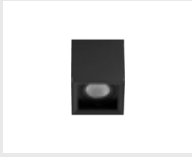
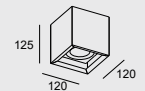
Model	W	K / CRI/ Real lm	Optics	Source	Finishes
<b>AU15 -</b> Simple / Superfície Simples / Superfície  	 <b>P8</b> 7.6W	<b>V9</b> 2700K / CRI90 / 863 lm	<b>S3</b> 17°	<b>OS</b> ON-OFF 220-240V	<b>60</b> <b>14</b> <b>34</b>
		<b>W9</b> 3000K / CRI90 / 860 lm	<b>M3</b> 24°	<b>DS</b> DALI-2 110-277V	
		<b>X9</b> 4000K / CRI90 / 854 lm	<b>F1</b> 64°	<b>BB</b> 30V/max.250mA	
	<b>11</b> 11.7W	<b>V9</b> 2700K / CRI90 / 1087 lm	<b>S3</b> 18°	<b>OU</b> ON-OFF 100-277V	
		<b>W9</b> 3000K / CRI90 / 1144 lm	<b>M3</b> 25°	<b>DS</b> DALI-2 110-277V	
		<b>X9</b> 4000K / CRI90 / 1141 lm	<b>F1</b> 64°	<b>XB</b> CSAMBI 220-240V	
	<b>AA</b> GU10	<b>G1</b>	<b>NA</b>	<b>BU</b> 100-240Vc	

# Multidir Small Double Ceiling

IP	
54	40°

PROYECTORES / PLAFONS  
PROYECTORES / PLAFONES

Ejemplo de código / Exemplo de código: **AU16-P8V9S30S60**

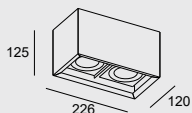
Model	W	K / CRI/ Real lm	Optics	Source	Finishes
<b>AU16 -</b> Doble / Superfície Duplo / Superfície  	 <b>P8</b> 2 x 7.6W (15.2W)	<b>V9</b> 2700K / CRI90 / 1739 lm	<b>S3</b> 17°	<b>OS</b> ON-OFF 220-240V	<b>60</b> <b>14</b> <b>34</b>
		<b>W9</b> 3000K / CRI90 / 1721 lm	<b>M3</b> 24°	<b>DS</b> DALI-2 110-277V	
		<b>X9</b> 4000K / CRI90 / 1708 lm	<b>F1</b> 64°	<b>BB</b> 30V/max.250mA	
	<b>11</b> 2 x 11.7W (23.4W)	<b>V9</b> 2700K / CRI90 / 2288 lm	<b>S3</b> 18°	<b>OU</b> ON-OFF 100-277V	
		<b>W9</b> 3000K / CRI90 / 2282 lm	<b>M3</b> 25°	<b>DS</b> DALI-2 110-277V	
		<b>X9</b> 4000K / CRI90 / 2282 lm	<b>F1</b> 64°	<b>XB</b> CASAMBI 220-240V	
	<b>AA</b> 2 x GU10	<b>G1</b>	<b>NA</b>	<b>BU</b> 100-240V	

\*El flujo lumínico indicado corresponde al ángulo central  
 O fluxo luminoso indicado corresponde ao ângulo central

# Multidir Big Single Ceiling

IP	
54	40°

Ejemplo de código / Exemplo de código: **AU22-18V9S3OU60**

Model	W	K / CRI/ Real lm	Optics	Source	Finishes
<b>AU22 -</b> Simple / Superficie Simples / Superfície	<b>18</b> 18.2W	<b>V9</b> 2700K / CRI90 / 1993 lm	<b>S3</b> 15°	<b>OU</b> ON-OFF 100-240V	<b>60</b> <b>14</b> <b>34</b>
		<b>W9</b> 3000K / CRI90 / 1971 lm	<b>M3</b> 23°	<b>DS</b> DALI-2 110-277V	
		<b>X9</b> 4000K / CRI90 / 2011 lm	<b>F1</b> 63°	<b>XB</b> CASAMBI 220-240V	
	<b>25</b> 25.4W	<b>V9</b> 2700K / CRI90 / 2715 lm	<b>S3</b> 14°	<b>OU</b> ON-OFF 100-240V	
		<b>W9</b> 3000K / CRI90 / 2735 lm	<b>M3</b> 23°	<b>DS</b> DALI-2 110-277V	
		<b>X9</b> 4000K / CRI90 / 2696 lm	<b>F1</b> 63°	<b>XB</b> CASAMBI 220-240V	
	<b>33</b> 33.3W	<b>V9</b> 2700K / CRI90 / 3409 lm	<b>S3</b> 14°	<b>OS</b> ON-OFF 220-240V	
		<b>W9</b> 3000K / CRI90 / 3439 lm	<b>M3</b> 23°	<b>DS</b> DALI-2 110-277V	
		<b>X9</b> 4000K / CRI90 / 3375 lm	<b>F1</b> 63°	<b>XB</b> CASAMBI 220-240V	
	<b>39</b> 37.5W	<b>V9</b> 2700K / CRI90 / 3891 lm	<b>S3</b> 15°	<b>OU</b> ON-OFF 100-240V	
		<b>W9</b> 3000K / CRI90 / 3968 lm	<b>M3</b> 23°	<b>DS</b> DALI-2/PUSH 220-240V	
		<b>X9</b> 4000K / CRI90 / 3878 lm	<b>F1</b> 63°	<b>XB</b> CASAMBI 220-240V	
<b>AA</b> GU10	<b>G1</b>	<b>NA</b>	<b>BU</b> 100-240V		

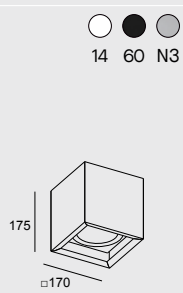

# Multidir Big Double Ceiling

BODY MAT	DIF MAT	50000h	2	IP	
AL	PC	L80 B20	MacAdam	54	40°





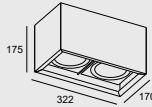

INDOOR

Ejemplo de código / Exemplo de código: **AU23-18V9S3OU60**

Model	W	K / CRI/ Real lm	Optics	Source	Finishes
<b>AU23 -</b> Doble / Superficie Duplo / Superficie  	<b>18</b> 2 x 18.2W (36.4W)	<b>V9</b> 2700K / CRI90 / 4017 lm	<b>S3</b> 15°	<b>OU</b> ON-OFF 100-240V	<b>60</b> <b>14</b> <b>34</b>
		<b>W9</b> 3000K / CRI90 / 3943 lm	<b>M3</b> 23°	<b>DS</b> DALI-2 110-277V	
		<b>X9</b> 4000K / CRI90 / 4022 lm	<b>F1</b> 63°	<b>XB</b> CASAMBI 220-240V <b>BB</b> 33V/max.500mA	
	<b>25</b> 2 x 25.4W (50.8W)	<b>V9</b> 2700K / CRI90 / 5469 lm	<b>S3</b> 14°	<b>OU</b> ON-OFF 100-240V	<b>60</b> <b>14</b> <b>34</b>
		<b>W9</b> 3000K / CRI90 / 5470 lm	<b>M3</b> 23°	<b>DS</b> DALI-2 110-277V	
		<b>X9</b> 4000K / CRI90 / 5391 lm	<b>F1</b> 63°	<b>XB</b> CASAMBI 220-240V <b>BB</b> 33V/max.700mA	
	<b>33</b> 2 x 33.3W (66.6W)	<b>V9</b> 2700K / CRI90 / 6867 lm	<b>S3</b> 14°	<b>OS</b> ON-OFF 220-240V	<b>60</b> <b>14</b> <b>34</b>
		<b>W9</b> 3000K / CRI90 / 6877 lm	<b>M3</b> 23°	<b>DS</b> DALI-2 110-277V	
		<b>X9</b> 4000K / CRI90 / 6750 lm	<b>F1</b> 63°	<b>XB</b> CASAMBI 220-240V <b>BB</b> 33V/max.900mA	
	<b>39</b> 2 x 37.5W (75W)	<b>V9</b> 2700K / CRI90 / 7838 lm	<b>S3</b> 15°	<b>OU</b> ON-OFF 100-240V	<b>60</b> <b>14</b> <b>34</b>
		<b>W9</b> 3000K / CRI90 / 7936 lm	<b>M3</b> 23°	<b>DS</b> DALI-2/PUSH 220-240V	
		<b>X9</b> 4000K / CRI90 / 7756 lm	<b>F1</b> 63°	<b>XB</b> CASAMBI 220-240V <b>BB</b> 33V/max.1050mA	
	<b>AA</b> 2 x GU10	<b>G1</b>	<b>NA</b>	<b>BU</b> 100-240V	

PROYECTORES / PLAFONES | PROJETORES / PLAFONS

\*El flujo lumínico indicado corresponde al ángulo central  
 O fluxo luminoso indicado corresponde ao ângulo central

		Multidir Small Single Ceiling 8W	Multidir Small Single Ceiling 11W	Multidir Small Single Ceiling GU10	Multidir Small Double Ceiling
<b>Drivers</b> Driver		P. 1166			
	ON-OFF IP20	-	71-6652-00-00	-	71-3542-00-00
	PHASE CUT 240V IP20	-	71-A297-00-00	-	-
	1-10V PUSH IP20	-	71-7710-00-00	-	71-4708-00-00
	1-10V DALI2 PUSH IP20	-	-	-	71-4706-00-00
	DALI2 IP20	71-B407-00-00	71-B407-00-00	-	-
	CASAMBI IP20	-	71-A260-00-00	-	-

### Accesorios ópticos







#### Acessórios óticos

	Panel de abeja (5u.) Painel de abelha (5u.)	60 ●	71-A854-60-00	71-A854-60-00	71-A854-60-00	71-A854-60-00
			Multidir Small Double Ceiling GU10	Multidir Big Single Ceiling 18W	Multidir Big Single Ceiling 25W	Multidir Big Single Ceiling 33W

### Drivers

#### Driver

P. 1166







	ON-OFF IP20	-	71-6142-00-00	71-6653-00-00	71-3542-00-00
	PHASE CUT 240V IP20	-	71-4898-00-00	71-A299-00-00	-
	1-10V PUSH IP20	-	71-7710-00-00	71-4708-00-00	71-4708-00-00
	1-10V DALI2 PUSH IP20	-	-	-	-
	DALI2 IP20	-	71-B407-00-00	71-A192-00-00	71-A303-00-00
	CASAMBI IP20	-	71-A260-00-00	71-A260-00-00	71-A260-00-00

### Accesorios ópticos

#### Acessórios óticos

	Panel de abeja (5u.) Painel de abelha (5u.)	60 ●	71-A854-60-00	71-A855-60-00	71-A855-60-00	71-A855-60-00
-------------------------------------------------------------------------------------	------------------------------------------------	------	---------------	---------------	---------------	---------------



		Multidir Big Single Ceiling 39W	Multidir Big Single Ceiling GU10	Multidir Big Double Ceiling	Multidir Big Double Ceiling GU10
<b>Drivers</b>					P. 1166
<b>Driver</b>					
	ON-OFF IP20	71-6661-00-00	-	71-3542-00-00	-
	PHASE CUT 240V IP20	-	-	-	-
	1-10V PUSH IP20	71-4708-00-00	-	71-4708-00-00	-
	1-10V DALI2 PUSH IP20	-	-	71-4706-00-00	-
	DALI2 IP20	71-A303-00-00	-	-	-
	CASAMBI IP20	71-A260-00-00	-	-	-

**Accesorios ópticos**  
Acessórios óticos

	Panel de abeja (5u.) Painel de abelha (5u.)	60 ●	71-A855-60-00	71-A855-60-00	71-A855-60-00	71-A855-60-00
-------------------------------------------------------------------------------------	------------------------------------------------	------	---------------	---------------	---------------	---------------

# Atom Surface

Designed by LedsC4 Architectural

FAMILIA/FAMILIA: Spotlights: P.000. Low Voltage: P.000.



Opción 8° para  
iluminación de acento y  
zoom manual  
Opção 8° para  
iluminação de realce e  
zoom manual

LED de alta eficiencia  
LED de alta eficiência



BODY MAT	50000h	2
AL	L80 B20	MacAdam

## Atom Surface 52 120V

IP 20	DIF MAT PC		WELL		320°		90°			120V
----------	---------------	--	------	--	------	--	-----	--	--	------

○ ● ● ●  
14 60 81 DN

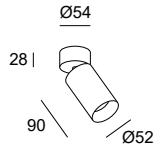

LED						
K	CRI	W Total	Real Lm	Optics	Code	
3000	90	7.5	361	24°	<b>15-6485</b>	<b>14</b>
3000	90	7.5	304	32°	<b>15-6486</b>	<b>60</b>
3000	90	7.5	259	43°	<b>15-6487</b>	<b>81</b>
						<b>DN</b>

**- ML PHASE CUT 120V**

## Atom Surface 52

IP 20	DIF MAT PC			90°		320°		
----------	---------------	--	--	-----	--	------	--	--

○ ● ● ●  
14 60 81 DN

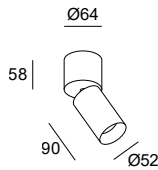

LED						
K	CRI	W Total	Real Lm	Optics	Code	
2700	90	15	853	20°	<b>15-A065</b>	<b>14</b>
2700	90	15	928	34°	<b>15-A066</b>	<b>60</b>
2700	90	15	778	45°	<b>15-A067</b>	<b>81</b>
2700	90	10.5	428	8°	<b>15-A095</b>	<b>DN</b>
3000	90	15	854	20°	<b>15-A068</b>	<b>14</b>
3000	90	15	928	34°	<b>15-A069</b>	<b>60</b>
3000	90	15	778	45°	<b>15-A070</b>	<b>81</b>
3000	90	10.5	437	8°	<b>15-A096</b>	<b>DN</b>
4000	90	15	981	20°	<b>15-A071</b>	<b>14</b>
4000	90	15	1067	34°	<b>15-A072</b>	<b>60</b>
4000	90	15	895	45°	<b>15-A073</b>	<b>81</b>
4000	90	10.5	459	8°	<b>15-A097</b>	<b>DN</b>

**- TS PHASE CUT 220-240V**

## Atom Surface 52 Zoom

IP 20	DIF MAT PC	LOW FLICKER			90°		320°		
----------	---------------	----------------	--	--	-----	--	------	--	--

○ ●  
14 60

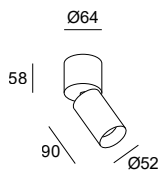

LED						
K	CRI	W Total	Real Lm	Optics	Code	
2700	90	15	518	Zoom 16° - 47°	<b>15-A098</b>	<b>14</b>
						<b>60</b>
3000	90	15	551	Zoom 16° - 47°	<b>15-A099</b>	<b>14</b>
						<b>60</b>
4000	90	15	577	Zoom 16° - 47°	<b>15-A100</b>	<b>14</b>
						<b>60</b>

**- TS PHASE CUT 220-240V**

### Atom Surface 75 36V

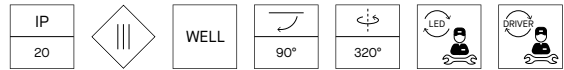

14 60

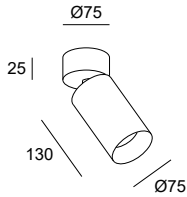

LED						max.700mA 36V	
K	CRI	W	Real Lm	Optics	Code		
2700	90	24	2367	23°	<b>15-7305</b>	<b>14</b>	<b>- 00</b>
2700	90	24	2291	31°	<b>15-7306</b>	<b>60</b>	<b>- 00</b>
2700	90	24	2355	39°	<b>15-7307</b>		
3000	90	24	2367	23°	<b>15-7308</b>	<b>14</b>	<b>- 00</b>
3000	90	24	2291	31°	<b>15-7309</b>	<b>60</b>	<b>- 00</b>
3000	90	24	2355	39°	<b>15-7310</b>		
4000	90	24	2722	23°	<b>15-A024</b>	<b>14</b>	<b>- 00</b>
4000	90	24	2635	31°	<b>15-A025</b>	<b>60</b>	<b>- 00</b>
4000	90	24	2708	39°	<b>15-A026</b>		

### Atom Surface 75 120V

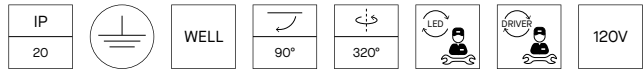

14 60

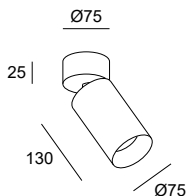

LED							
K	CRI	W Total	Real Lm	Optics	Code		
3000	90	14.3	1005	22°	<b>15-6282</b>	<b>14</b>	
3000	90	14.3	861	31°	<b>15-6283</b>	<b>60</b>	<b>- ML ON-OFF 120V</b>
3000	90	14.3	668	39°	<b>15-6284</b>		

### Atom Surface 75

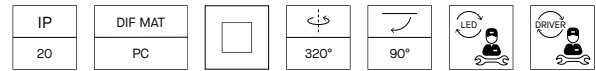

14 60

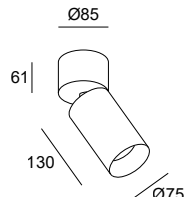

LED							
K	CRI	W Total	Real Lm	Optics	Code		
2700	90	28	2404	23°	<b>15-A083</b>	<b>14</b>	
2700	90	28	1991	31°	<b>15-A084</b>	<b>60</b>	<b>- DU DALI-2 120-240V</b>
2700	90	28	1567	39°	<b>15-A085</b>		
3000	90	28	2404	23°	<b>15-A086</b>	<b>14</b>	
3000	90	28	1991	31°	<b>15-A087</b>	<b>60</b>	<b>- DU DALI-2 120-240V</b>
3000	90	28	1567	39°	<b>15-A088</b>		
4000	90	28	2765	23°	<b>15-A080</b>	<b>14</b>	
4000	90	28	2290	31°	<b>15-A081</b>	<b>60</b>	<b>- DU DALI-2 120-240V</b>
4000	90	28	1802	39°	<b>15-A082</b>		

## Atom Surface 75 36V Zoom

IP
20



WELL

320°
------

90°
-----



14 60

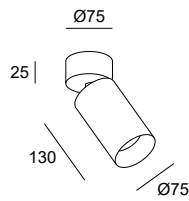

LED							max.350mA 36V	
K	CRI	W	Real Lm	Optics	Code			
2700	90	13.5	1634	Zoom 16° - 47°	<b>15-A018</b>	- <b>14</b>	- <b>60</b>	- <b>00</b>
3000	90	13.5	1667	Zoom 16° - 47°	<b>15-A019</b>	- <b>14</b>	- <b>60</b>	- <b>00</b>
4000	90	13.5	1751	Zoom 16° - 47°	<b>15-A020</b>	- <b>14</b>	- <b>60</b>	- <b>00</b>

## Atom Surface 75 Zoom

IP
20

DIF MAT
PC



320°
------

90°
-----



14 60

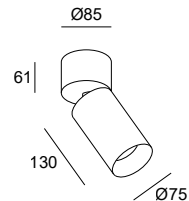







LED									
K	CRI	W Total	Real Lm	Optics	Code				
2700	90	16	1634	Zoom 16° - 47°	<b>15-A092</b>	- <b>14</b>	- <b>60</b>	- <b>DU</b> DALI-2 120-240V	
3000	90	16	1667	Zoom 16° - 47°	<b>15-A093</b>	- <b>14</b>	- <b>60</b>	- <b>DU</b> DALI-2 120-240V	
4000	90	16	1751	Zoom 16° - 47°	<b>15-A094</b>	- <b>14</b>	- <b>60</b>	- <b>DU</b> DALI-2 120-240V	

Atom Surface 52    Atom Surface 52 Zoom    Atom Surface 52 120V    Atom Surface 75









**Drivers**  
Driver

P. 1166

	ON-OFF IP20	-	-	-	-
	PHASE CUT 240V IP20	-	-	-	-
	1-10V PUSH IP20	-	-	-	-
	DALI2 IP20	-	-	-	-
	DALI2 PUSH IP20	-	-	-	-
	CASAMBI IP20	-	-	-	-

**Accesorios ópticos**  
Acessórios óticos

	Difusor elíptico (5u.) Difusor elíptico (5u.)		<b>71-6274-00-00</b>	<b>71-6274-00-00</b>	<b>71-6274-00-00</b>	<b>71-6280-00-00</b>
	Difuminador de halo (5u.) Difusor opalino (5u.)		<b>71-6275-00-00</b>	<b>71-6275-00-00</b>	<b>71-6275-00-00</b>	<b>71-6281-00-00</b>
	Conforto visual (1u.) Conforto visual (1u.)	14 ○	-	-	-	<b>71-6282-14-00</b>
		60 ●	<b>71-6276-60-00</b>	<b>71-6276-60-00</b>	<b>71-6276-60-00</b>	<b>71-6282-60-00</b>
	Panel de abeja (5u.) Painel de abelha (5u.)	60 ●	<b>71-6273-60-00</b>	<b>71-6273-60-00</b>	<b>71-6273-60-00</b>	<b>71-6279-60-00</b>
	Visera Viseira	60 ●	<b>71-6277-60-00</b>	<b>71-6277-60-00</b>	<b>71-6277-60-00</b>	<b>71-6283-60-00</b>
	Aro frontal Aro frontal	14 ○	<b>71-6436-14-00</b>	<b>71-6436-14-00</b>	<b>71-6436-14-00</b>	<b>71-6437-14-00</b>
		23 ●	<b>71-6436-23-00</b>	<b>71-6436-23-00</b>	<b>71-6436-23-00</b>	<b>71-6437-23-00</b>

Atom Surface  
75 ZoomAtom Surface  
75 36VAtom Surface  
75 36V ZoomAtom Surface  
75 120V

INDOOR

PROYECTORES / PLAFONES | PROJETOIRES / PLAFONS

327

**Drivers**  
Driver

P. 1166

	ON-OFF IP20	-	<b>71-6653-00-00</b> Min.1 - Max.1	<b>71-6652-00-00</b> Min.1 - Max.1	-
	PHASE CUT 240V IP20	-	<b>71-A299-00-00</b> Min.1 - Max.1	<b>71-A297-00-00</b> Min.1 - Max.1	-
	1-10V PUSH IP20	-	<b>71-4708-00-00</b> Min.1 - Max.2	<b>71-7710-00-00</b> Min.1 - Max.1	-
	DALI2 IP20	-	-	<b>71-B407-00-00</b>	-
	DALI2 PUSH IP20	-	<b>71-A192-00-00</b> Min.1 - Max.1	-	-
	CASAMBI IP20	-	<b>71-A260-00-00</b> Min.1 - Max.1	<b>71-A260-00-00</b> Min.1 - Max.1	-

**Accesorios ópticos**  
Acessórios óticos

	Difusor elíptico (5u.) Difusor elíptico (5u.)		<b>71-6280-00-00</b>	<b>71-6280-00-00</b>	<b>71-6280-00-00</b>	<b>71-6280-00-00</b>
	Difuminador de halo (5u.) Difusor opalino (5u.)		<b>71-6281-00-00</b>	<b>71-6281-00-00</b>	<b>71-6281-00-00</b>	<b>71-6281-00-00</b>
	Conforto visual (1u.) Conforto visual (1u.)	14 ○	<b>71-6282-14-00</b>	<b>71-6282-14-00</b>	<b>71-6282-14-00</b>	<b>71-6282-14-00</b>
		60 ●	<b>71-6282-60-00</b>	<b>71-6282-60-00</b>	<b>71-6282-60-00</b>	<b>71-6282-60-00</b>
	Panel de abeja (5u.) Painel de abelha (5u.)	60 ●	<b>71-6279-60-00</b>	<b>71-6279-60-00</b>	<b>71-6279-60-00</b>	<b>71-6279-60-00</b>
		60 ●	<b>71-6283-60-00</b>	<b>71-6283-60-00</b>	<b>71-6283-60-00</b>	<b>71-6283-60-00</b>
	Aro frontal Aro frontal	14 ○	<b>71-6437-14-00</b>	<b>71-6437-14-00</b>	<b>71-6437-14-00</b>	<b>71-6437-14-00</b>
		23 ●	<b>71-6437-23-00</b>	<b>71-6437-23-00</b>	<b>71-6437-23-00</b>	<b>71-6437-23-00</b>



# Atom Hide

Designed by LedsC4 Architectural

FAMILIA/FAMILIA: Spotlights: P.000. Low Voltage: P.000.



Proyector in-out que se presenta con tres medidas diferentes para adaptarse al espacio con facilidad

Projetor in-out que se apresenta em três medidas diferentes para se adaptar ao espaço com facilidade

De downlight a proyector en un solo paso

De downlight a projetor num único passo



BODY MAT	50000h	2
AL	L80 B20	MacAdam

## Atom Hide 32

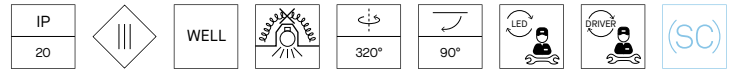

○ ●  
14 60

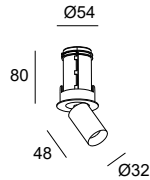

48 0-18 mm

LED						max.350mA 9V	
K	CRI	W	Real Lm	Optics	Code		
2700	90	3.1	269	37°	90-8013	14	00
						60	
3000	90	3.1	269	37°	90-8014	14	00
						60	

## Atom Hide 52 36V/350mA

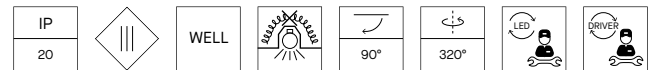

○ ● ● ●  
14 60 81 DN

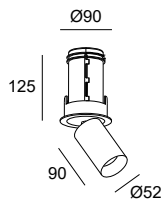

80 0-20 mm

LED						max.350mA 36V	
K	CRI	W	Real Lm	Optics	Code		
2700	90	12.1	1106	20°	90-7273	14	
2700	90	12.1	1230	34°	90-7274	60	00
2700	90	12.1	1234	45°	90-7275	81	
						DN	
3000	90	12.1	1106	20°	90-7276	14	
3000	90	12.1	1230	34°	90-7277	60	00
3000	90	12.1	1234	45°	90-7278	81	
						DN	
4000	90	12.1	1271	20°	90-A003	14	
4000	90	12.1	1414	34°	90-A004	60	00
4000	90	12.1	1418	45°	90-A005	81	
						DN	

### Atom Hide 52 12V/700mA

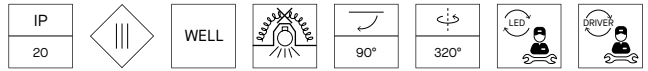

14 60 81 DN

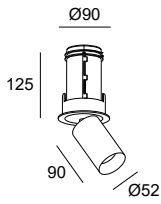

80 0-20 mm

LED max.700mA 12V

K	CRI	W	Real Lm	Optics	Code	
2700	90	8.2	428	8°	90-A021	14 60 81 DN - 00
3000	90	8.2	437	8°	90-A038	14 60 81 DN - 00
4000	90	8.2	459	8°	90-A039	14 60 81 DN - 00

### Atom Hide 52 36V/350mA Zoom

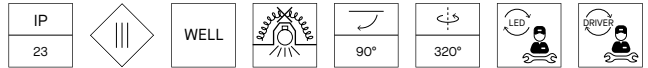

14 60

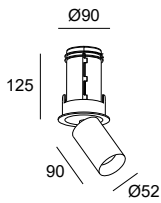

LED max.350mA 36V

K	CRI	W	Real Lm	Optics	Code	
2700	90	12.7	518	Zoom 16°-47°	90-A060	14 60 - 00
3000	90	12.7	551	Zoom 16°-47°	90-A061	14 60 - 00
4000	90	12.7	577	Zoom 16°-47°	90-A062	14 60 - 00

## Atom Hide 78

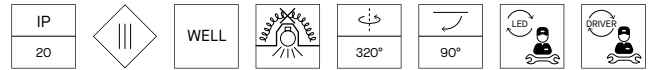

110 0-18 mm

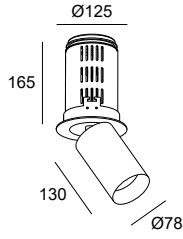

LED						max.700mA 36V	
K	CRI	W	Real Lm	Optics	Code		
2700	90	24	2367	23°	<b>90-8007</b>	<b>14</b>	<b>00</b>
2700	90	24	2291	31°	<b>90-8008</b>	<b>60</b>	<b>00</b>
2700	90	24	2355	39°	<b>90-8009</b>		
3000	90	24	2367	23°	<b>90-8010</b>	<b>14</b>	<b>00</b>
3000	90	24	2291	31°	<b>90-8011</b>	<b>60</b>	<b>00</b>
3000	90	24	2355	39°	<b>90-8012</b>		
4000	90	24	2722	23°	<b>90-A009</b>	<b>14</b>	<b>00</b>
4000	90	24	2635	31°	<b>90-A010</b>	<b>60</b>	<b>00</b>
4000	90	24	2708	39°	<b>90-A011</b>		

## Atom Hide 78 Zoom

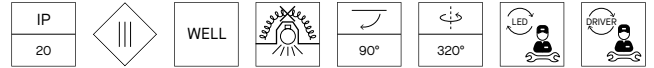

110 0-20 mm

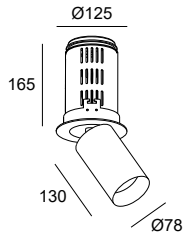

LED						max.350mA 36V	
K	CRI	W	Real Lm	Optics	Code		
2700	90	13.5	1634	Zoom 16°-47°	<b>90-A040</b>	<b>14</b>	<b>00</b>
3000	90	13.5	1667	Zoom 16°-47°	<b>90-A019</b>	<b>14</b>	<b>00</b>
4000	90	13.5	1751	Zoom 16°-47°	<b>90-A041</b>	<b>14</b>	<b>00</b>

Atom Hide 32

Atom Hide 52  
12V/700mAAtom Hide 52  
36V/350mA**Drivers**  
Driver

P. 1166

	ON-OFF IP20	<b>71-3542-00-00</b> Min.1 - Max.8	<b>71-B232-00-00</b> ✂ Min.1 - Max.1	<b>71-6652-00-00</b> ✂ Min.1 - Max.1
	PHASE CUT 240V IP20	<b>71-4898-00-00</b> Min.1 - Max.5	<b>71-7663-00-00</b> ✂ Min.1 - Max.1	<b>71-A297-00-00</b> ✂ Min.1 - Max.1
	1-10V PUSH IP20	<b>71-7710-00-00</b> Min.1 - Max.4	<b>71-7710-00-00</b> ✂ Min.1 - Max.2	<b>71-7710-00-00</b> ✂ Min.1 - Max.1
	DALI2 IP20	<b>71-6192-00-00</b> Min.1 - Max.4	<b>71-A190-00-00</b> ✂ Min.1 - Max.1	<b>71-B407-00-00</b>
	DALI D4i DALI2 IP20	-	-	-
	DALI2 PUSH IP20	-	-	<b>71-A191-00-00</b> ✂ Min.1 - Max.1
	CASAMBI IP20	<b>71-A260-00-00</b>	<b>71-A261-00-00</b> ✂ Min.1 - Max.3	<b>71-A260-00-00</b> ✂ Min.1 - Max.1

**Accesorios ópticos**  
Acessórios óticos

	Difusor elíptico (5u.) Difusor elíptico (5u.)	-	<b>71-6274-00-00</b>	<b>71-6274-00-00</b>	
	Difuminador de halo (5u.) Difusor opalino (5u.)	-	<b>71-6275-00-00</b>	<b>71-6275-00-00</b>	
	Conforto visual (1u.) Conforto visual (1u.)	14 ○	-	<b>71-6276-14-00</b>	<b>71-6276-14-00</b>
		60 ●	-	<b>71-6276-60-00</b>	<b>71-6276-60-00</b>
	Panel de abeja (5u.) Painel de abelha (5u.)	60 ●	-	<b>71-6273-60-00</b>	<b>71-6273-60-00</b>
		60 ●	-	<b>71-6277-60-00</b>	<b>71-6277-60-00</b>
	Aro frontal Aro frontal	14 ○	-	<b>71-6436-14-00</b>	<b>71-6436-14-00</b>
		23 ●	-	<b>71-6436-23-00</b>	<b>71-6436-23-00</b>

Atom Hide 52  
36V/350mA  
Zoom



Atom Hide 78



Atom Hide 78  
Zoom



INDOOR

**Drivers**  
Driver

P. 1166

	ON-OFF IP20	<b>71-6652-00-00</b>	<b>71-6653-00-00</b>	<b>71-6652-00-00</b>
		Min.1 - Max.1	Min.1 - Max.1	Min.1 - Max.1
	PHASE CUT 240V IP20	<b>71-A297-00-00</b>	<b>71-A299-00-00</b>	<b>71-A297-00-00</b>
		Min.1 - Max.1	Min.1 - Max.1	Min.1 - Max.1
	1-10V PUSH IP20	<b>71-7710-00-00</b>	<b>71-4708-00-00</b>	<b>71-7710-00-00</b>
		Min.1 - Max.1	Min.1 - Max.2	Min.1 - Max.1
	DALI2 IP20	<b>71-B407-00-00</b>	<b>71-A192-00-00</b>	<b>71-B407-00-00</b>
			Min.1 - Max.1	
	DALI D4i DALI2 IP20	-	<b>71-7737-00-00</b>	-
	DALI2 PUSH IP20	<b>71-A191-00-00</b>	-	<b>71-A191-00-00</b>
		Min.1 - Max.1		Min.1 - Max.1
	CASAMBI IP20	<b>71-A260-00-00</b>	<b>71-A261-00-00</b>	<b>71-A260-00-00</b>
		Min.1 - Max.1		Min.1 - Max.1

**Accesorios ópticos**  
Acessórios óticos

	Difusor elíptico (5u.) Difusor elíptico (5u.)	-	<b>71-6280-00-00</b>	<b>71-6280-00-00</b>	
	Difuminador de halo (5u.) Difusor opalino (5u.)	-	<b>71-6281-00-00</b>	<b>71-6281-00-00</b>	
	Conforto visual (1u.) Conforto visual (1u.)	14 ○	-	<b>71-6282-14-00</b>	<b>71-6282-14-00</b>
		60 ●	-	<b>71-6282-60-00</b>	<b>71-6282-60-00</b>
	Panel de abeja (5u.) Painel de abelha (5u.)	60 ●	-	<b>71-6279-60-00</b>	<b>71-6279-60-00</b>
	Visera Viseira	60 ●	-	<b>71-6283-60-00</b>	<b>71-6283-60-00</b>
	Aro frontal Aro frontal	14 ○	-	<b>71-6437-14-00</b>	<b>71-6437-14-00</b>
		23 ●	-	<b>71-6437-23-00</b>	<b>71-6437-23-00</b>

PROYECTORES / PLAFONES | PROJETORES / PLAFONS

# Atom Recessed

Designed by LedsC4 Architectural

FAMILIA/FAMILIA: Spotlights: P.000. Low Voltage: P.000.

Todas las ventajas de la  
colección Atom en la  
novedad recessed  
Todas as vantagens  
da coleção Atom na  
novidade recessed





## Atom Recessed 30mm

IP 20	NEW	DIF MAT PC						
----------	-----	---------------	--	--	--	--	--	--

14 60 81 DN

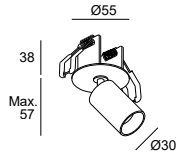

48 0-18 mm

LED							max.350mA 9V	
K	CRI	W	Real Lm	Optics	Code			
2700	90	3.1	269	37°	35-A139	14	60	- 00
						81	DN	
						14	60	
						81	DN	
3000	90	3.1	269	37°	35-A140	14	60	- 00
						81	DN	
						14	60	
						81	DN	

## Atom Recessed 52mm

NEW	IP 20	DIF MAT PC						
-----	----------	---------------	--	--	--	--	--	--

14 60 81 DN

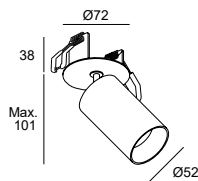

65 0-20 mm

LED							max.700mA 12V	
K	CRI	W	Real Lm	Optics	Code			
2700	90	8.2	428	8°	35-A141	14		
2700	90	12.1	853	20°	35-A142	60	- 00	
2700	90	12.1	928	34°	35-A143	81		
2700	90	12.1	778	45°	35-A144	DN		
3000	90	8.2	437	8°	35-A146	14		
3000	90	12.1	853	20°	35-A147	60	- 00	
3000	90	12.1	928	34°	35-A148	81		
3000	90	12.1	778	45°	35-A149	DN		
4000	90	8.2	459	8°	35-A151	14		
4000	90	12.1	981	20°	35-A152	60	- 00	
4000	90	12.1	1067	34°	35-A153	81		
4000	90	12.1	895	45°	35-A154	DN		

## Atom Recessed 52mm Zoom

IP 20	NEW	DIF MAT PC						
----------	-----	---------------	--	--	--	--	--	--

14 60

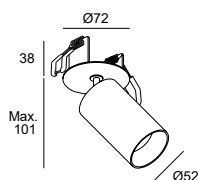

65 0-20 mm

LED							max.350mA 36V	
K	CRI	W	Real Lm	Optics	Code			
2700	90	12.7	518	Zoom 16°-47°	35-A145	14	- 00	
						60		
3000	90	12.7	551	Zoom 16°-47°	35-A150	14	- 00	
						60		
4000	90	12.7	577	Zoom 16°-47°	35-A155	14	- 00	
						60		

Atom Recessed 30mm

Atom Recessed 52mm



## Drivers

### Driver

P. 1166



CASAMBI  
IP20

71-A260-00-00

71-A260-00-00

## Accesorios ópticos

### Acessórios óticos



Difusor elíptico (5u.)  
Difusor elíptico (5u.)

-

71-6274-00-00



Difuminador de halo (5u.)  
Difusor opalino (5u.)

-

71-6275-00-00



Conforto visual (1u.)  
Conforto visual (1u.)

14 ○

-

71-6276-14-00

60 ●

-

71-6276-60-00



Panel de abeja (5u.)  
Painel de abelha (5u.)

60 ●

-

71-6273-60-00



Visera  
Viseira

60 ●

-

71-6277-60-00



Aro frontal  
Aro frontal

14 ○

-

71-6436-14-00

23 ●

-

71-6436-23-00

# Bento Surface

Designed by LedsC4 Architectural

INDOOR

**FAMILIA/FAMILIA:** Low Voltage: P.000, Downlights: P.000, Emergency: P.000.



Esta opción está pensada para techos con dificultad para empotrar. Presenta las mismas características de la colección Bento, en un formato superficie. Con opción de 3, 6 y 12 ópticas, ofrece una luz totalmente homogénea con un rango de apertura del ángulo de luz que va de Spot (15°) a Flood (50°).

Esta opção foi pensada para tetos com dificuldade de encastrar. Apresenta as mesmas características da coleção Bento, num formato superfície. Com opções de 3, 6 e 12 óticas, oferece uma luz totalmente homogénea com um intervalo de abertura do ângulo de luz que vai de Spot (15°) a Flood (50°).

Distintas opciones  
y acabados  
Diferentes opções  
e acabamentos

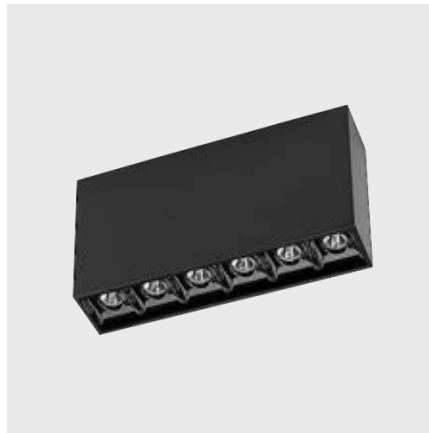

Bento Surface se presenta con opción de caja en color blanco y negro.  
Bento Surface apresenta-se com opção de cor branca e preta.

PROYECTORES / PLAFONES | PROJETORES / PLAFONS

# Bento Surface

BODY MAT	50000h	3
AL	L80 B20	MacAdam

## Bento Surface 3 LEDS Not Driver

IP	UGR		WELL		
23	<13				

○ ●  
14 60

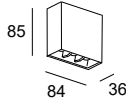

LED						max.700mA 9V	
K	CRI	W	Real Lm	Optics	Code		
2700	90	6.1	560	18°	<b>15-7098</b>	- 14 - 60	
2700	90	6.1	638	38°	<b>15-7099</b>		
2700	90	6.1	603	47°	<b>15-7100</b>		
3000	90	6.1	560	18°	<b>15-7101</b>	- 14 - 60	
3000	90	6.1	638	38°	<b>15-7161</b>		
3000	90	6.1	603	47°	<b>15-7169</b>		
4000	90	6.1	609	18°	<b>15-7184</b>	- 14 - 60	
4000	90	6.1	693	38°	<b>15-7185</b>		
4000	90	6.1	655	47°	<b>15-7186</b>		

## Bento Surface 3 LEDS

	IP	UGR			
	23	<16			

○ ●  
14 60

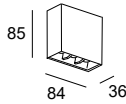

LED							
K	CRI	W Total	Real Lm	Optics	Code		
2700	90	8	560	16	<b>15-7098</b>	- 14 - OS	ON-OFF 220-240V
2700	90	8	638	38	<b>15-7099</b>		
2700	90	8	603	48	<b>15-7100</b>		
3000	90	8	560	16	<b>15-7101</b>	- 14 - OS	ON-OFF 220-240V
3000	90	8	638	38	<b>15-7161</b>		
3000	90	8	603	48	<b>15-7169</b>		
4000	90	8	609	16	<b>15-7184</b>	- 14 - OS	ON-OFF 220-240V
4000	90	8	693	38	<b>15-7185</b>		
4000	90	8	655	48	<b>15-7186</b>		

**Bento Surface 6 LEDs**

IP	UGR		
23	<13		

○ ●  
14 60

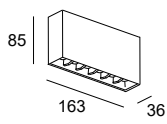

LED									
K	CRI	W Total	Real Lm	Optics	Code				
2700	90	16.1	1119	18°	<b>15-7187</b>	- 14 -	- MS -	PHASE CUT 220-240V	
2700	90	16.1	1276	38°	<b>15-7188</b>				
2700	90	16.1	1205	47°	<b>15-7189</b>	- 60 -	- DS -	DALI-2 220-240V	
3000	90	16.1	1119	18°	<b>15-7190</b>	- 14 -	- MS -	PHASE CUT 220-240V	
3000	90	16.1	1276	38°	<b>15-7191</b>				
3000	90	16.1	1205	47°	<b>15-7192</b>	- 60 -	- DS -	DALI-2 220-240V	
4000	90	16.1	1216	18°	<b>15-7193</b>	- 14 -	- MS -	PHASE CUT 220-240V	
4000	90	16.1	1387	38°	<b>15-7194</b>				
4000	90	16.1	1310	47°	<b>15-7195</b>	- 60 -	- DS -	DALI-2 220-240V	

**Bento Surface 12 LEDs**

IP	UGR		
23	<13		

○ ●  
14 60

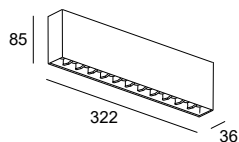

LED									
K	CRI	W Total	Real Lm	Optics	Code				
2700	90	26.5	2240	18°	<b>15-7196</b>	- 14 -	- MS -	PHASE CUT 220-240V	
2700	90	26.5	2552	38°	<b>15-7197</b>				
2700	90	26.5	2412	47°	<b>15-7198</b>	- 60 -	- DS -	DALI-2 220-240V	
3000	90	26.5	2240	18°	<b>15-7199</b>	- 14 -	- MS -	PHASE CUT 220-240V	
3000	90	26.5	2552	38°	<b>15-7200</b>				
3000	90	26.5	2412	47°	<b>15-7201</b>	- 60 -	- DS -	DALI-2 220-240V	
4000	90	26.5	2435	18°	<b>15-7202</b>	- 14 -	- MS -	PHASE CUT 220-240V	
4000	90	26.5	2774	38°	<b>15-7203</b>				
4000	90	26.5	2622	47°	<b>15-7204</b>	- 60 -	- DS -	DALI-2 220-240V	

# Bento IP66

Designed by LedsC4 Architectural

FAMILIA/FAMILIA: Low Voltage: P.000, Downlights: P.000, Emergency: P.000.



La familia Bento IP66 se ofrece en versión superficie y diferentes acabados

A família Bento IP66 está disponível nas versões encastrada e de superfície, e diferentes acabamentos

## Full IP66

Protección full IP66 que permite instalar la luminaria en espacios donde haya humedad o exposición al polvo y al agua.

Proteção full IP66 que permite a instalação da luminária em espaços com humidade ou exposição ao pó e à água.



**Bento Surface 6 LEDS IP66**

IP 66	NEW	IK 09	UGR <13	DIF MAT GLA		SEA SIDE SUITABLE		
----------	-----	----------	------------	----------------	--	----------------------	--	--

Z5\* 14\* 60\* 34\* J6\* E3\* DL\*

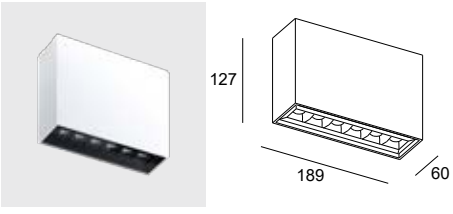

LED									
K	CRI	W Total	Real Lm	Optics	Code				
						Z5			
						J6			
2700	90	14.7	1119	18°	15-A116	E3	OU	ON-OFF	100-277V
2700	90	14.7	1276	38°	15-A117	- DL -	DS	DALI-2	220-240V
2700	90	14.7	1205	47°	15-A118	14			
						60			
						34			
						Z5			
						J6			
3000	90	14.7	1119	18°	15-A119	E3	OU	ON-OFF	100-277V
3000	90	14.7	1276	38°	15-A120	- DL -	DS	DALI-2	220-240V
3000	90	14.7	1205	47°	15-A121	14			
						60			
						34			
						Z5			
						J6			
4000	90	14.7	1216	18°	15-A122	E3	OU	ON-OFF	100-277V
4000	90	14.7	1387	38°	15-A123	- DL -	DS	DALI-2	220-240V
4000	90	14.7	1310	47°	15-A124	14			
						60			
						34			



# Kiva Surface

Designed by LedsC4 Architectural

FAMILIA/FAMILIA: Low Voltage: P.000, Downlights: P.000



## Funcionalidad y estética en una misma solución Funcionalidade e estética numa única solução

La colección Kiva viene ampliada con nuevas funcionalidades, pensadas para aportar iluminación a cualquier espacio con facilidad gracias a su rotación 180°.

A coleção Kiva foi ampliada com novas funcionalidades, pensadas para proporcionar iluminação a qualquer espaço com facilidade graças à sua rotação 180°.



## Kiva Surface 75mm

	IP 20	LOW FLICKER	 90°	 360°		
--	----------	----------------	---------	----------	--	--

14 60 81 DN

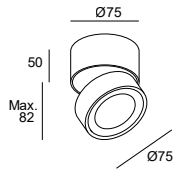

LED									
K	CRI	W	Total	Real	Lm	Optics	Code		
2700	90	7.8	458	19°	15-8035	14 60 81 DN	- MS	PHASE CUT	220-240V
3000	90	7.8	530	19°	15-8036	14 60 81 DN	- MS	PHASE CUT	220-240V

## Kiva Surface 95mm

	IP 20	 90°	 360°		
--	----------	---------	----------	--	--

14 60 81 DN

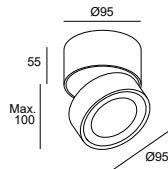

LED									
K	CRI	W	Total	Real	Lm	Optics	Code		
2700	90	13.2	1172	23°	15-8037	14 60 81 DN	- MS - DS	PHASE CUT	220-240V DALI-2 120-240V
3000	90	13.2	1320	23°	15-8038	14 60 81 DN	- MS - DS	PHASE CUT	220-240V DALI-2 120-240V

# Sistemas Lineales

# Sistemas Lineales

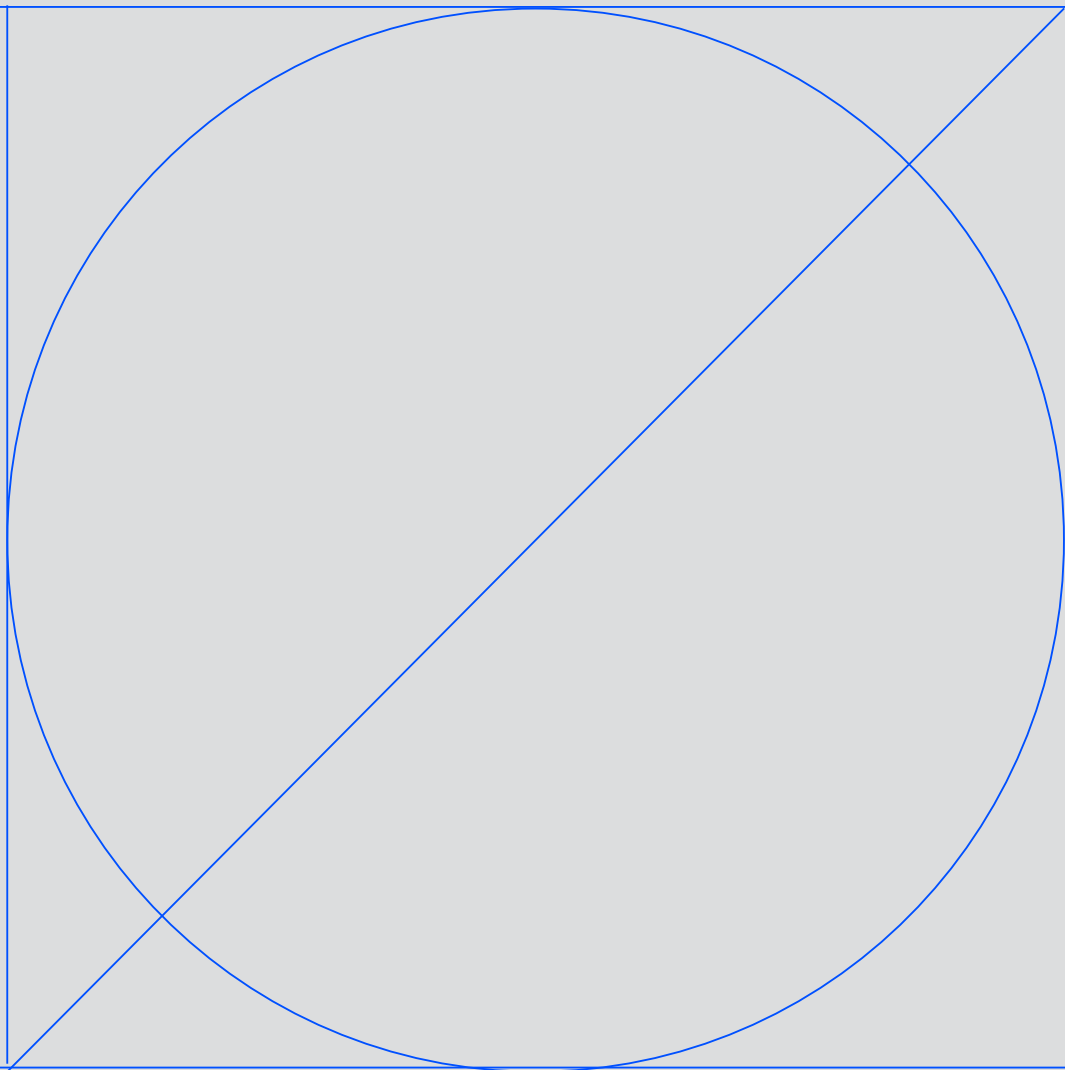
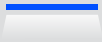

Apex

344

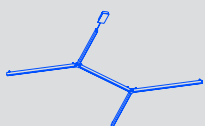

Infinite Pro

364



Infinite Slim

402

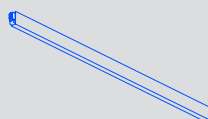

Lineal

408

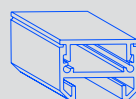

Taglio di luce

410

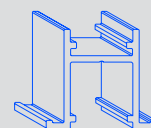

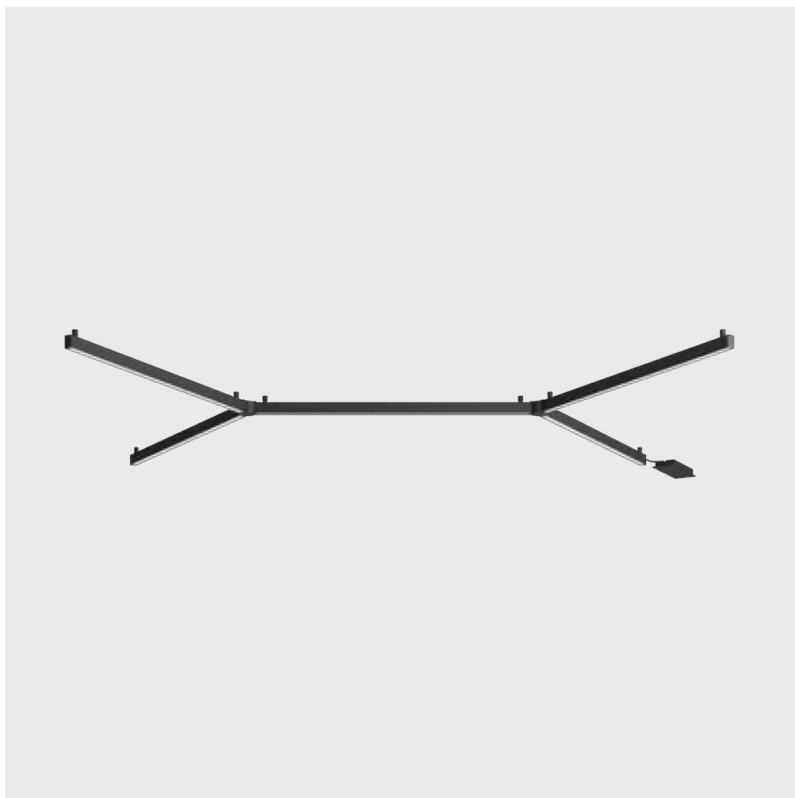

## Apex desafía la dimensionalidad del espacio con sus geometrías ilimitadas

## Apex desafía a dimensionalidade do espaço com as suas geometrias

Los espacios comunican a través de la composición de sus elementos. Apex es una solución flexible, con una estructura viva que se adapta sin límites a la imaginación de arquitectos y diseñadores. Sus construcciones pueden ser sencillas, con una única fuente de luz, o bien complejas, formando distintas figuras geométricas gracias a la concatenación de su sistema.

Os espaços comunicam através da composição dos seus elementos. Apex é uma solução flexível, com uma estrutura viva que se adapta sem limites à imaginação de arquitetos e designers. As suas construções podem ser simples, com uma única fonte de luz, ou complexas, formando diferentes figuras geométricas graças à concatenação do seu sistema.







Diferentes perfiles y elementos constructivos para generar distintas composiciones en instalaciones suspendidas o de superficie  
 Diferentes perfis e elementos construtivos para criar diferentes composições em instalações suspensas ou de superfície

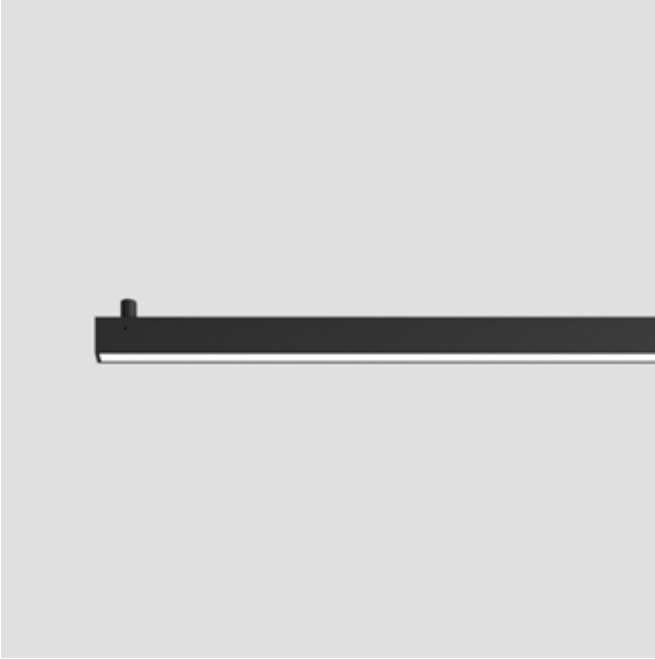

Perfil lineal.  
 Perfil Linear.



Perfil arco.  
 Perfil Arco.

Nodos de hasta 6 salidas  
 Nós de até 6 saídas



Nodo 4.  
 Nó 4.

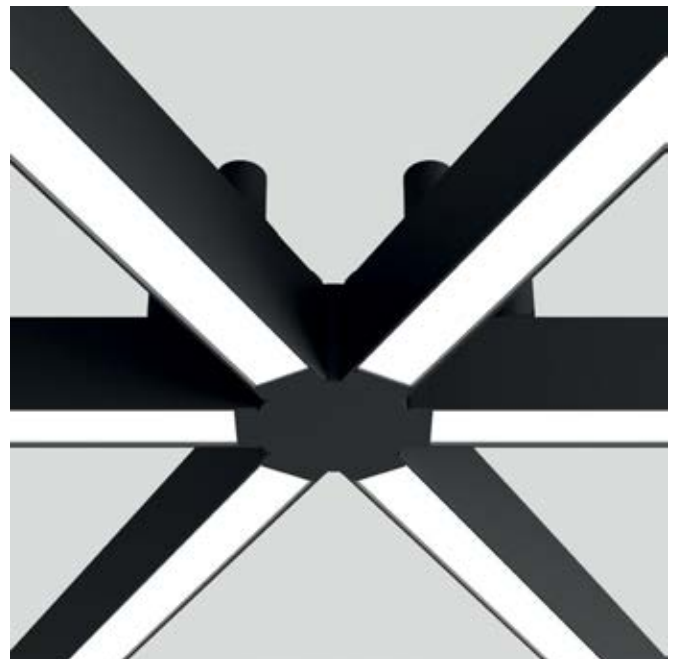

Nodo 6.  
 Nó 6.



# Instalación y versatilidad

## Instalação e versatilidade

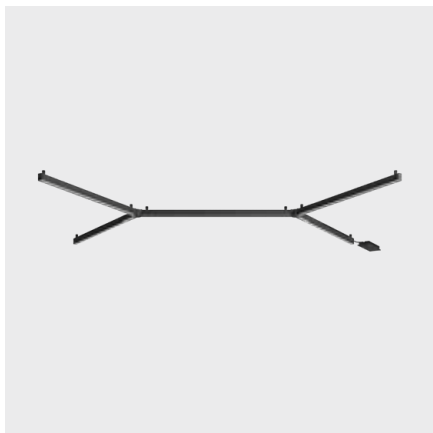
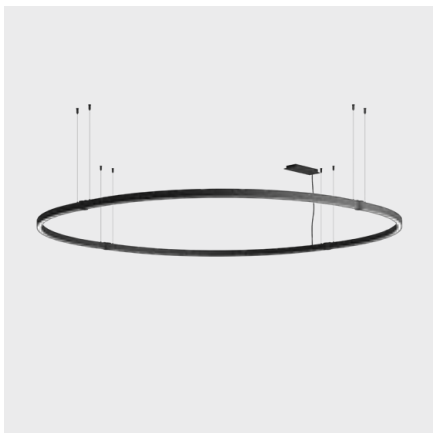
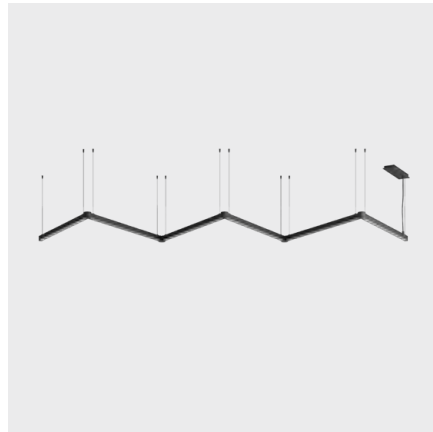
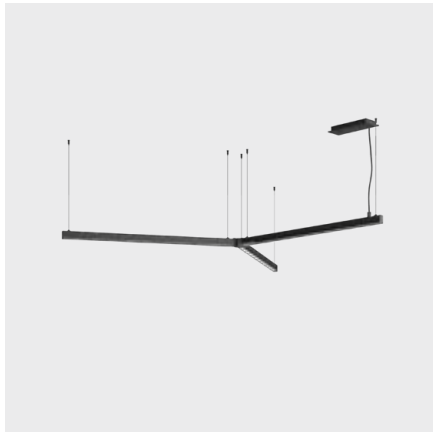
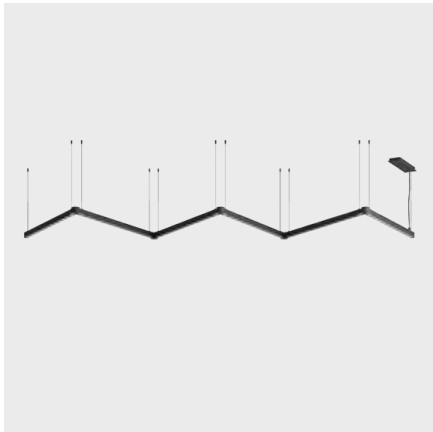
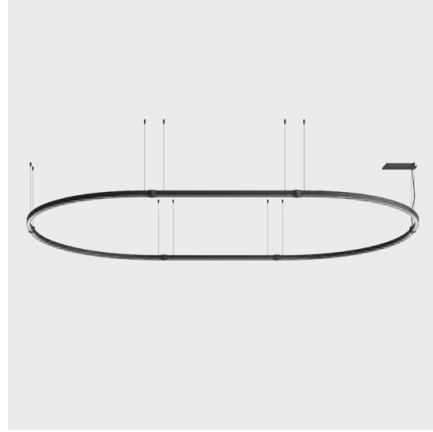



Una óptica para cada necesidad  
 Una óptica para cada necesidad

**Opal**

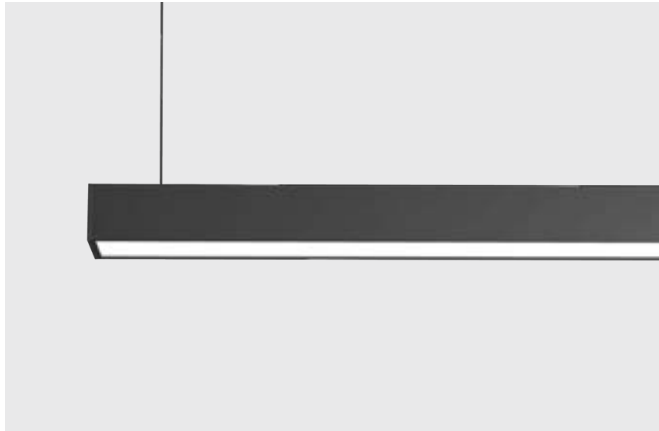

Iluminación difusa  
 Iluminação difusa

**Bento UGR < 16**

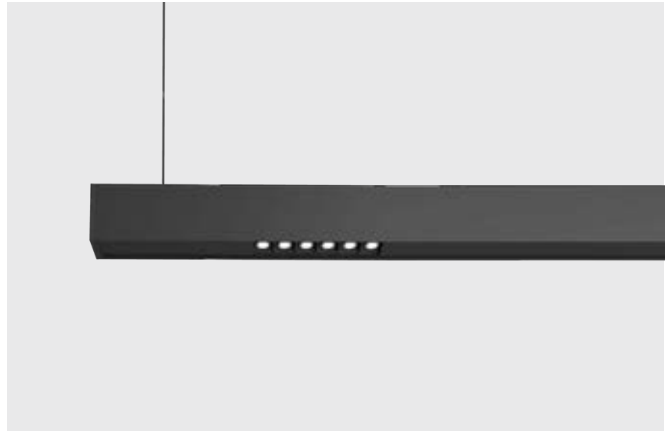

Ángulo controlado de 52°  
 Ângulo controlado de 52°



Spot 30 mm

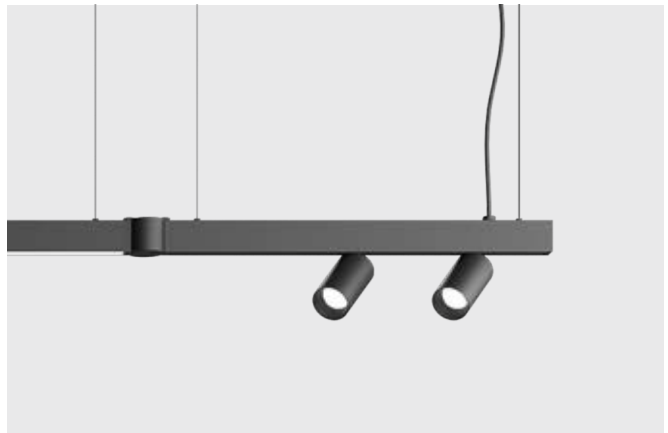

Spot 52 mm

**Tipo de florón**  
 Tipo de florão

**Superficie**  
Superfície

**Empotrado**  
Encastrado

**Equipo remoto\***  
Equipo remoto\*

\*Para esta instalación es necesario el acceso posterior  
 \*O acesso traseiro é necessário para esta instalação.

W	M/sección cable 1,5 mm <sup>2</sup> * Metros - por secção cabo 1,5 mm <sup>2</sup>	M/sección cable 2,5 mm <sup>2</sup> * Metros - por secção cabo 2,5 mm <sup>2</sup>
75	18	30
120	14	20
180	8	15
240	5	13

\*Distancia máxima entre el florón empotrado mini y el equipo según la sección del cable.  
 \*Distância máxima entre a mini capota de encastrar e o equipamento em função da secção do cabo.



**Apex H (AW35)** en oficinas Fuego Camina Conmigo. Barcelona. Fotografía: Enric Badrinas.  
**Apex H (AW35)** em escritórios Fuego Camina Conmigo. Barcelona. Fotografía: Enric Badrinas.

## Smart Casambi Bluetooth incorporado

### Smart Casambi Bluetooth incorporado

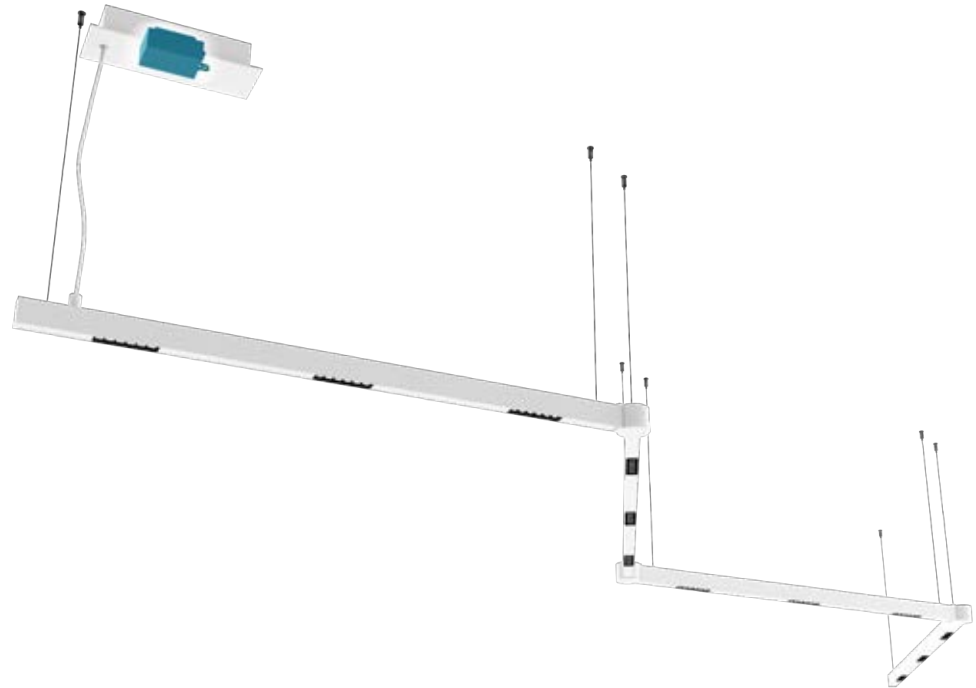
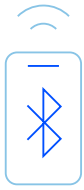

Las opciones con Casambi Bluetooth incorporado permiten acceder a funcionalidades Smart de forma muy fácil y rápida.

As opções com Casambi Bluetooth incorporado permitem o acesso à funcionalidade Smart de forma fácil e rápida.

La regulación del nivel lumínico en función del uso del espacio (presencia humana) se traduce en un gran ahorro energético

A regulação do nível de luz de acordo com o uso do espaço (presença humana) se traduz em grande economia de energia





Opciones de configuración infinitas de forma fácil y rápida gracias nuestro configurador online.

Opções de configuração infinitas de uma forma rápida e fácil, graças ao nosso configurador online.

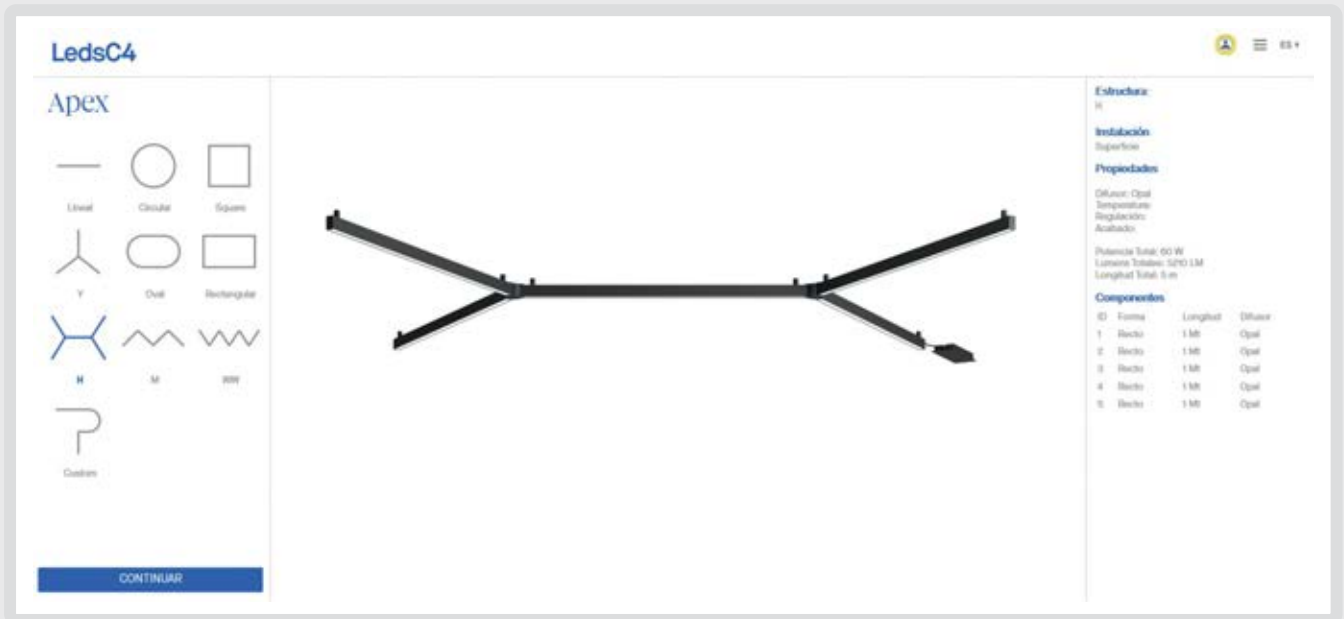

## 1 Selección de forma Seleção da forma

Posibilidad de elección entre configuración Standard o Custom.  
Escolha de configuração Standard ou Personalizada.

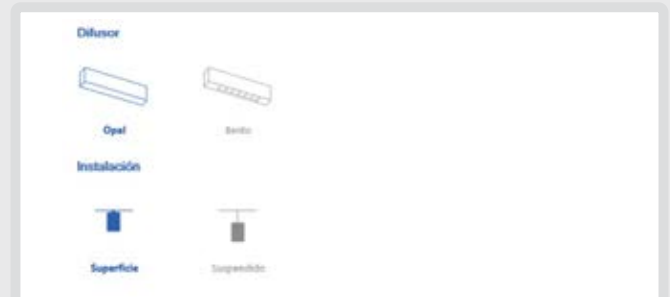

## 2 Selección de tamaño, difusor e instalación Escolha de tamanho, difusor e instalação

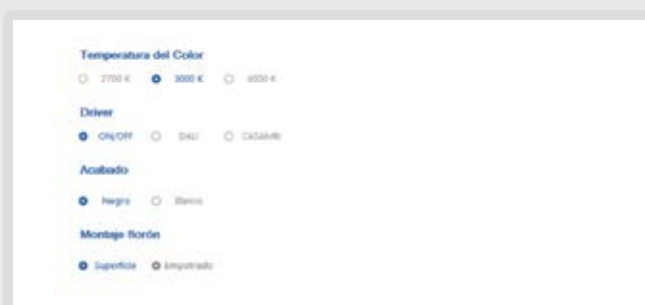

## 3 Selección de temperatura de color, ajuste y acabado Escolha da temperatura de cor, configuração e acabamento











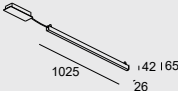

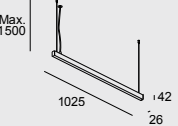
## 4 Descarga de documentación Descarregar documentação

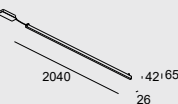

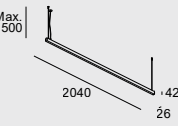
## Apex Lineal Simple

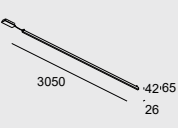

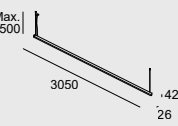
Ejemplo de código / Exemplo de código: **AW11-12VAPLOS14**

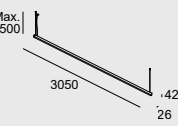
Model	W	K / CRI / Real lm	Optics	Source	Finishes
  <b>AW11 -</b> Lineal / Surface / 1000mm IP40	<b>12</b> 13.2W	<b>VA</b> 2700K / CRI 90 / 1042 lm	<b>PL</b> Opal	<b>OS</b> ON-OFF 220-240V	<b>14</b> <b>60</b>
		<b>WA</b> 3000K / CRI 90 / 1042 lm			
<b>XA</b> 4000K / CRI 90 / 1042 lm	<b>BE</b> Bento 52	<b>DS</b> DALI 220-240V			
<b>V9</b> 2700K / CRI 90 / 1563 lm		<b>DR</b> DALI Remote 220-240V			
  <b>AW14 -</b> Lineal / Pendant / 1000mm IP20	<b>18</b> 22.1W	<b>W9</b> 3000K / CRI 90 / 1563 lm	<b>XB</b> CASAMBI 220-240V		
		<b>X9</b> 4000K / CRI 90 / 1563 lm	<b>XR</b> CASAMBI Remote 220-240V		
  <b>AW12 -</b> Lineal / Surface / 2000mm IP40	<b>24</b> 26.4W	<b>VA</b> 2700K / CRI 90 / 2084 lm	<b>PL</b> Opal	<b>OS</b> ON-OFF 220-240V	
		<b>WA</b> 3000K / CRI 90 / 2084 lm		<b>OR</b> ON-OFF Remote 220-240V	
  <b>AW15 -</b> Lineal / Pendant / 2000mm IP20	<b>36</b> 42.2W	<b>XA</b> 4000K / CRI 90 / 2084 lm	<b>BE</b> Bento 52	<b>DS</b> DALI 220-240V	
		<b>V9</b> 2700K / CRI 90 / 3126 lm		<b>DR</b> DALI Remote 220-240V	
  <b>AW13 -</b> Lineal / Surface / 3000mm IP40	<b>36</b> 39.6W	<b>W9</b> 3000K / CRI 90 / 3126 lm	<b>PL</b> Opal	<b>XB</b> CASAMBI 220-240V	
		<b>X9</b> 4000K / CRI 90 / 3126 lm		<b>XR</b> CASAMBI Remote 220-240V	
  <b>AW16 -</b> Lineal / Pendant / 3000mm IP20	<b>54</b> 63.2W	<b>V9</b> 2700K / CRI 90 / 4689 lm	<b>BE</b> Bento 52	<b>DR</b> DALI Remote 220-240V	
		<b>W9</b> 3000K / CRI 90 / 4689 lm		<b>XB</b> CASAMBI 220-240V	
  <b>AW16 -</b> Lineal / Pendant / 3000mm IP20	<b>54</b> 63.2W	<b>X9</b> 4000K / CRI 90 / 4689 lm	<b>BE</b> Bento 52	<b>XR</b> CASAMBI Remote 220-240V	



# Apex Lineal Double Spot Small

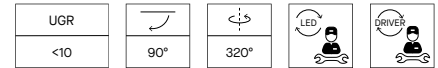

Ejemplo de código / Exemplo de código: **AW42-18VAPLOS14**

INDOOR

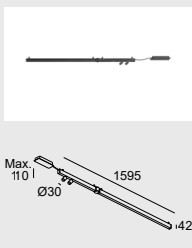
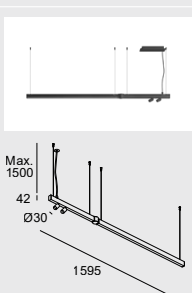
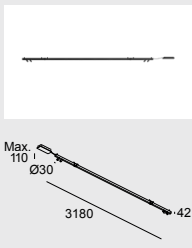
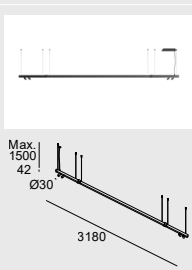
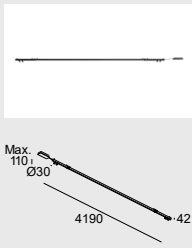
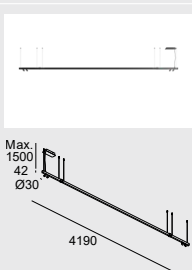
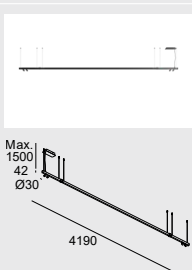
Model	W	K / CRI / Real lm	Optics	Source	Finishes
<b>AW42 -</b> Lineal / Surface / 1595mm / 2 Spots 30mm IP40 ▷90° ◂320° 	<b>18</b> 19.8W	<b>VA</b> 2700K / CRI 90 / 1770 lm	<b>PL</b> Opal	<b>OS</b> ON-OFF 220-240V	<b>14</b> <b>60</b>
		<b>WA</b> 3000K / CRI 90 / 1770 lm		<b>OR</b> ON-OFF Remote 220-240V	
<b>XA</b> 4000K / CRI 90 / 1770 lm	<b>BE</b> Bento 52	<b>DS</b> DALI 220-240V			
<b>V9</b> 2700K / CRI 90 / 2291 lm		<b>DR</b> DALI Remote 220-240V			
<b>AW45 -</b> Lineal / Pendant / 1595mm / 2 Spots 30mm IP20 ▷90° ◂320° 	<b>24</b> 30W	<b>W9</b> 3000K / CRI 90 / 2537 lm	<b>XB</b> CASAMBI 220-240V		
		<b>X9</b> 4000K / CRI 90 / 2291 lm	<b>XR</b> CASAMBI Remote 220-240V		
<b>AW43 -</b> Lineal / Surface / 3180mm / 4 Spots 30mm IP40 ▷90° ◂320° 	<b>36</b> 39.6W	<b>VA</b> 2700K / CRI 90 / 3540 lm	<b>PL</b> Opal	<b>OS</b> ON-OFF 220-240V	
		<b>WA</b> 3000K / CRI 90 / 3540 lm		<b>OR</b> ON-OFF Remote 220-240V	
<b>AW46 -</b> Lineal / Pendant / 3180mm / 4 Spots 30mm IP20 ▷90° ◂320° 	<b>48</b> 57W	<b>XA</b> 4000K / CRI 90 / 3540 lm	<b>BE</b> Bento 52	<b>DS</b> DALI 220-240V	
		<b>V9</b> 2700K / CRI 90 / 4582 lm		<b>DR</b> DALI Remote 220-240V	
<b>AW44 -</b> Lineal / Surface / 4190mm / 4 Spots 30mm IP40 ▷90° ◂320° 	<b>48</b> 52.8W	<b>W9</b> 3000K / CRI 90 / 5074 lm	<b>PL</b> Opal	<b>OR</b> ON-OFF Remote 220-240V	
		<b>X9</b> 4000K / CRI 90 / 4582 lm		<b>DS</b> DALI 220-240V	
<b>AW47 -</b> Lineal / Pendant / 4190mm / 4 Spots 30mm IP20 ▷90° ◂320° 	<b>66</b> 78.8W	<b>V9</b> 2700K / CRI 90 / 6145 lm	<b>BE</b> Bento 52	<b>DR</b> DALI Remote 220-240V	
		<b>W9</b> 3000K / CRI 90 / 6883 lm		<b>XB</b> CASAMBI 220-240V	
<b>AW47 -</b> Lineal / Pendant / 4190mm / 4 Spots 30mm IP20 ▷90° ◂320° 	<b>66</b> 78.8W	<b>X9</b> 4000K / CRI 90 / 6145 lm	<b>BE</b> Bento 52	<b>XR</b> CASAMBI Remote 220-240V	

SISTEMAS LINEALES | SISTEMAS LINEARES



# Apex Lineal Double Spot Big



Ejemplo de código / Exemplo de código: **AW55-36VAPLOS14**

Model	W	K / CRI / Real lm	Optics	Source	Finishes
 <b>AW55 -</b> Lineal / Surface / 1595mm / 2 Spots 52mm IP40 90° 120°	<b>36</b> 39.6W	<b>VA</b> 2700K / CRI 90 / 2898 lm	<b>PL</b> Opal	<b>OS</b> ON-OFF 220-240V	<b>14</b> <b>60</b>
		<b>WA</b> 3000K / CRI 90 / 2898 lm		<b>OR</b> ON-OFF Remote 220-240V	
<b>XA</b> 4000K / CRI 90 / 2898 lm	<b>DS</b> DALI 220-240V				
<b>42</b> 50.7W	<b>V9</b> 2700K / CRI 90 / 3419 lm	<b>BE</b> Bento 52	<b>DR</b> DALI Remote 220-240V		
<b>W9</b> 3000K / CRI 90 / 3665 lm	<b>XB</b> CASAMBI 220-240V				
<b>X9</b> 4000K / CRI 90 / 3419 lm	<b>XR</b> CASAMBI Remote 220-240V				
 <b>AW58 -</b> Lineal / Surface / 3180mm / 4 Spots 52mm IP40 90° 120°	<b>72</b> 79.2W	<b>VA</b> 2700K / CRI 90 / 3940 lm	<b>PL</b> Opal	<b>OS</b> ON-OFF 220-240V	
		<b>WA</b> 3000K / CRI 90 / 3940 lm		<b>OR</b> ON-OFF Remote 220-240V	
<b>XA</b> 4000K / CRI 90 / 3940 lm	<b>DS</b> DALI 220-240V				
<b>84</b> 97.6W	<b>V9</b> 2700K / CRI 90 / 6838 lm	<b>BE</b> Bento 52	<b>DR</b> DALI Remote 220-240V		
<b>W9</b> 3000K / CRI 90 / 7330 lm	<b>XB</b> CASAMBI 220-240V				
<b>X9</b> 4000K / CRI 90 / 6838 lm	<b>XR</b> CASAMBI Remote 220-240V				
 <b>AW59 -</b> Lineal / Pendant / 3180mm / 4 Spots 52mm IP20 90° 120°	<b>84</b> 92.4W	<b>VA</b> 2700K / CRI 90 / 6838 lm	<b>PL</b> Opal	<b>OS</b> ON-OFF 220-240V	
		<b>WA</b> 3000K / CRI 90 / 6838 lm		<b>OR</b> ON-OFF Remote 220-240V	
<b>XA</b> 4000K / CRI 90 / 6838 lm	<b>DS</b> DALI 220-240V				
<b>CP</b> 119.4W	<b>V9</b> 2700K / CRI 90 / 8401 lm	<b>BE</b> Bento 52	<b>DR</b> DALI Remote 220-240V		
<b>W9</b> 3000K / CRI 90 / 9139 lm	<b>XB</b> CASAMBI 220-240V				
<b>X9</b> 4000K / CRI 90 / 8401 lm	<b>XR</b> CASAMBI Remote 220-240V				
 <b>AW57 -</b> Lineal / Surface / 4190mm / 4 Spots 52mm IP40 90° 120°	<b>CP</b> 119.4W	<b>V9</b> 2700K / CRI 90 / 8401 lm	<b>BE</b> Bento 52	<b>DR</b> DALI Remote 220-240V	
		<b>W9</b> 3000K / CRI 90 / 9139 lm		<b>XB</b> CASAMBI 220-240V	
<b>X9</b> 4000K / CRI 90 / 8401 lm	<b>XR</b> CASAMBI Remote 220-240V				
 <b>AW61 -</b> Lineal / Pendant / 4190mm / 4 Spots 52mm IP20 90° 120°	<b>CP</b> 119.4W	<b>V9</b> 2700K / CRI 90 / 8401 lm	<b>BE</b> Bento 52	<b>DR</b> DALI Remote 220-240V	
		<b>W9</b> 3000K / CRI 90 / 9139 lm		<b>XB</b> CASAMBI 220-240V	
<b>X9</b> 4000K / CRI 90 / 8401 lm	<b>XR</b> CASAMBI Remote 220-240V				

# Apex Lineal Triple Spot Small



INDOOR

Ejemplo de código / Exemplo de código: **AW48-21VAPLOS14**

Model	W	K / CRI / Real lm	Optics	Source	Finishes
 <b>AW48 -</b> Lineal / Surface / 1595mm / 3 Spots 30mm IP40 90° 320°	<b>21</b> 23.1W	<b>VA</b> 2700K / CRI 90 / 2134 lm	<b>PL</b> Opal	<b>OS</b> ON-OFF 220-240V	<b>14</b> <b>60</b>
		<b>WA</b> 3000K / CRI 90 / 2134 lm		<b>OR</b> ON-OFF Remote 220-240V	
<b>XA</b> 4000K / CRI 90 / 2134 lm	<b>DS</b> DALI 220-240V				
<b>V9</b> 2700K / CRI 90 / 2655 lm	<b>BE</b> Bento 52	<b>DR</b> DALI Remote 220-240V			
<b>W9</b> 3000K / CRI 90 / 2901 lm		<b>XB</b> CASAMBI 220-240V			
<b>X9</b> 4000K / CRI 90 / 2655 lm		<b>XR</b> CASAMBI Remote 220-240V			
 <b>AW52 -</b> Lineal / Pendant / 1595mm / 3 Spots 30mm IP20 90° 320°	<b>27</b> 33.3W	<b>V9</b> 2700K / CRI 90 / 2655 lm	<b>BE</b> Bento 52	<b>DR</b> DALI Remote 220-240V	
		<b>W9</b> 3000K / CRI 90 / 2901 lm		<b>XB</b> CASAMBI 220-240V	
<b>X9</b> 4000K / CRI 90 / 2655 lm	<b>XR</b> CASAMBI Remote 220-240V				
 <b>AW49 -</b> Lineal / Surface / 3180mm / 6 Spots 30mm IP40 90° 320°	<b>42</b> 46.2W	<b>VA</b> 2700K / CRI 90 / 4268 lm	<b>PL</b> Opal	<b>OS</b> ON-OFF 220-240V	
		<b>WA</b> 3000K / CRI 90 / 4268 lm		<b>OR</b> ON-OFF Remote 220-240V	
<b>XA</b> 4000K / CRI 90 / 4268 lm	<b>DS</b> DALI 220-240V				
<b>V9</b> 2700K / CRI 90 / 5310 lm	<b>BE</b> Bento 52	<b>DR</b> DALI Remote 220-240V			
<b>W9</b> 3000K / CRI 90 / 5802 lm		<b>XB</b> CASAMBI 220-240V			
<b>X9</b> 4000K / CRI 90 / 5310 lm		<b>XR</b> CASAMBI Remote 220-240V			
 <b>AW53 -</b> Lineal / Pendant / 3180mm / 6 Spots 30mm IP20 90° 320°	<b>54</b> 63.5W	<b>V9</b> 2700K / CRI 90 / 5310 lm	<b>BE</b> Bento 52	<b>DR</b> DALI Remote 220-240V	
		<b>W9</b> 3000K / CRI 90 / 5802 lm		<b>XB</b> CASAMBI 220-240V	
<b>X9</b> 4000K / CRI 90 / 5310 lm	<b>XR</b> CASAMBI Remote 220-240V				
 <b>AW51 -</b> Lineal / Surface / 4190mm / 6 Spots 30mm IP40 90° 320°	<b>54</b> 59.4W	<b>VA</b> 2700K / CRI 90 / 5310 lm	<b>PL</b> Opal	<b>OS</b> ON-OFF 220-240V	
		<b>WA</b> 3000K / CRI 90 / 5310 lm		<b>OR</b> ON-OFF Remote 220-240V	
<b>XA</b> 4000K / CRI 90 / 5310 lm	<b>DS</b> DALI 220-240V				
<b>V9</b> 2700K / CRI 90 / 6873 lm	<b>BE</b> Bento 52	<b>DR</b> DALI Remote 220-240V			
<b>W9</b> 3000K / CRI 90 / 7611 lm		<b>XB</b> CASAMBI 220-240V			
<b>X9</b> 4000K / CRI 90 / 6873 lm		<b>XR</b> CASAMBI Remote 220-240V			
 <b>AW54 -</b> Lineal / Pendant / 4190mm / 6 Spots 30mm IP20 90° 320°	<b>72</b> 85.3W	<b>V9</b> 2700K / CRI 90 / 6873 lm	<b>BE</b> Bento 52	<b>DR</b> DALI Remote 220-240V	
		<b>W9</b> 3000K / CRI 90 / 7611 lm		<b>XB</b> CASAMBI 220-240V	
<b>X9</b> 4000K / CRI 90 / 6873 lm	<b>XR</b> CASAMBI Remote 220-240V				

SISTEMAS LINEALES | SISTEMAS LINEARES

BODY MAT
AL



50000h
L80 B20









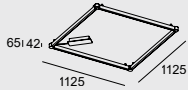

2:3
MacAdam

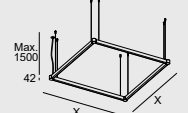
## Apex Square

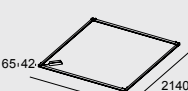
UGR
<10

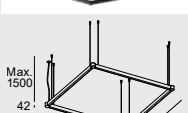

Ejemplo de código / Exemplo de código: **AW22-48VAPLOS14**

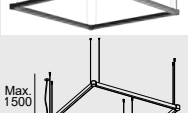
Model	W	K / CRI / Real lm	Optics	Source	Finishes
 <b>AW22 -</b> Square / Surface / 1000mm IP40 	<b>48</b> 52.8W	<b>VA</b> 2700K / CRI 90 / 4168 lm	<b>PL</b> Opal	<b>OS</b> ON-OFF 220-240V	<b>14</b> <b>60</b>
		<b>WA</b> 3000K / CRI 90 / 4168 lm		<b>OR</b> ON-OFF Remote 220-240V	
		<b>XA</b> 4000K / CRI 90 / 4168 lm		<b>DS</b> DALI 220-240V	
 <b>AW25 -</b> Square / Pendant / 1000mm IP20 	<b>72</b> 86.8W	<b>V9</b> 2700K / CRI 90 / 6252 lm	<b>BE</b> Bento 52	<b>DR</b> DALI Remote 220-240V	
		<b>W9</b> 3000K / CRI 90 / 7236 lm		<b>XB</b> CASAMBI 220-240V	
		<b>X9</b> 4000K / CRI 90 / 6252 lm		<b>XR</b> CASAMBI Remote 220-240V	
 <b>AW23 -</b> Square / Surface / 2000mm IP40 	<b>96</b> 105.6W	<b>VA</b> 2700K / CRI 90 / 8336 lm	<b>PL</b> Opal	<b>OS</b> ON-OFF 220-240V	
		<b>WA</b> 3000K / CRI 90 / 8336 lm		<b>OR</b> ON-OFF Remote 220-240V	
		<b>XA</b> 4000K / CRI 90 / 8336 lm		<b>DS</b> DALI 220-240V	
 <b>AW26 -</b> Square / Pendant / 2000mm IP20 	<b>C4</b> 165.9W	<b>V9</b> 2700K / CRI 90 / 12504 lm	<b>BE</b> Bento 52	<b>DR</b> DALI Remote 220-240V	
		<b>W9</b> 3000K / CRI 90 / 14472 lm		<b>XB</b> CASAMBI 220-240V	
		<b>X9</b> 4000K / CRI 90 / 12504 lm		<b>XR</b> CASAMBI Remote 220-240V	
 <b>AW24 -</b> Square / Surface / 3000mm IP40 	<b>C4</b> 158.4W	<b>VA</b> 2700K / CRI 90 / 12504 lm	<b>PL</b> Opal	<b>OS</b> ON-OFF 220-240V	
		<b>WA</b> 3000K / CRI 90 / 12504 lm		<b>OR</b> ON-OFF Remote 220-240V	
		<b>XA</b> 4000K / CRI 90 / 12504 lm		<b>DS</b> DALI 220-240V	
 <b>AW27 -</b> Square / Pendant / 3000mm IP20 	<b>D1</b> 248.4W	<b>V9</b> 2700K / CRI 90 / 18756 lm	<b>BE</b> Bento 52	<b>DR</b> DALI Remote 220-240V	
		<b>W9</b> 3000K / CRI 90 / 21708 lm		<b>XB</b> CASAMBI 220-240V	
		<b>X9</b> 4000K / CRI 90 / 18756 lm		<b>XR</b> CASAMBI Remote 220-240V	

## Apex Rectangular

Ejemplo de código / Exemplo de código: **AW28-72VAPLOS14**

Model	W	K / CRI / Real lm	Optics	Source	Finishes
 	<b>72</b> 79.2W	<b>VA</b> 2700K / CRI 90 / 6252 lm	<b>PL</b> Opal	<b>OS</b> ON-OFF 220-240V	<b>14</b> <b>60</b>
		<b>WA</b> 3000K / CRI 90 / 6252 lm		<b>OR</b> ON-OFF Remote 220-240V	
		<b>XA</b> 4000K / CRI 90 / 6252 lm		<b>DS</b> DALI 220-240V	
	<b>CP</b> 126.4W	<b>V9</b> 2700K / CRI 90 / 9378 lm	<b>BE</b> Bento 52	<b>DR</b> DALI Remote 220-240V	
		<b>W9</b> 3000K / CRI 90 / 10854 lm		<b>XB</b> CASAMBI 220-240V	
		<b>X9</b> 4000K / CRI 90 / 9378 lm		<b>XR</b> CASAMBI Remote 220-240V	

 	<b>96</b> 105.6W	<b>VA</b> 2700K / CRI 90 / 8336 lm	<b>PL</b> Opal	<b>OS</b> ON-OFF 220-240V	
		<b>WA</b> 3000K / CRI 90 / 8336 lm		<b>OR</b> ON-OFF Remote 220-240V	
		<b>XA</b> 4000K / CRI 90 / 8336 lm		<b>DS</b> DALI 220-240V	
	<b>C4</b> 168.3W	<b>V9</b> 2700K / CRI 90 / 12504 lm	<b>BE</b> Bento 52	<b>DR</b> DALI Remote 220-240V	
		<b>W9</b> 3000K / CRI 90 / 14472 lm		<b>XB</b> CASAMBI 220-240V	
		<b>X9</b> 4000K / CRI 90 / 12504 lm		<b>XR</b> CASAMBI Remote 220-240V	

 	<b>96</b> 105.6W	<b>VA</b> 2700K / CRI 90 / 8336 lm	<b>PL</b> Opal	<b>OS</b> ON-OFF 220-240V	
		<b>WA</b> 3000K / CRI 90 / 8336 lm		<b>OR</b> ON-OFF Remote 220-240V	
		<b>XA</b> 4000K / CRI 90 / 8336 lm		<b>DS</b> DALI 220-240V	
	<b>C4</b> 168.3W	<b>V9</b> 2700K / CRI 90 / 12504 lm	<b>BE</b> Bento 52	<b>DR</b> DALI Remote 220-240V	
		<b>W9</b> 3000K / CRI 90 / 14472 lm		<b>XB</b> CASAMBI 220-240V	
		<b>X9</b> 4000K / CRI 90 / 12504 lm		<b>XR</b> CASAMBI Remote 220-240V	

 	<b>96</b> 105.6W	<b>VA</b> 2700K / CRI 90 / 8336 lm	<b>PL</b> Opal	<b>OS</b> ON-OFF 220-240V	
		<b>WA</b> 3000K / CRI 90 / 8336 lm		<b>OR</b> ON-OFF Remote 220-240V	
		<b>XA</b> 4000K / CRI 90 / 8336 lm		<b>DS</b> DALI 220-240V	
	<b>C4</b> 168.3W	<b>V9</b> 2700K / CRI 90 / 12504 lm	<b>BE</b> Bento 52	<b>DR</b> DALI Remote 220-240V	
		<b>W9</b> 3000K / CRI 90 / 14472 lm		<b>XB</b> CASAMBI 220-240V	
		<b>X9</b> 4000K / CRI 90 / 12504 lm		<b>XR</b> CASAMBI Remote 220-240V	

BODY MAT
AL



50000h
L80 B20





2:3
MacAdam

## Apex Circular & Oval

UGR
<10

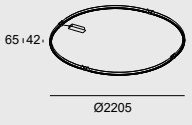

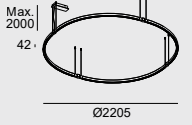
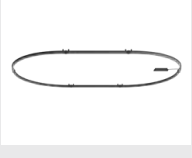
Ejemplo de código / Exemplo de código: **AW17-48VAPLOS14**

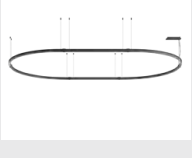
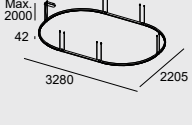
Model	W	K / CRI / Real lm	Optics	Source	Finishes
 <p><b>AW17 -</b> Circular / Surface IP40</p>  <p>65 x 42 Ø2205</p>	48 68W	<b>VA</b> 2700K / CRI 90 / 6545 lm <b>WA</b> 3000K / CRI 90 / 6545 lm <b>XA</b> 4000K / CRI 90 / 6545 lm	<b>PL</b> Opal	<b>OS</b> ON-OFF 220-240V <b>OR</b> ON-OFF Remote 220-240V <b>DS</b> DALI 220-240V <b>DR</b> DALI Remote 220-240V <b>XB</b> CASAMBI 220-240V <b>XR</b> CASAMBI Remote 220-240V	<b>14</b> <b>60</b>
		 <p><b>AW18 -</b> Circular / Pendant IP40</p>  <p>Max. 2000 42 Ø2205</p>			
 <p><b>AW19 -</b> Oval / Surface IP40</p>  <p>65 x 42 3280 2205</p>	72 92W	<b>VA</b> 2700K / CRI 90 / 8629 lm <b>WA</b> 3000K / CRI 90 / 8629 lm <b>XA</b> 4000K / CRI 90 / 8629 lm	<b>PL</b> Opal	<b>OS</b> ON-OFF 220-240V <b>OR</b> ON-OFF Remote 220-240V <b>DS</b> DALI 220-240V <b>DR</b> DALI Remote 220-240V <b>XB</b> CASAMBI 220-240V <b>XR</b> CASAMBI Remote 220-240V	
		 <p><b>AW21 -</b> Oval / Pendant IP40</p>  <p>Max. 2000 42 3280 2205</p>			

## Apex H

Ejemplo de código / Exemplo de código: **AW35-60VAPLOS14**

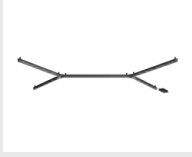
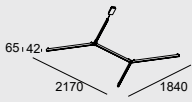
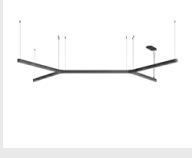
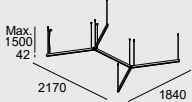
Model	W	K / CRI / Real lm	Optics	Source	Finishes
 <p><b>AW35 -</b> "H" / Surface IP40</p> 	<b>60</b> 66W	<b>VA</b> 2700K / CRI 90 / 5210 lm	<b>PL</b> Opal	<b>OS</b> ON-OFF 220-240V	<b>14</b> <b>60</b>
		<b>WA</b> 3000K / CRI 90 / 5210 lm		<b>OR</b> ON-OFF Remote 220-240V	
		<b>XA</b> 4000K / CRI 90 / 5210 lm		<b>DS</b> DALI 220-240V	
	<b>90</b> 124.4W	<b>V9</b> 2700K / CRI 90 / 7815 lm	<b>BE</b> Bento 52	<b>DR</b> DALI Remote 220-240V	
		<b>W9</b> 3000K / CRI 90 / 9045 lm		<b>XB</b> CASAMBI 220-240V	
		<b>X9</b> 4000K / CRI 90 / 7815 lm		<b>XR</b> CASAMBI Remote 220-240V	
 <p><b>AW36 -</b> "H" / Pendant IP20</p> 					

# Apex M

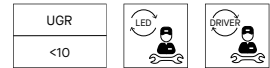

Ejemplo de código / Exemplo de código: **AW39-48VAPLOS14**

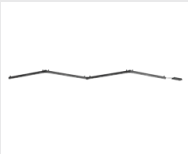
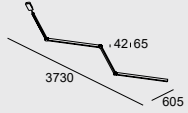
Model	W	K / CRI / Real lm	Optics	Source	Finishes
 <p><b>AW39 -</b> "M" / Surface IP40</p> 	<b>48</b> 52.8W	<b>VA</b> 2700K / CRI 90 / 4168 lm	<b>PL</b> Opal	<b>OS</b> ON-OFF 220-240V	<b>14</b> <b>60</b>
		<b>WA</b> 3000K / CRI 90 / 4168 lm		<b>OR</b> ON-OFF Remote 220-240V	
		<b>XA</b> 4000K / CRI 90 / 4168 lm		<b>DS</b> DALI 220-240V	
	<b>72</b> 86.8W	<b>V9</b> 2700K / CRI 90 / 6252 lm	<b>BE</b> Bento 52	<b>DR</b> DALI Remote 220-240V	
		<b>W9</b> 3000K / CRI 90 / 7236 lm		<b>XB</b> CASAMBI 220-240V	
		<b>X9</b> 4000K / CRI 90 / 6252 lm		<b>XR</b> CASAMBI Remote 220-240V	

# Apex Y

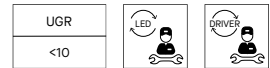



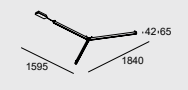

Ejemplo de código / Exemplo de código: **AW33-36VAPLOS14**

Model	W	K / CRI / Real lm	Optics	Source	Finishes
 <p><b>AW33 -</b> "Y" / Surface IP40</p> 	<b>36</b> 39.6W	<b>VA</b> 2700K / CRI 90 / 3126 lm	<b>PL</b> Opal	<b>OS</b> ON-OFF 220-240V	<b>14</b> <b>60</b>
		<b>WA</b> 3000K / CRI 90 / 3126 lm		<b>OR</b> ON-OFF Remote 220-240V	
		<b>XA</b> 4000K / CRI 90 / 3126 lm		<b>DS</b> DALI 220-240V	
	<b>54</b> 65.1W	<b>V9</b> 2700K / CRI 90 / 4689 lm	<b>BE</b> Bento 52	<b>DR</b> DALI Remote 220-240V	
		<b>W9</b> 3000K / CRI 90 / 5427 lm		<b>XB</b> CASAMBI 220-240V	
		<b>X9</b> 4000K / CRI 90 / 4689 lm		<b>XR</b> CASAMBI Remote 220-240V	

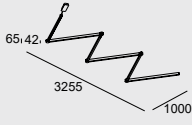
 <p><b>AW34 -</b> "Y" / Pendant IP20</p> 					
-------------------------------------------------------------------------------------------------------------------------------------------------------------------------------------------------------------------------	--	--	--	--	--

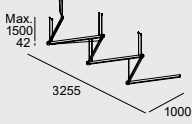
Ejemplo de código / Exemplo de código: **AW37-72VAPLOS14**

Model	W	K / CRI / Real lm	Optics	Source	Finishes
 <p><b>AW37 -</b> "WW" / Surface IP40</p> 	<b>72</b> 79.2W	<b>VA</b> 2700K / CRI 90 / 6252 lm	<b>PL</b> Opal	<b>OS</b>  <b>OR</b>  <b>DS</b>	<b>14</b>  <b>60</b> 
		<b>WA</b> 3000K / CRI 90 / 6252 lm <b>XA</b> 4000K / CRI 90 / 6252 lm			
 <p><b>AW38 -</b> "WW" / Pendant IP20</p> 	<b>CP</b> 130.2W	<b>V9</b> 2700K / CRI 90 / 9378 lm	<b>BE</b> Bento 52	<b>DR</b>	
		<b>W9</b> 3000K / CRI 90 / 10854 lm		<b>XB</b> 	
		<b>X9</b> 4000K / CRI 90 / 9378 lm		<b>XR</b> 	



# Infinite Pro



+ Infinite Pro



## Solución para espacios de trabajo que cuidan el bienestar de las personas Solução para espaços de trabalho que cuidam do bem-estar das pessoas

Infinite Pro es la solución perfecta para iluminar espacios que requieren un alto confort, ofreciendo una iluminación concebida para mejorar el bienestar de las personas y las empresas, sobre todo en oficinas o en zonas de trabajo donde la calidad de la luz es fundamental.

Infinite Pro é a solução perfeita para a iluminação de espaços que requerem um elevado nível de conforto, oferecendo uma iluminação concebida para melhorar o bem-estar de pessoas e empresas, sobretudo em escritórios ou zonas de trabalho onde a qualidade da luz é fundamental.







**Proyecto arts London.** Gracias a la funcionalidad Smart Bluetooth Casambi las luminarias pueden gestionarse de forma autónoma.  
**Projeto arts London.** Graças à funcionalidade Smart Bluetooth Casambi, as luminárias podem ser geridas de forma autónoma.



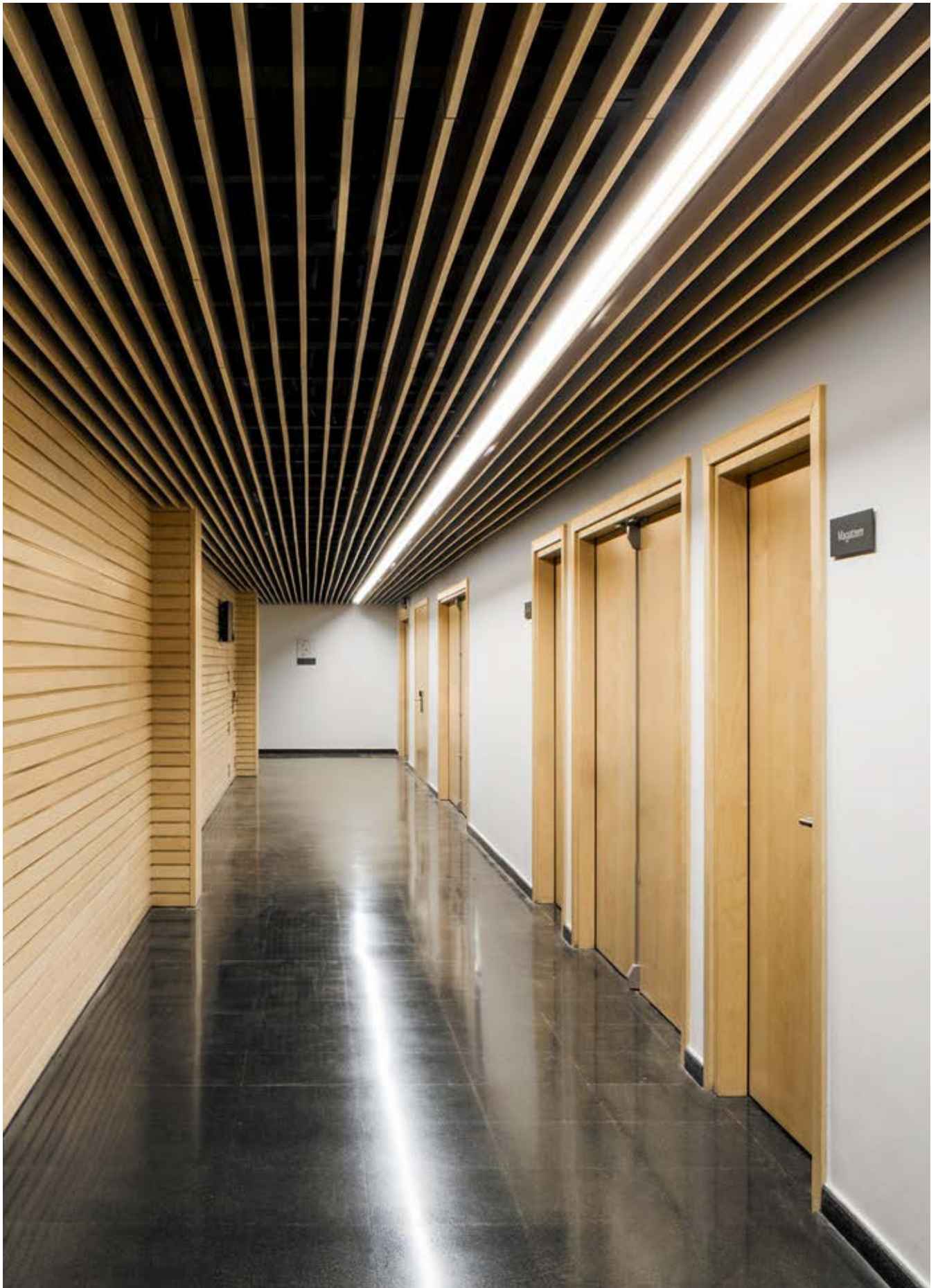

## Easy Click

Posibilidad de fácil concatenación

para crear luminarias infinitas

Possibilidade de fácil concatenação

para criar luminárias infinitas





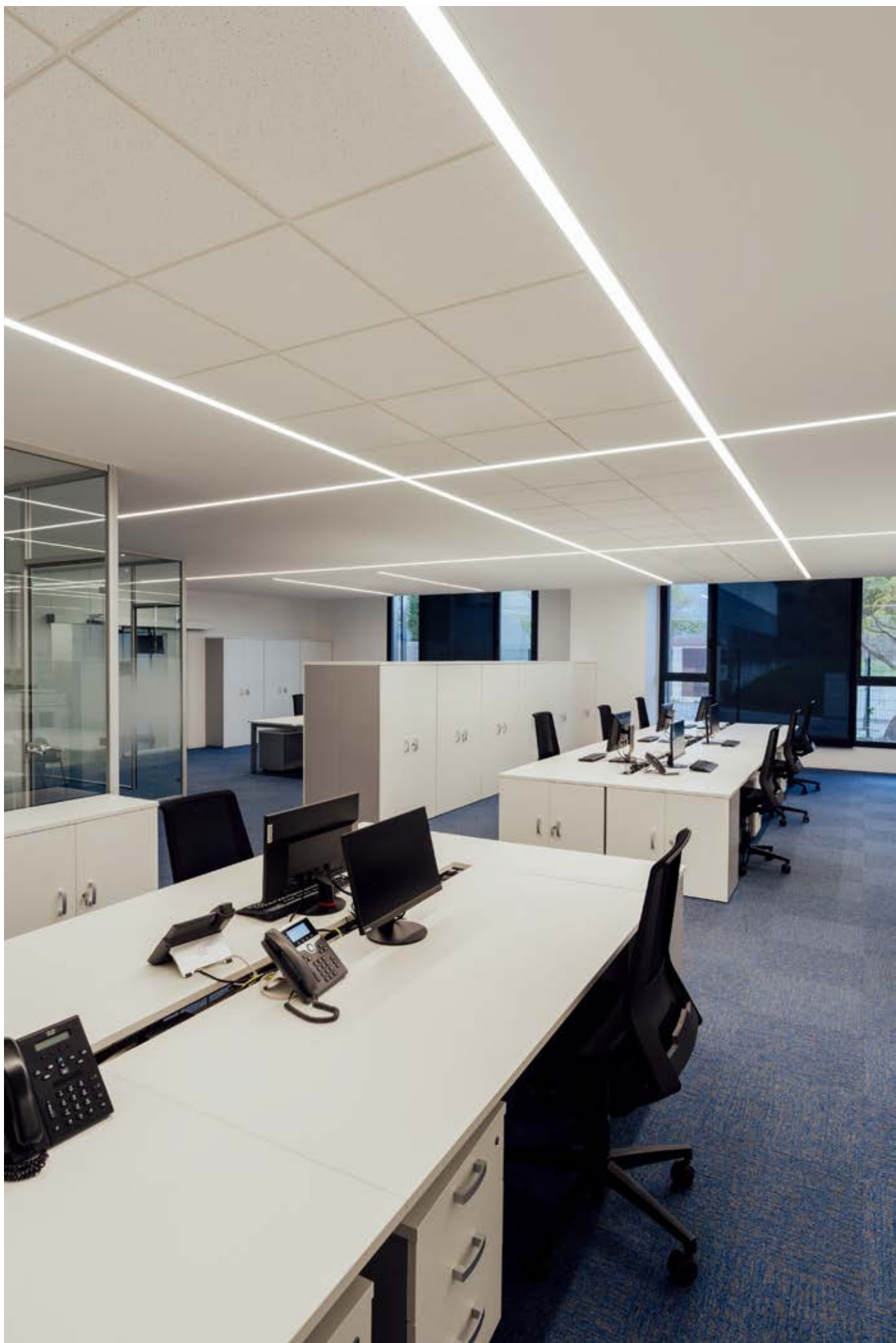

Proyecto especial con producto personalizado para las oficinas Manusa de Barcelona.  
Projeto especial com produto personalizado para os escritórios Manusa de Barcelona.

Diferentes  
combinaciones de  
estructura y módulo  
Diferentes  
combinações de  
estrutura e módulo



## Lentes



**Opal**  
UGR < 22

Efecto homogéneo y confortable.  
Efeito homogéneo e confortável.



**Microprisma**  
UGR < 22

Solución micrograbada que aporta un plus de eficiencia.  
Solução micro-gravada para uma eficiência extra.



## Haloprisma

UGR < 19

Eficiencia de 138 lm/W con un alto paquete lumínico.  
Eficiência de 138 lm/W com um pacote de lúmen elevado.



## Hexacell

UGR < 10

Alto confort visual con efecto dark light.  
Alto conforto visual com efeito de luz escura.



## Opticell

UGR < 16

Equilibrio perfecto entre ángulo de salida (>74°), UGR <16 y una eficiencia de 156 lm/W.  
Perfeito equilíbrio entre o ângulo de saída (>74°), UGR <16 e uma eficiência de 156 lm/W.



## 90°

Óptimo control, bajo deslumbramiento y máxima precisión.  
Controlo óptimo, baixo brilho e máxima precisão.



## Wall Washer

Efecto bañador de pared de alta homogeneidad.  
Efeito de wallwash de alta homogeneidade.



## Lente Eliptic

Diseñada para espacios que requieren distribución central sin perturbaciones laterales.  
Concebido para espaços que requerem distribuição central sem distúrbios laterais.



## Batwing

Ideales para distribuciones lineales, como las que se usan en retail.  
Ideal para distribuições lineares, tais como as utilizadas no comércio a retalho.



## Track

Integración de un carril trifásico para la instalación de proyectores.  
Integração de uma pista trifásica para instalação de holofotes.



Opciones de instalación  
Opções de instalação

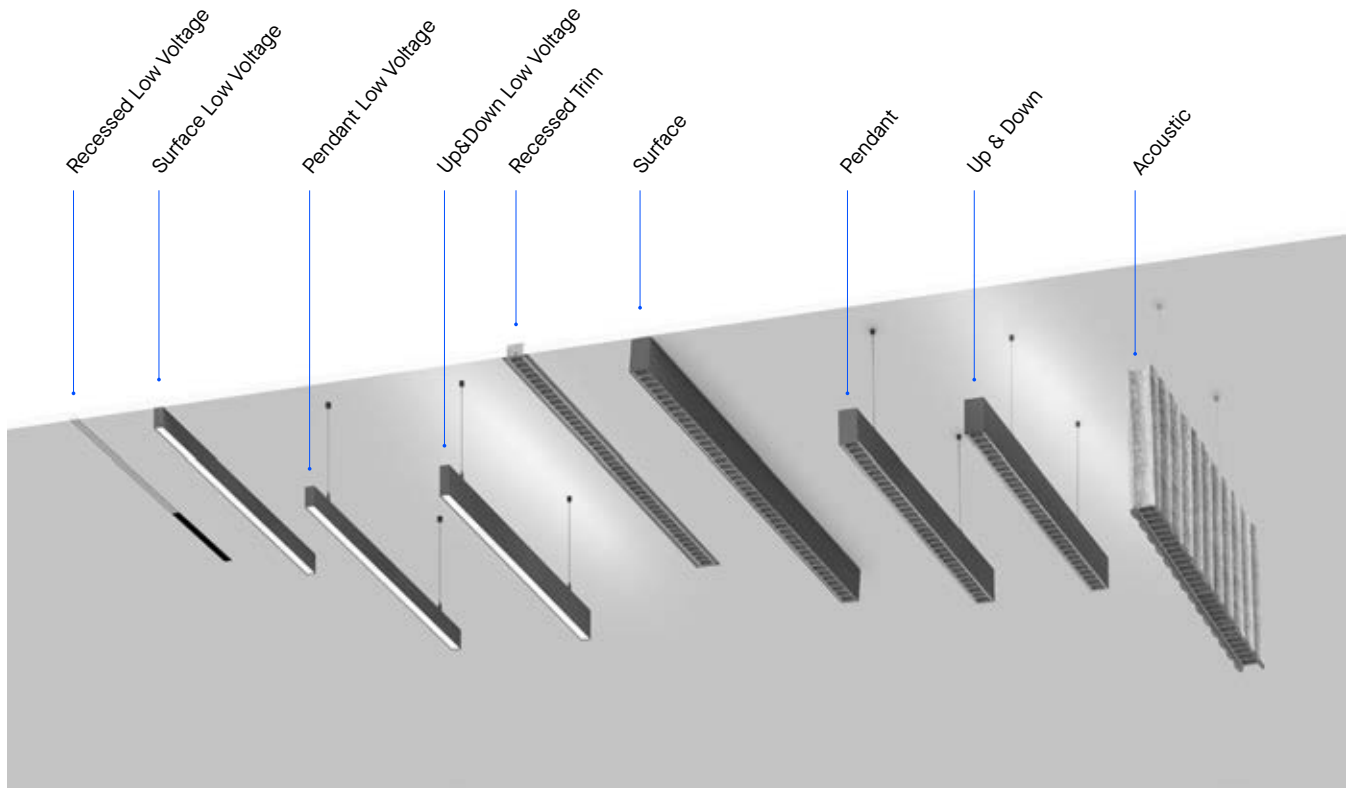

## Funcionalidad Smart Funcionalidade Smart

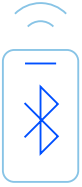

Mediante la tecnología D4i se permite la monitorización de la ocupación, permitiendo maximizar la eficiencia de los espacios, adaptarlos y redistribuirlos según las necesidades de cada situación y tomar decisiones en función de las necesidades de las personas.

A tecnologia D4i permite a monitorização da ocupação, maximizando a eficiência dos espaços, adaptando-os e redistribuindo-os de acordo com as necessidades de cada situação e tomando decisões baseadas nas necessidades das pessoas.



Intensidad 80%. Escena con ocupación.  
Intensidade 80%. Cena com ocupação.



Intensidad 25%. Escena sin ocupación.  
Intensidade 25%. Cena sem ocupação.

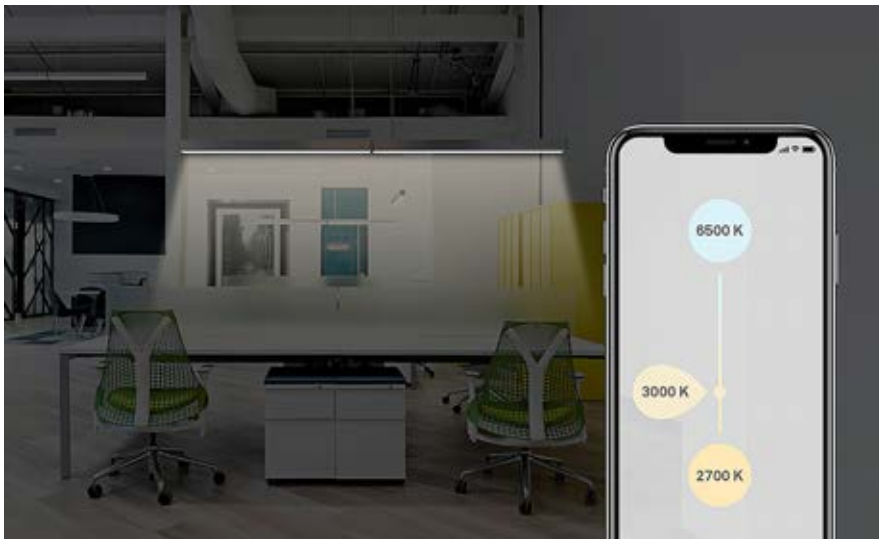

Opción Tunable White  
que regula la temperatura  
de color simulando  
la luz natural

Opção Tunable White que  
regula a temperatura da  
cor através da simulação  
da luz natural

Infinite Pro Acoustic está fabricada con materiais fonoabsorbentes que amortiguan el ruido ambiental  
Infinite Pro Acoustic está fabricada con materiales fonoabsorbentes que amortiguan el ruido ambiental.

Versiónes disponibles sin luz y con ópticas opal, microprisma, haloprisma, hexacell y opticell.

Versões disponíveis sem luz e com óticas opal, microprismatic, haloprisma, hexacell y opticell.

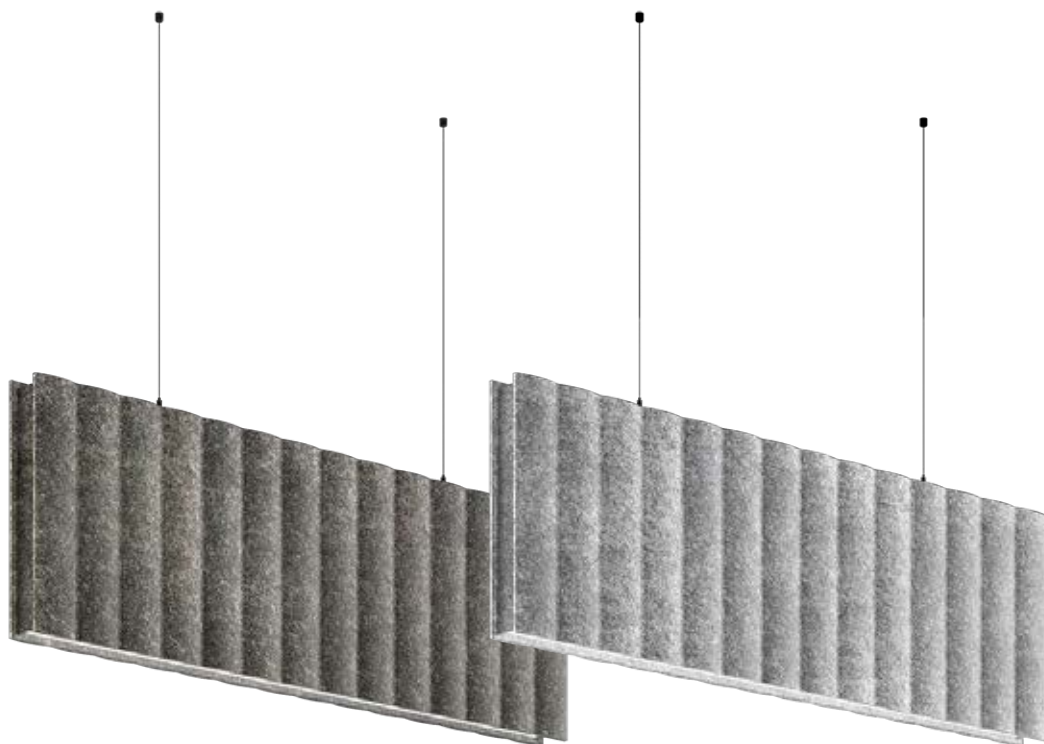







Sensor incorporado para regular la luz en función de luminosidad proporcionada por la luz natural y la presencia de personas.  
 Sensor incorporado para regular a luz em função da luminosidade proporcionada pela luz natural e a presença de pessoas.



Opciones de configuración infinitas de forma fácil y rápida gracias nuestro configurador online.

Opções de configuração infinitas de uma forma rápida e fácil, graças ao nosso configurador online.



1 Selección de instalación  
Seleção da instalação



2 Selección de difusor  
Seleção de difusor



3 Selección de LEDS  
Seleção de LEDS



4 Selección de propiedades  
Seleção de propriedades



5 Descarga de documentación  
Descarregar de documentação

6 Descarga de documentación  
Descarregar documentação

# Infinite Pro

## Infinite Pro Opticell

IP
40

BODY MAT
AL

UGR
<19

DIF MAT
PC



50000h
L80 B20

3
MacAdam





Ejemplo de código / Exemplo de código: **AK11-12W8CLOS14**

Model	W	K / CRI / Real lm	Optics	Source	Finishes	
<b>854 mm</b>  <b>AK11 - Superficie Superficie</b>  <b>AK12 - Suspendida Suspensa</b>  <b>AK13 - Empotrada Encastrada</b>	<b>12</b> 11.8W	<b>W8</b> 3000K / CRI 80 / 1751 lm	<b>CL</b> Opticell 	<b>OS</b> ON-OFF 220-240V <b>DS</b> DALI 220-240V	<b>14</b> <b>N3</b> <b>60</b> <b>GA</b> <b>GB</b>	
		<b>W9</b> 3000K / CRI 90 / 1576 lm				
		<b>X8</b> 4000K / CRI 80 / 1829 lm				
		<b>X9</b> 4000K / CRI 90 / 1576 lm				
	<b>24</b> 24.4W	<b>W8</b> 3000K / CRI 80 / 3381 lm				
		<b>W9</b> 3000K / CRI 90 / 3043 lm				
		<b>X8</b> 4000K / CRI 80 / 3530 lm				
		<b>X9</b> 4000K / CRI 90 / 3043 lm				
		<b>WR</b> DALI D4i 220-240V <b>XB</b> CASAMBI 220-240V				
<b>18</b> 16.8W	<b>U8</b> TW 2700K-6500K / CRI 80 / 2630 lm	<b>TW</b> DALI DT8 220-240V <b>XC</b> CASAMBI + TW 220-240V				
<b>1136 mm</b>  <b>AK14 - Superficie Superficie</b>  <b>AK15 - Suspendida Suspensa</b>  <b>AK16 - Empotrada Encastrada</b>  <b>AK23 - Suspendida / Acústica Suspensa / Acústica</b>	<b>16</b> 15.8W	<b>W8</b> 3000K / CRI 80 / 2280 lm	<b>CL</b> Opticell 	<b>OS</b> ON-OFF 220-240V <b>DS</b> DALI 220-240V		
		<b>W9</b> 3000K / CRI 90 / 2052 lm				
		<b>X8</b> 4000K / CRI 80 / 2381 lm				
		<b>X9</b> 4000K / CRI 90 / 2052 lm				
	<b>32</b> 32.6W	<b>W8</b> 3000K / CRI 80 / 4402 lm				
		<b>W9</b> 3000K / CRI 90 / 3962 lm				
		<b>X8</b> 4000K / CRI 80 / 4596 lm				
	<b>24</b> 22.4W	<b>U8</b> TW 2700K-6500K / CRI 80 / 3424 lm				<b>WR</b> DALI D4i 220-240V <b>XB</b> CASAMBI 220-240V <b>TW</b> DALI DT8 220-240V <b>XA</b> DALI D4i + TW 220-240V <b>XC</b> CASAMBI + TW 220-240V
<b>1700 mm</b>  <b>AK18 - Superficie Superficie</b>  <b>AK19 - Empotrada Encastrada</b>  <b>AK21 - Suspendida Suspensa</b>	<b>24</b> 23.7W	<b>W8</b> 3000K / CRI 80 / 3502 lm	<b>CL</b> Opticell 	<b>OS</b> ON-OFF 220-240V <b>DS</b> DALI 220-240V		
		<b>W9</b> 3000K / CRI 90 / 3152 lm				
		<b>X8</b> 4000K / CRI 80 / 3657 lm				
		<b>X9</b> 4000K / CRI 90 / 3152 lm				
	<b>48</b> 48.9W	<b>W8</b> 3000K / CRI 80 / 6762 lm				
		<b>W9</b> 3000K / CRI 90 / 6086 lm				
		<b>X8</b> 4000K / CRI 80 / 7060 lm				
	<b>36</b> 33.7W	<b>U8</b> TW 2700K-6500K / CRI 80 / 5259 lm				<b>X9</b> 4000K / CRI 90 / 6086 lm <b>TW</b> DALI DT8 220-240V <b>XC</b> CASAMBI + TW 220-240V













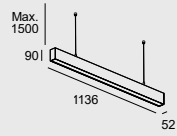









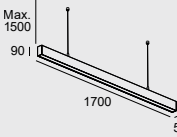

# Infinite Pro

## Infinite Pro Up&Down Opticell





IP	BODY MAT	DIF MAT		3		
40	AL	PC		MacAdam		

Ejemplo de código / Exemplo de código: **AK24-16WBCLOS14**

INDOOR



Model	W	K / CRI / Real lm		Optics	Source	Finishes		
		↑UP	↓DOWN					
<b>AK24 -</b> Suspendida / Up&Down Suspensa / Up&Down   14 60 N3	1136 mm	<b>16</b> 26.1W↑ 14.4W↓	<b>WB</b> 3000K / CRI 80 / 6084 lm	3000K / CRI 90 / 6084 lm	<b>CL</b> Opticell 	<b>OS</b>  ON-OFF 220-240V	<b>14</b>  <b>N3</b>  <b>60</b> 	
			<b>XB</b> 4000K / CRI 80 / 6342 lm	4000K / CRI 90 / 6342 lm				<b>DS</b>  DALI 220-240V
			<b>QB</b> 3000K / CRI 80 / 6084 lm	4000K / CRI 90 / 6084 lm				
			<b>RB</b> 4000K / CRI 80 / 6342 lm	3000K / CRI 90 / 6342 lm				
		<b>32</b> 26.1W↑ 29.3W↓	<b>WB</b> 3000K / CRI 80 / 7994 lm	3000K / CRI 90 / 7994 lm	<b>OS</b>  ON-OFF 220-240V			
			<b>XB</b> 4000K / CRI 80 / 8252 lm	4000K / CRI 90 / 8252 lm		<b>OU</b>  ON-OFF 100-277V		
			<b>QB</b> 3000K / CRI 80 / 7994 lm	4000K / CRI 90 / 7994 lm		<b>DS</b>  DALI 220-240V		
			<b>RB</b> 4000K / CRI 80 / 8252 lm	3000K / CRI 90 / 8252 lm		<b>WR</b>  DALI D4i 220-240V		
		<b>24</b> 25.3W↑ 21.3W↓	<b>U8</b> TW 2700K-6500K / CRI 80 / 6510 lm	TW 2700K-6500K / CRI 80 / 6510 lm	<b>TW</b>  DALI DT8 220-240V			
<b>AK25 -</b> Suspendida / Up&Down Suspensa / Up&Down   14 60 N3	1700 mm	<b>24</b> 41W↑ 21.3W↓	<b>WB</b> 3000K / CRI 80 / 9488 lm	3000K / CRI 90 / 9488 lm	<b>CL</b> Opticell 	<b>OS</b>  ON-OFF 220-240V		
			<b>XB</b> 4000K / CRI 80 / 9893 lm	4000K / CRI 90 / 9893 lm			<b>DS</b>  DALI 220-240V	
			<b>QB</b> 3000K / CRI 80 / 9488 lm	4000K / CRI 90 / 9488 lm				
			<b>RB</b> 4000K / CRI 80 / 9893 lm	3000K / CRI 90 / 9893 lm				
		<b>48</b> 41W↑ 44W↓	<b>WB</b> 3000K / CRI 80 / 12422 lm	3000K / CRI 90 / 12422 lm	<b>OS</b>  ON-OFF 220-240V			
			<b>XB</b> 4000K / CRI 80 / 12827 lm	4000K / CRI 90 / 12827 lm		<b>DS</b>  DALI 220-240V		
			<b>QB</b> 3000K / CRI 80 / 12422 lm	4000K / CRI 90 / 12422 lm		<b>XB</b>  CASAMBI 220-240V		
			<b>RB</b> 4000K / CRI 80 / 12827 lm	3000K / CRI 90 / 12827 lm				
		<b>36</b> 42.2W↑ 32W↓	<b>U8</b> TW 2700K-6500K / CRI 80 / 10392 lm	TW 2700K-6500K / CRI 80 / 10392 lm	<b>TW</b>  DALI DT8 220-240V			
					<b>XC</b>  DALI DT8 220-240V			

SISTEMAS LINEALES | SISTEMAS LINEALES

Infinite Pro Opticell 854mm Surface	Infinite Pro Opticell 1700mm Suspended	Infinite Pro Opticell 854mm Suspended	Infinite Pro Opticell 854mm Recessed
			

### Accesorios de fijación requeridos

#### Acessórios de fixação requeridos

	Florón suspendido con toma de corriente ON-OFF Florão suspenso com tomada de corrente ON-OFF	14 ○	-	<b>71-7520-14-00</b>	<b>71-7520-14-00</b>	-
		60 ●	-	-	-	-
		N3 ○	-	-	-	-
	Florón suspendido con toma de corriente DALI Florão suspenso com tomada de corrente DALI	14 ○	-	<b>71-7521-14-00</b>	<b>71-7521-14-00</b>	-
		60 ●	-	-	-	-



### Accesorios de fijación

#### Acessórios de fixação

	Accesorio para instalación en pared Acessório para instalação na parede	14 ○	<b>71-7518-14-00</b>	-	-	-
		60 ●	-	-	-	-
		N3 ○	<b>71-7518-N3-00</b>	-	-	-

### Accesorios de unión

#### Acessórios de união

	Unión 90° ON-OFF União 90° ON-OFF	14 ○	<b>71-8113-14-00</b>	<b>71-8113-14-00</b>	<b>71-8113-14-00</b>	<b>71-8112-14-00</b>
		N3 ○	<b>71-8113-N3-00</b>	-	-	-
	Unión 90° DALI União 90° DALI		<b>71-8113-14-DA</b>	<b>71-8113-14-DA</b>	<b>71-8113-14-DA</b>	<b>71-8112-14-DA</b>
	Kit unión "I" DALI Kit união "I" DALI		<b>71-A955-00-DA</b>	<b>71-A955-00-DA</b>	<b>71-A955-00-DA</b>	<b>71-A955-00-DA</b>
	Kit unión "I" ON-OFF Kit união "I" ON-OFF		<b>71-A955-00-00</b>	<b>71-A955-00-00</b>	<b>71-A955-00-00</b>	<b>71-A955-00-00</b>

### Accesorios de conexión

#### Acessórios de conexão

	Kit unión DALI Kit união DALI		-	<b>71-8246-00-DA</b>	-	<b>71-8246-00-DA</b>

Infinite Pro  
Opticell  
1136mm  
Surface



Infinite Pro  
Opticell  
1136mm  
Suspended



Infinite Pro  
Opticell  
1136mm  
Recessed



Infinite Pro  
Opticell  
1136mm  
Suspended Acoustic



### Accesorios de fijación requeridos Acessórios de fixação requeridos

	Florón suspendido con toma de corriente ON-OFF Florão suspenso com tomada de corrente ON-OFF	14 ○	-	<b>71-7520-14-00</b>	-	-
		60 ●	-	-	-	-
		N3 ○	-	-	-	-
	Florón suspendido con toma de corriente DALI Florão suspenso com tomada de corrente DALI	14 ○	-	-	-	-
		60 ●	-	-	-	-

### Accesorios de fijación Acessórios de fixação





	Accesorio para instalación en pared Acessório para instalação na parede	14 ○	<b>71-7518-14-00</b>	-	-	-
		60 ●	-	-	-	-
		N3 ○	-	-	-	-

### Accesorios de unión Acessórios de união

	Unión 90° ON-OFF União 90° ON-OFF	14 ○	<b>71-8113-14-00</b>	<b>71-8113-14-00</b>	<b>71-8112-14-00</b>	-
		N3 ○	-	-	-	-
	Unión 90° DALI União 90° DALI		<b>71-8113-14-DA</b>	-	<b>71-8112-14-DA</b>	-
	Kit unión "I" DALI Kit união "I" DALI		<b>71-A955-00-DA</b>	<b>71-A955-00-DA</b>	<b>71-A955-00-DA</b>	-
	Kit unión "I" ON-OFF Kit união "I" ON-OFF		<b>71-A955-00-00</b>	<b>71-A955-00-00</b>	<b>71-A955-00-00</b>	-

### Accesorios de conexión Acessórios de conexão

	Kit unión DALI Kit união DALI		-	-	<b>71-8246-00-DA</b>	-

Infinite Pro Opticell 1700mm Surface	Infinite Pro Opticell 1700mm Recessed	Infinite Pro Opticell 1136mm Up&Down	Infinite Pro Opticell 1700mm Up&Down
			

### Accesorios de fijación requeridos

### Acessórios de fixação requeridos

	Florón suspendido con toma de corriente ON-OFF	14 ○	-	-	<b>71-7520-14-00</b>	-
	Florão suspenso com tomada de corrente ON-OFF	60 ●	-	-	-	<b>71-7520-60-00</b>
		N3 ○	-	-	-	<b>71-7520-N3-00</b>

	Florón suspendido con toma de corriente DALI	14 ○	-	-	<b>71-7521-14-00</b>	-
	Florão suspenso com tomada de corrente DALI	60 ●	-	-	-	<b>71-7521-60-00</b>

### Accesorios de fijación

### Acessórios de fixação

	Accesorio para instalación en pared	14 ○	<b>71-7518-14-00</b>	-	<b>71-7518-14-00</b>	-
	Acessório para instalação na parede	60 ●	-	-	-	<b>71-7518-60-00</b>
		N3 ○	-	-	-	<b>71-7518-N3-00</b>

### Accesorios de unión

### Acessórios de união

	Unión 90° ON-OFF	14 ○	<b>71-8113-14-00</b>	<b>71-8112-14-00</b>	-	-
	União 90° ON-OFF	N3 ○	-	-	-	-

Unión 90° DALI	<b>71-8113-14-DA</b>	<b>71-8112-14-DA</b>	-	-
União 90° DALI				

	Kit unión "I" DALI		<b>71-A955-00-DA</b>	<b>71-A955-00-DA</b>	<b>71-A956-00-DA</b>	<b>71-A956-00-DA</b>
	Kit união "I" DALI					

	Kit unión "I" ON-OFF		<b>71-A955-00-00</b>	<b>71-A955-00-00</b>	<b>71-A956-00-00</b>	<b>71-A956-00-00</b>
	Kit união "I" ON-OFF					

### Accesorios de conexión

### Acessórios de conexão

	Kit unión DALI		-	-	<b>71-8246-00-DA</b>	<b>71-8246-00-DA</b>
	Kit união DALI					











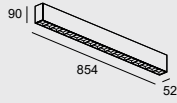

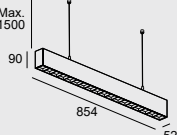

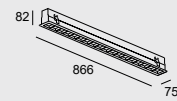







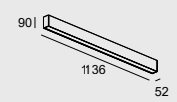

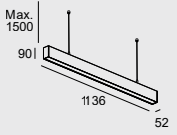

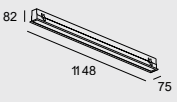

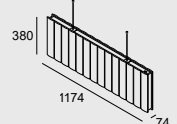







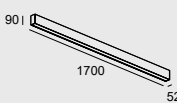

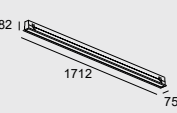
# Infinite Pro

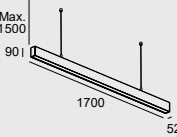
## Infinite Pro Hexa-Cell



Ejemplo de código / Exemplo de código: **AK11-15W8HCOS14**

INDOOR

Model	W	K / CRI / Real lm	Optics	Source	Finishes		
<b>854 mm</b>  <b>AK11 - Superficie Superficie</b>   <b>AK12 - Suspendeda Suspensa</b>   <b>AK13 - Empotrada Encastrada</b> 0-25 mm 860x65 	<b>15</b> 13.4W <b>26</b> 25.3W <b>26</b> 26.6W	<b>W8</b> 3000K / CRI 80 / 609 lm <b>W9</b> 3000K / CRI 90 / 480 lm <b>X8</b> 4000K / CRI 80 / 648 lm <b>X9</b> 4000K / CRI 90 / 499 lm <b>W8</b> 3000K / CRI 80 / 984 lm <b>W9</b> 3000K / CRI 90 / 879 lm <b>X8</b> 4000K / CRI 80 / 1047 lm <b>X9</b> 4000K / CRI 90 / 807 lm <b>U8</b> TW 2700K-6500K / CRI 80 / 1012 lm	<b>HC</b> Hexa-Cell 	<b>OS</b> ON-OFF 220-240V <b>DS</b> DALI 220-240V <b>OS</b> ON-OFF 220-240V <b>DS</b> DALI 220-240V <b>WR</b> (SC) DALI D4i 220-240V <b>XB</b> (S) CASAMBI 220-240V <b>TW</b> DALI DT8 220-240V <b>XC</b> (S) CASAMBI + TW 220-240V	<b>14</b>  <b>N3</b>  <b>60</b>  <b>GA</b>  <b>GB</b> 		
	<b>1136 mm</b>  <b>AK14 - Superficie Superficie</b>   <b>AK15 - Suspendeda Suspensa</b>   <b>AK16 - Empotrada Encastrada</b> 0-25 mm 1140x65   <b>AK23 - Suspendeda / Acústica Suspensa / Acústica</b> 	<b>2P</b> 17.9W <b>34</b> 33.7W <b>35</b> 35.5W	<b>W8</b> 3000K / CRI 80 / 790 lm <b>W9</b> 3000K / CRI 90 / 623 lm <b>X8</b> 4000K / CRI 80 / 841 lm <b>X9</b> 4000K / CRI 90 / 648 lm <b>W8</b> 3000K / CRI 80 / 1290 lm <b>W9</b> 3000K / CRI 90 / 1152 lm <b>X8</b> 4000K / CRI 80 / 1373 lm <b>X9</b> 4000K / CRI 90 / 1058 lm <b>U8</b> TW 2700K-6500K / CRI 80 / 1347 lm	<b>HC</b> Hexa-Cell 	<b>OS</b> ON-OFF 220-240V <b>OU</b> ON-OFF 100-277V <b>DS</b> DALI 220-240V <b>OS</b> ON-OFF 220-240V <b>OU</b> ON-OFF 100-277V <b>DS</b> DALI-2 220-240V <b>WR</b> (SC) DALI D4i 220-240V <b>XB</b> (S) CASAMBI 220-240V <b>TW</b> DALI DT8 220-240V <b>XA</b> (SC) DALI D4i + TW 220-240V <b>XC</b> (S) CASAMBI + TW 220-240V	<b>14</b>  <b>60</b>  <b>N3</b>  <b>14</b>  <b>GA</b>  <b>GB</b> 	
		<b>1700 mm</b>  <b>AK18 - Superficie Superficie</b>   <b>AK19 - Empotrada Encastrada</b> 0-25 mm 1705x65   <b>AK21 - Suspendeda Suspensa</b> 	<b>3P</b> 28.4W <b>52</b> 50.6W <b>53</b> 53.3W	<b>W8</b> 3000K / CRI 80 / 1197 lm <b>W9</b> 3000K / CRI 90 / 943 lm <b>X8</b> 4000K / CRI 80 / 1274 lm <b>X9</b> 4000K / CRI 90 / 982 lm <b>W8</b> 3000K / CRI 80 / 1965 lm <b>W9</b> 3000K / CRI 90 / 1755 lm <b>X8</b> 4000K / CRI 80 / 2091 lm <b>X9</b> 4000K / CRI 90 / 1611 lm <b>U8</b> TW 2700K-6500K / CRI 80 / 2024 lm	<b>HC</b> Hexa-Cell 	<b>OS</b> ON-OFF 220-240V <b>DS</b> DALI 220-240V <b>OS</b> ON-OFF 220-240V <b>DS</b> DALI 220-240V <b>WR</b> (SC) DALI D4i 220-240V/50-60Hz <b>XB</b> (S) CASAMBI 220-240V <b>TW</b> DALI DT8 220-240V <b>XA</b> DALI D4i + TW 220-240V <b>XC</b> (S) CASAMBI + TW 220-240V	<b>14</b>  <b>60</b>  <b>N3</b>  <b>14</b>  <b>60</b>  <b>N3</b> 











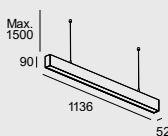

















SISTEMAS LINEALES | SISTEMAS LINEALES

# Infinite Pro

## Infinite Pro Up&Down Hexa-Cell



Ejemplo de código / Exemplo de código: **AK24-2PWBHCOS14**

Model	W	K / CRI / Real lm		Optics	Source	Finishes					
		↑UP	↓DOWN								
<b>AK24 -</b> Suspendida / Up&Down Suspensa / Up&Down   	<b>2P</b> 26.5W↑ 17W↓	<b>WB</b>	3000K / CRI 80 / 4655 lm	3000K / CRI 90 / 4655 lm	<b>HC</b> Hexa-Cell 	<b>OS</b>	 ON-OFF 220-240V	<b>14</b>  <b>N3</b>  <b>60</b> 			
		<b>XB</b>	4000K / CRI 80 / 4938 lm	4000K / CRI 90 / 4938 lm			<b>DS</b>		 DALI 220-240V		
		<b>QB</b>	3000K / CRI 80 / 4680 lm	4000K / CRI 90 / 4680 lm		<b>OS</b>			 ON-OFF 220-240V		
		<b>RB</b>	4000K / CRI 80 / 4913 lm	3000K / CRI 90 / 4913 lm			<b>OU</b>		 ON-OFF 100-277V		
		<b>34</b> 26.5W↑ 30.3W↓	<b>WB</b>	3000K / CRI 80 / 5184 lm					3000K / CRI 90 / 5184 lm	<b>HC</b> Hexa-Cell 	<b>DS</b>
			<b>XB</b>	4000K / CRI 80 / 5348 lm			4000K / CRI 90 / 5348 lm		<b>WR</b>		
	<b>QB</b>		3000K / CRI 80 / 5090 lm	4000K / CRI 90 / 5090 lm	<b>TW</b>	 DALI DT8 220-240V					
	<b>RB</b>		4000K / CRI 80 / 5442 lm	3000K / CRI 90 / 5442 lm		<b>XA</b>	 DALI D4i + TW 220-240V				
	<b>35</b> 25.3W↑ 33.8W↓		<b>U8</b>	TW 2700K - 6500K / CRI 80 / 4433 lm			<b>HC</b> Hexa-Cell 	<b>OS</b>	 ON-OFF 220-240V		
				<b>OS</b>		 ON-OFF 220-240V					
		<b>DS</b>			 DALI 220-240V						
					<b>WR</b>	 DALI D4i 220-240V					
<b>52</b> 41.7W↑ 45.5W↓		<b>WB</b>				3000K / CRI 80 / 8091 lm		<b>HC</b> Hexa-Cell 	<b>OS</b>	 ON-OFF 220-240V	
				<b>XB</b>	4000K / CRI 80 / 8352 lm					<b>DS</b>	 DALI 220-240V
	<b>QB</b>		3000K / CRI 80 / 8091 lm		<b>WR</b>	 DALI D4i 220-240V					
			<b>RB</b>	4000K / CRI 80 / 8091 lm		<b>XB</b>	 CASAMBI 220-240V				
	<b>53</b> 42.2W↑ 50.7W↓	<b>U8</b>		TW 2700K - 6500K / CRI 80 / 7157 lm			<b>HC</b> Hexa-Cell 		<b>TW</b>	 DALI DT8 220-240V	
			<b>XA</b>	 DALI D4i + TW 220-240V							
<b>XC</b>	 CASAMBI + TW 220-240V										

Infinite Pro  
Hexa-Cell 854mm  
SurfaceInfinite Pro Hexa-Cell 1700mm  
SuspendedInfinite Pro  
Hexa-Cell 854mm  
SuspendedInfinite Pro  
Hexa-Cell 854mm  
Recessed

### Sensores

#### Sensores

P. 1166

	Sensor DALI D4i Connected Sensor DALI D4i Connected	14 ○	-	<b>71-7735-14-SE</b>	-	-
		60 ●	-	-	<b>71-7735-60-SE</b>	-
	Sensor DALI D4i One Sensor DALI D4i One	14 ○	-	<b>71-A263-14-SE</b>	-	-
		60 ●	-	-	<b>71-A263-60-SE</b>	-

### Accesorios de fijación requeridos

#### Accesórios de fixação requeridos

	Florón suspendido con toma de corriente ON-OFF Florão suspenso com tomada de corrente ON-OFF	14 ○	-	<b>71-7520-14-00</b>	-	-	
		60 ●	-	-	-	-	-
		N3 ○	-	-	<b>71-7520-N3-00</b>	-	-
	Florón suspendido con toma de corriente DALI Florão suspenso com tomada de corrente DALI	14 ○	-	<b>71-7521-14-00</b>	-	-	
		60 ●	-	-	<b>71-7521-60-00</b>	-	-
		N3 ○	-	-	-	-	-

### Accesorios de fijación

#### Accesórios de fixação

	Accesorio para instalación en pared Acessório para instalação na parede	14 ○	<b>71-7518-14-00</b>	-	-	-	
		60 ●	-	-	-	-	-
		N3 ○	-	-	-	-	-

### Accesorios de unión

#### Accesórios de união

	Unión 90° ON-OFF União 90° ON-OFF	14 ○	<b>71-8113-14-00</b>	<b>71-8113-14-00</b>	-	<b>71-8112-14-00</b>
		N3 ○	-	-	<b>71-8113-N3-00</b>	-
	Unión 90° DALI União 90° DALI	14 ○	<b>71-8113-14-DA</b>	<b>71-8113-14-DA</b>	-	<b>71-8112-14-DA</b>
		60 ●	-	-	<b>71-8113-60-DA</b>	-
	Kit unión "I" ON-OFF Kit união "I" ON-OFF		<b>71-A955-00-00</b>	<b>71-A955-00-00</b>	<b>71-A955-00-00</b>	<b>71-A955-00-00</b>
			<b>71-A955-00-DA</b>	<b>71-A955-00-DA</b>	<b>71-A955-00-DA</b>	<b>71-A955-00-DA</b>
	Kit unión "I" DALI Kit união "I" DALI		<b>71-A955-00-DA</b>	<b>71-A955-00-DA</b>	<b>71-A955-00-DA</b>	<b>71-A955-00-DA</b>
			<b>71-A955-00-DA</b>	<b>71-A955-00-DA</b>	<b>71-A955-00-DA</b>	<b>71-A955-00-DA</b>

### Accesorios de conexión

#### Accesórios de conexão

	Kit unión DALI Kit união DALI		-	<b>71-8246-00-DA</b>	<b>71-8246-00-DA</b>	<b>71-8246-00-DA</b>
			-	<b>71-8246-00-DA</b>	<b>71-8246-00-DA</b>	<b>71-8246-00-DA</b>



**Infinite Pro  
Hexa-Cell 1136mm  
Surface**

**Infinite Pro  
Hexa-Cell 1136mm  
Pendant**

**Infinite Pro  
Hexa-Cell 1136mm  
Acoustic Pendant**

**Infinite Pro  
Hexa-Cell 1700mm  
Surface**

**Sensores  
Sensores**

P. 1166



Sensor DALI D4i Connected  
Sensor DALI D4i Connected

14 ○

-

**71-7735-14-SE**

-

-

60 ●

-

-

-

-



Sensor DALI D4i One  
Sensor DALI D4i One

14 ○

-

**71-A263-14-SE**

-

-

60 ●

-

-

-

-

**Accesorios de fijación requeridos  
Acessórios de fixação requeridos**

Florón suspenso con toma  
de corriente ON-OFF  
Florão suspenso com tomada  
de corrente ON-OFF

14 ○

-

**71-7520-14-00**

-

-

60 ●

-

-

-

-

N3 ○

-

-

-

-



Florón suspenso con toma  
de corriente DALI  
Florão suspenso com tomada  
de corrente DALI

14 ○

-

**71-7521-14-00**

-

-

60 ●

-

-

-

-

N3 ○

-

-

-

-

**Accesorios de fijación  
Acessórios de fixação**

Accesorio para instalación en  
pared  
Acessório para instalação na  
parede

14 ○

**71-7518-14-00**

-

-

**71-7518-14-00**

60 ●

-

-

-

-

N3 ○

-

-

-

-

**Accesorios de unión  
Acessórios de união**

Unión 90° ON-OFF  
União 90° ON-OFF

14 ○

**71-8113-14-00****71-8113-14-00**

-

**71-8113-14-00**

N3 ○

-

-

-

-



Unión 90° DALI  
União 90° DALI

14 ○

**71-8113-14-DA****71-8113-14-DA**

-

**71-8113-14-DA**

60 ●

-

-

-

-



Kit unión "I" ON-OFF  
Kit união "I" ON-OFF

**71-A955-00-00****71-A955-00-00**

-

**71-A955-00-00**

Kit unión "I" DALI  
Kit união "I" DALI

**71-A955-00-DA****71-A955-00-DA**

-

**71-A955-00-DA**
**Accesorios de conexión  
Acessórios de conexão**

Kit unión DALI  
Kit união DALI

-

**71-8246-00-DA**

-

-

Infinite Pro  
Hexa-Cell 1700mm  
Recessed

Infinite Pro  
Hexa-Cell 1136mm  
Up&Down

Infinite Pro  
Hexa-Cell 1700mm  
Up&Down



## Sensores Sensores

P. 1166



Sensor DALI D4i Connected  
Sensor DALI D4i Connected

14 ○

-

-

-

60 ●

-

-

-



Sensor DALI D4i One  
Sensor DALI D4i One

14 ○

-

-

-

60 ●

-

-

-

## Accesorios de fijación requeridos Acessórios de fixação requeridos



Florón suspendido con toma de corriente ON-OFF  
Florão suspenso com tomada de corrente ON-OFF

14 ○

-

**71-7520-14-00**

-

60 ●

-

-

**71-7520-60-00**

N3 ○

-

-

-



Florón suspendido con toma de corriente DALI  
Florão suspenso com tomada de corrente DALI

14 ○

-

**71-7521-14-00**

-

60 ●

-

-

**71-7521-60-00**

N3 ○

-

**71-7521-N3-00**

-

## Accesorios de fijación Acessórios de fixação



Accesorio para instalación en pared  
Acessório para instalação na parede

14 ○

-

**71-7518-14-00**

-

60 ●

-

-

**71-7518-60-00**

N3 ○

-

**71-7518-N3-00**

-

## Accesorios de unión Acessórios de união



Unión 90° ON-OFF  
União 90° ON-OFF

14 ○

**71-8112-14-00**

-

-

N3 ○

-

-

-



Unión 90° DALI  
União 90° DALI

14 ○

**71-8112-14-DA**

-

-

60 ●

-

-

-



Kit unión "I" ON-OFF  
Kit união "I" ON-OFF

**71-A955-00-00****71-A956-00-00****71-A956-00-00**

Kit unión "I" DALI  
Kit união "I" DALI

**71-A955-00-DA****71-A956-00-DA****71-A956-00-DA**

## Accesorios de conexión Acessórios de conexão



Kit unión DALI  
Kit união DALI

**71-8246-00-DA****71-8246-00-DA****71-8246-00-DA**

# Infinite Pro

## Infinite Pro Haloprisma

IP
40

BODY MAT
AL

UGR
<19

DIF MAT
PC









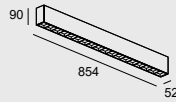
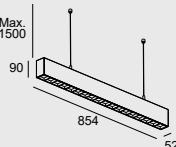
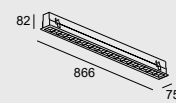

50000h
L80 B20

3
MacAdam

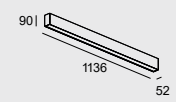
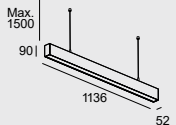
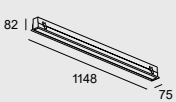
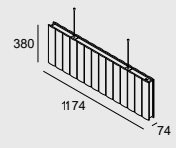

Ejemplo de código / Exemplo de código: **AK11-1PW8HPOS14**

Model	W	K / CRI / Real lm	Optics	Source	Finishes						
<b>854 mm</b>  <b>AK11 - Superficie Superficie</b> 14 60 N3  <b>AK12 - Suspendida Suspensa</b> 14 60 N3  <b>AK13 - Empotrada Encastrada</b> 0-25 mm 14 860x65	<b>1P</b> 10W	<b>W8</b> 3000K / CRI 80 / 1739 lm <b>W9</b> 3000K / CRI 90 / 1370 lm <b>X8</b> 4000K / CRI 80 / 1850 lm <b>X9</b> 4000K / CRI 90 / 1426 lm	<b>HP</b> Haloprisma 	<b>OS</b> ON-OFF 220-240V <b>DS</b> DALI 220-240V <b>XB</b> CASAMBI 220-240V	<b>14</b>  <b>N3</b>  <b>60</b>  <b>GA</b>  <b>GB</b> 						
						<b>1136 mm</b>  <b>AK14 - Superficie Superficie</b> 14 60 N3  <b>AK15 - Suspendida Suspensa</b> 14 60 N3  <b>AK16 - Empotrada Encastrada</b> 0-25 mm 14 1140x65  <b>AK23 - Suspendida / Acústica Suspensa / Acústica</b> GA GB	<b>13</b> 14.1W	<b>W8</b> 3000K / CRI 80 / 2264 lm <b>W9</b> 3000K / CRI 90 / 1783 lm <b>X8</b> 4000K / CRI 80 / 2409 lm <b>X9</b> 4000K / CRI 90 / 1856 lm	<b>HP</b> Haloprisma 	<b>OS</b> ON-OFF 220-240V <b>DS</b> DALI 220-240V <b>WR</b> DALI D4i 220-240V <b>XB</b> CASAMBI 220-240V	

# Infinite Pro

## Infinite Pro Up&Down Haloprisma

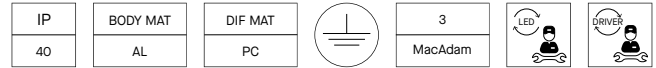

Ejemplo de código / Exemplo de código: **AK24-13WBHPOS14**

Model	W	K / CRI / Real lm		Optics	Source	Finishes				
<b>1136 mm</b>  <b>AK24 -</b> Suspendida / Up&Down Suspensa / Up&Down IP40  	<b>13</b> 26.5W↑ 12.6W↓	<b>WB</b> 3000K / CRI 80 / 5815 lm <b>XB</b> 4000K / CRI 80 / 6146 lm <b>QB</b> 3000K / CRI 80 / 5888 lm <b>RB</b> 4000K / CRI 80 / 6073 lm	↑UP 3000K / CRI 90 / 5815 lm ↓DOWN 3000K / CRI 90 / 5815 lm	<b>HP</b> Haloprisma 	<b>OS</b> ON-OFF 220-240V <b>DS</b> DALI 220-240V <b>WR</b> DALI D4i 220-240V	<b>14</b> <b>N3</b> <b>60</b>				
			<b>1700 mm</b>  <b>AK25 -</b> Suspendida / Up&Down Suspensa / Up&Down IP40  		<b>19</b> 41.7W↑ 19W↓		<b>WB</b> 3000K / CRI 80 / 8119 lm <b>XB</b> 4000K / CRI 80 / 8597 lm <b>QB</b> 3000K / CRI 80 / 8192 lm <b>RB</b> 4000K / CRI 80 / 8524 lm	↑UP 3000K / CRI 90 / 8119 lm ↓DOWN 3000K / CRI 90 / 8119 lm	<b>HP</b> Haloprisma 	<b>OS</b> ON-OFF 220-240V <b>DS</b> DALI 220-240V <b>WR</b> DALI D4i 220-240V <b>XB</b> CASAMBI 220-240V

Infinite Pro Haloprisma  
854mm SurfaceInfinite Pro Haloprisma  
1700mm SuspendedInfinite Pro Haloprisma  
854mm Suspended**Sensores**  
Sensores

P. 1166

Sensor DALI D4i Connected  
Sensor DALI D4i Connected

-

**71-7735-14-SE**

-

Sensor DALI D4i One  
Sensor DALI D4i One

-

**71-A263-14-SE**

-

**Accesorios de fijación requeridos**  
Acessórios de fixação requeridosFlorón suspendido con toma  
de corriente ON-OFF  
Florão suspenso com tomada  
de corrente ON-OFF

14 ○

-

**71-7520-14-00**

-

60 ●

-

-

**71-7520-60-00**

N3 ●

-

-

-

Florón suspendido con toma  
de corriente DALI  
Florão suspenso com tomada  
de corrente DALI

14 ○

-

**71-7521-14-00**

-

60 ●

-

-

-

N3 ●

-

-

-

**Accesorios de fijación**  
Acessórios de fixaçãoAccesorio para instalación en  
pared  
Acessório para instalação na  
parede

14 ○

**71-7518-14-00**

-

-

60 ●

-

-

-

N3 ●

**71-7518-N3-00**

-

-

**Accesorios de unión**  
Acessórios de uniãoUnión 90° ON-OFF  
União 90° ON-OFF

14 ○

**71-8113-14-00****71-8113-14-00**

-

60 ●

-

-

**71-8113-60-00**Unión 90° DALI  
União 90° DALI

14 ○

-

**71-8113-14-DA**

-

N3 ●

**71-8113-N3-DA**

-

-

Kit unión "I" ON-OFF  
Kit união "I" ON-OFF**71-A955-00-00****71-A955-00-00****71-A955-00-00**Kit unión "I" DALI  
Kit união "I" DALI**71-A955-00-DA****71-A955-00-DA****71-A955-00-DA****Accesorios de conexión**  
Acessórios de conexãoKit unión DALI  
Kit união DALI

-

**71-8246-00-DA**

-

Infinite Pro Haloprisma  
854mm Recessed

Infinite Pro Haloprisma  
1136mm Surface

Infinite Pro Haloprisma  
1136mm Suspended



**Sensores**  
Sensores

P. 1166



Sensor DALI D4i Connected  
Sensor DALI D4i Connected

-

-

-



Sensor DALI D4i One  
Sensor DALI D4i One

-

-

-

**Accesorios de fijación requeridos**  
Acessórios de fixação requeridos



Florón suspendido con toma  
de corriente ON-OFF  
Florão suspenso com tomada  
de corrente ON-OFF

14 ○

-

-

-

60 ●

-

-

-

N3 ●

-

-

-



Florón suspendido con toma  
de corriente DALI  
Florão suspenso com tomada  
de corrente DALI

14 ○

-

-

**71-7521-14-00**

60 ●

-

-

-

N3 ●

-

-

-

**Accesorios de fijación**  
Acessórios de fixação



Accesorio para instalación en  
pared  
Acessório para instalação na  
parede

14 ○

-

**71-7518-14-00**

-

60 ●

-

-

-

N3 ●

-

-

-

**Accesorios de unión**  
Acessórios de união



Unión 90° ON-OFF  
União 90° ON-OFF

14 ○

**71-8112-14-00**

**71-8113-14-00**

-

60 ●

-

-

-



Unión 90° DALI  
União 90° DALI

14 ○

-

-

**71-8113-14-DA**

N3 ●

-

-

-



Kit unión "I" ON-OFF  
Kit união "I" ON-OFF

**71-A955-00-00**

**71-A955-00-00**

**71-A955-00-00**



Kit unión "I" DALI  
Kit união "I" DALI

**71-A955-00-DA**

**71-A955-00-DA**

**71-A955-00-DA**

**Accesorios de conexión**  
Acessórios de conexão



Kit unión DALI  
Kit união DALI

-

-

-

**Infinite Pro Haloprisma  
1136mm Recessed**

**Infinite Pro Haloprisma  
1136mm Suspended  
Acoustic**

**Infinite Pro Haloprisma  
1700mm Surface**

**Sensores**  
Sensores

P. 1166

 Sensor DALI D4i Connected  
Sensor DALI D4i Connected

-

-

-

 Sensor DALI D4i One  
Sensor DALI D4i One

-

-

-

**Accesorios de fijación requeridos**  
Acessórios de fixação requeridos

 Florón suspendido con toma  
de corriente ON-OFF  
Florão suspenso com tomada  
de corrente ON-OFF

14 ○

-

-

-

60 ●

-

-

-

N3 ●

-

-

-

 Florón suspendido con toma  
de corriente DALI  
Florão suspenso com tomada  
de corrente DALI

14 ○

-

-

-

60 ●

-

-

-

N3 ●

-

-

-

**Accesorios de fijación**  
Acessórios de fixação

 Accesorio para instalación en  
pared  
Acessório para instalação na  
parede

14 ○

-

-

**71-7518-14-00**

60 ●

-

-

-

N3 ●

-

-

-

**Accesorios de unión**  
Acessórios de união

 Unión 90° ON-OFF  
União 90° ON-OFF

14 ○

-

-

**71-8113-14-00**

60 ●

-

-

-

 Unión 90° DALI  
União 90° DALI

14 ○

**71-8112-14-DA**

-

-

N3 ●

-

-

-

 Kit unión "I" ON-OFF  
Kit união "I" ON-OFF
**71-A955-00-00**

-

**71-A955-00-00**
 Kit unión "I" DALI  
Kit união "I" DALI
**71-A955-00-DA**

-

**71-A955-00-DA**
**Accesorios de conexión**  
Acessórios de conexão

 Kit unión DALI  
Kit união DALI
**71-8246-00-DA**

-

-



Infinite Pro Haloprisma  
1700mm Recessed



Infinite Pro Haloprisma  
1136mm Up&Down



Infinite Pro Haloprisma  
1700mm Up&Down



## Sensores Sensores

P. 1166



Sensor DALI D4i Connected  
Sensor DALI D4i Connected

-

-

-



Sensor DALI D4i One  
Sensor DALI D4i One

-

-

-

## Accesorios de fijación requeridos Acessórios de fixação requeridos



Florón suspendido con toma  
de corriente ON-OFF  
Florão suspenso com tomada  
de corrente ON-OFF

14 ○

-

**71-7520-14-00**

-

60 ●

-

-

**71-7520-60-00**

N3 ○

-

-

**71-7520-N3-00**



Florón suspendido con toma  
de corriente DALI  
Florão suspenso com tomada  
de corrente DALI

14 ○

-

**71-7521-14-00**

-

60 ●

-

-

**71-7521-60-00**

N3 ○

-

-

**71-7521-N3-00**

## Accesorios de fijación Acessórios de fixação



Accesorio para instalación en  
pared  
Acessório para instalação na  
parede

14 ○

-

**71-7518-14-00**

-

60 ●

-

-

**71-7518-60-00**

N3 ○

-

-

**71-7518-N3-00**

## Accesorios de unión Acessórios de união



Unión 90° ON-OFF  
União 90° ON-OFF

14 ○

-

-

-

60 ●

-

-

-



Unión 90° DALI  
União 90° DALI

14 ○

**71-8112-14-DA**

-

-

N3 ○

-

-

-



Kit unión "I" ON-OFF  
Kit união "I" ON-OFF

**71-A955-00-00**

**71-A956-00-00**

**71-A956-00-00**



Kit unión "I" DALI  
Kit união "I" DALI

**71-A955-00-DA**

**71-A956-00-DA**

**71-A956-00-DA**

## Accesorios de conexión Acessórios de conexão



Kit unión DALI  
Kit união DALI

-

**71-8246-00-DA**

**71-8246-00-DA**

# Infinite Pro

## Infinite Pro Opal

IP
40

BODY MAT
AL

DIF MAT
PC











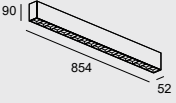
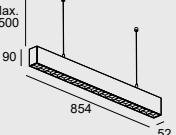
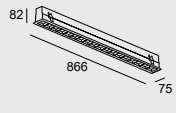

50000h
L80 B20

3
MacAdam

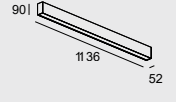
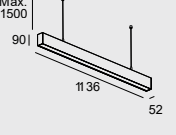
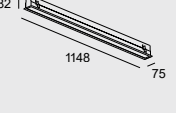
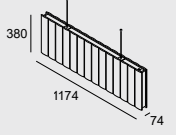

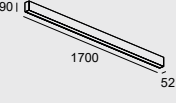
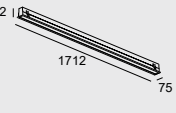
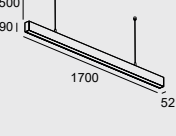
Ejemplo de código / Exemplo de código: **AK11-15W8PMOS14**

Model	W	K / CRI / Real lm	Optics	Source	Finishes				
<b>854 mm</b>  <b>AK11 - Superficie Superficie</b> 14 60 N3  <b>AK12 - Suspendida Suspensa</b> 14 60 N3  <b>AK13 - Empotrada Encastrada</b> 0-25 mm 860x65 14	<b>15</b> 13.4W	<b>W8</b> 3000K / CRI 80 / 1748 lm <b>W9</b> 3000K / CRI 90 / 1377 lm <b>X8</b> 4000K / CRI 80 / 1860 lm <b>X9</b> 4000K / CRI 90 / 1433 lm	<b>PM</b> Opal 	<b>OS</b> ON-OFF 220-240V <b>DS</b> DALI 220-240V	<b>14</b>  <b>N3</b>  <b>60</b>  <b>GA</b>  <b>GB</b> 				
	<b>26</b> 25.3W	<b>W8</b> 3000K / CRI 80 / 2944 lm <b>W9</b> 3000K / CRI 90 / 2629 lm <b>X8</b> 4000K / CRI 80 / 3132 lm <b>X9</b> 4000K / CRI 90 / 2414 lm		<b>OS</b> ON-OFF 220-240V <b>DS</b> DALI 220-240V <b>WR</b> DALI D4i 220-240V <b>XB</b> CASAMBI 220-240V					
	<b>26</b> 26.6W	<b>U8</b> TW 2700K-6500K / CRI 80 / 2904 lm		<b>TW</b> DALI DT8 220-240V <b>XC</b> CASAMBI + TW 220-240V					
	<b>1136 mm</b>  <b>AK14 - Superficie Superficie</b> 14 60 N3  <b>AK15 - Suspendida Suspensa</b> 14 60 N3  <b>AK16 - Empotrada Encastrada</b> 0-25 mm 1140x65 14  <b>AK23 - Suspendida / Acústica Suspensa / Acústica</b> GA GB	<b>2P</b> 17.9W		<b>W8</b> 3000K / CRI 80 / 2276 lm <b>W9</b> 3000K / CRI 90 / 1793 lm <b>X8</b> 4000K / CRI 80 / 2422 lm <b>X9</b> 4000K / CRI 90 / 1866 lm		<b>PM</b> Opal 	<b>OS</b> ON-OFF 220-240V <b>OU</b> ON-OFF 100-277V <b>DS</b> DALI 220-240V		
		<b>34</b> 33.7W		<b>W8</b> 3000K / CRI 80 / 3834 lm <b>W9</b> 3000K / CRI 90 / 3424 lm <b>X8</b> 4000K / CRI 80 / 4079 lm <b>X9</b> 4000K / CRI 90 / 3143 lm			<b>OS</b> ON-OFF 220-240V <b>OU</b> ON-OFF 100-277V <b>DS</b> DALI-2 220-240V <b>WR</b> DALI D4i 220-240V <b>XB</b> CASAMBI 220-240V		
		<b>35</b> 35.5W		<b>U8</b> TW 2700K-6500K / CRI 80 / 3877 lm			<b>TW</b> DALI DT8 220-240V <b>XA</b> DALI D4i + TW 220-240V <b>XC</b> CASAMBI + TW 220-240V		
		<b>1700 mm</b>  <b>AK18 - Superficie Superficie</b> 14 60 N3  <b>AK19 - Empotrada Encastrada</b> 0-25 mm 1705x65 14  <b>AK21 - Suspendida Suspensa</b> 14 60 N3		<b>3P</b> 28.4W			<b>W8</b> 3000K / CRI 80 / 3496 lm <b>W9</b> 3000K / CRI 90 / 2753 lm <b>X8</b> 4000K / CRI 80 / 3720 lm <b>X9</b> 4000K / CRI 90 / 2866 lm	<b>PM</b> Opal 	<b>OS</b> ON-OFF 220-240V <b>DS</b> DALI 220-240V
				<b>52</b> 50.6W			<b>W8</b> 3000K / CRI 80 / 5888 lm <b>W9</b> 3000K / CRI 90 / 5258 lm <b>X8</b> 4000K / CRI 80 / 6264 lm <b>X9</b> 4000K / CRI 90 / 4827 lm		<b>OS</b> ON-OFF 220-240V <b>DS</b> DALI 220-240V <b>WR</b> DALI D4i 220-240V/50-60Hz <b>XB</b> CASAMBI 220-240V
				<b>53</b> 53.3W			<b>U8</b> TW 2700K-6500K / CRI 80 / 5909 lm		<b>TW</b> DALI DT8 220-240V <b>XA</b> DALI D4i + TW 220-240V <b>XC</b> CASAMBI + TW 220-240V

# Infinite Pro

## Infinite Pro Up&Down Opal

IP
40

BODY MAT
AL

DIF MAT
PC











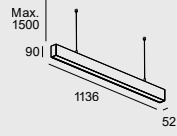



















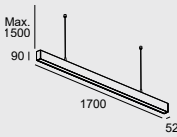









3
MacAdam







Ejemplo de código / Exemplo de código: **AK24-2PWBPMS14**

INDOOR

Model	W	K / CRI / Real lm		Optics	Source	Finishes						
		↑UP	↓DOWN									
<b>AK24 -</b> Suspendida / Up&Down Suspensa / Up&Down    1136 mm	<b>2P</b> 26.5W↑ 17W↓	<b>WB</b>	3000K / CRI 80 / 5825 lm	3000K / CRI 90 / 5825 lm	<b>PM</b> Opal 	<b>OS</b>  ON-OFF 220-240V	<b>14</b>  <b>N3</b>  <b>60</b> 					
		<b>XB</b>	4000K / CRI 80 / 6156 lm	4000K / CRI 90 / 6156 lm				<b>DS</b>  DALI 220-240V				
		<b>QB</b>	3000K / CRI 80 / 5898 lm	4000K / CRI 90 / 5898 lm								
		<b>RB</b>	4000K / CRI 80 / 6083 lm	3000K / CRI 90 / 6083 lm								
	<b>34</b> 26.5W↑ 30.3W↓	<b>WB</b>	3000K / CRI 80 / 7456 lm	3000K / CRI 90 / 7456 lm	<b>PM</b> Opal 	<b>OS</b>  ON-OFF 220-240V						
		<b>XB</b>	4000K / CRI 80 / 7433 lm	4000K / CRI 90 / 7433 lm				<b>OU</b>  ON-OFF 100-277V				
		<b>QB</b>	3000K / CRI 80 / 7175 lm	4000K / CRI 90 / 7175 lm				<b>DS</b>  DALI 220-240V				
		<b>RB</b>	4000K / CRI 80 / 7714 lm	3000K / CRI 90 / 7714 lm				<b>WR</b>   DALI D4i 220-240V				
		<b>35</b> 25.3W↑ 33.8W↓	<b>U8</b>	TW 2700K - 6500K / CRI 80 / 6963 lm				TW 2700K - 6500K / CRI 80 / 6963 lm	<b>PM</b> Opal 	<b>OS</b>  ON-OFF 220-240V		
												<b>DS</b>  DALI 220-240V
												<b>TW</b>  DALI DT8 220-240V
												<b>XA</b>  DALI D4i + TW 220-240V
<b>AK25 -</b> Suspendida / Up&Down Suspensa / Up&Down   1700 mm	<b>3P</b> 41.7W↑ 25.6W↓	<b>WB</b>	3000K / CRI 80 / 9089 lm	3000K / CRI 90 / 9089 lm	<b>PM</b> Opal 	<b>OS</b>  ON-OFF 220-240V						
		<b>XB</b>	4000K / CRI 80 / 9607 lm	4000K / CRI 90 / 9607 lm				<b>DS</b>  DALI 220-240V				
		<b>QB</b>	3000K / CRI 80 / 9202 lm	4000K / CRI 90 / 9202 lm								
		<b>RB</b>	4000K / CRI 80 / 9494 lm	3000K / CRI 90 / 9494 lm								
	<b>52</b> 41.7W↑ 45.5W↓	<b>WB</b>	3000K / CRI 80 / 11594 lm	3000K / CRI 90 / 11594 lm	<b>PM</b> Opal 	<b>OS</b>  ON-OFF 220-240V						
								<b>DS</b>  DALI 220-240V				
								<b>WR</b>   DALI D4i 220-240V				
								<b>XB</b>   CASAMBI 220-240V				
	<b>53</b> 42.2W↑ 50.7W↓	<b>U8</b>	TW 2700K - 6500K / CRI 80 / 11042 lm	TW 2700K - 6500K / CRI 80 / 11042 lm	<b>PM</b> Opal 	<b>OS</b>  ON-OFF 220-240V						
								<b>XA</b>   DALI D4i + TW 220-240V				
								<b>XC</b>   CASAMBI + TW 220-240V				



SISTEMAS LINEALES | SISTEMAS LINEALES

Infinite Pro Opal 854mm Surface	Infinite Pro Opal 1700mm Suspended	Infinite Pro Opal 854mm Suspended	Infinite Pro Opal 854mm Recessed
			

## Sensores



### Sensores

P. 1166

	Sensor DALI D4i Connected Sensor DALI D4i Connected	14 ○	-	<b>71-7735-14-SE</b>	-	-
		60 ●	-	-	<b>71-7735-60-SE</b>	-
	Sensor DALI D4i One Sensor DALI D4i One	14 ○	-	<b>71-A263-14-SE</b>	-	-
		60 ●	-	-	<b>71-A263-60-SE</b>	-

## Accesorios de fijación requeridos

### Acessórios de fixação requeridos

	Florón suspendido con toma de corriente ON-OFF Florão suspenso com tomada de corrente ON-OFF	14 ○	-	<b>71-7520-14-00</b>	-	-
		60 ●	-	-	<b>71-7520-60-00</b>	-
		N3 ○	-	-	<b>71-7520-N3-00</b>	-
	Florón suspendido con toma de corriente DALI Florão suspenso com tomada de corrente DALI	14 ○	-	<b>71-7521-14-00</b>	-	-
		60 ●	-	-	<b>71-7521-60-00</b>	-
		N3 ○	-	-	-	-

## Accesorios ópticos

### Acessórios óticos

	Difusor microprismático Difusor microprismático		<b>71-A938-00-00</b>	<b>71-A940-00-00</b>	<b>71-A938-00-00</b>	<b>71-A938-00-00</b>
-------------------------------------------------------------------------------------	----------------------------------------------------	--	----------------------	----------------------	----------------------	----------------------



## Accesorios de fijación

### Acessórios de fixação

	Accesorio para instalación en pared Acessório para instalação na parede	14 ○	<b>71-7518-14-00</b>	-	-	-
		60 ●	-	-	-	-
		N3 ○	-	-	-	-

## Accesorios de unión

### Acessórios de união

	Unión 90° ON-OFF União 90° ON-OFF	14 ○	<b>71-8113-14-00</b>	<b>71-8113-14-00</b>	-	<b>71-8112-14-00</b>
		60 ●	-	-	<b>71-8113-60-00</b>	-
		N3 ○	-	-	<b>71-8113-N3-00</b>	-
	Unión 90° DALI União 90° DALI	14 ○	<b>71-8113-14-DA</b>	<b>71-8113-14-DA</b>	-	<b>71-8112-14-DA</b>
		60 ●	-	-	<b>71-8113-60-DA</b>	-
	Kit unión "I" DALI Kit união "I" DALI		<b>71-A955-00-DA</b>	<b>71-A955-00-DA</b>	<b>71-A955-00-DA</b>	<b>71-A955-00-DA</b>
	Kit unión "I" ON-OFF Kit união "I" ON-OFF		<b>71-A955-00-00</b>	<b>71-A955-00-00</b>	<b>71-A955-00-00</b>	<b>71-A955-00-00</b>

## Accesorios de conexión

### Acessórios de conexão

	Kit unión DALI Kit união DALI		-	<b>71-8246-00-DA</b>	<b>71-8246-00-DA</b>	<b>71-8246-00-DA</b>
-------------------------------------------------------------------------------------	----------------------------------	--	---	----------------------	----------------------	----------------------

Infinite Pro Opal  
1136mm Surface



Infinite Pro  
Opal 1136mm  
Suspended



Infinite Pro Opal  
1136mm Suspended.  
Acoustic





Infinite Pro Opal  
1700mm Surface





## Sensores Sensores

P. 1166

	Sensor DALI D4i Connected Sensor DALI D4i Connected	14	○	-	<b>71-7735-14-SE</b>	-	-
		60	●	-	-	-	-
	Sensor DALI D4i One Sensor DALI D4i One	14	○	-	<b>71-A263-14-SE</b>	-	-
		60	●	-	-	-	-

## Accesorios de fijación requeridos Acessórios de fixação requeridos

	Florón suspendido con toma de corriente ON-OFF Florão suspenso com tomada de corrente ON-OFF	14	○	-	<b>71-7520-14-00</b>	-	-
		60	●	-	-	-	-
		N3	○	-	-	-	-
	Florón suspendido con toma de corriente DALI Florão suspenso com tomada de corrente DALI	14	○	-	<b>71-7521-14-00</b>	-	-
		60	●	-	-	-	-
		N3	○	-	-	-	-



## Accesorios ópticos Acessórios óticos

	Difusor microprismático Difusor microprismático			<b>71-A939-00-00</b>	<b>71-A939-00-00</b>	<b>71-A939-00-00</b>	<b>71-A940-00-00</b>
-------------------------------------------------------------------------------------	----------------------------------------------------	--	--	----------------------	----------------------	----------------------	----------------------

## Accesorios de fijación Acessórios de fixação

	Accesorio para instalación en pared Acessório para instalação na parede	14	○	<b>71-7518-14-00</b>	-	-	<b>71-7518-14-00</b>
		60	●	-	-	-	-
		N3	○	-	-	-	-

## Accesorios de unión Acessórios de união

	Unión 90° ON-OFF União 90° ON-OFF	14	○	<b>71-8113-14-00</b>	<b>71-8113-14-00</b>	-	<b>71-8113-14-00</b>
		60	●	-	-	-	-
		N3	○	-	-	-	-
	Unión 90° DALI União 90° DALI	14	○	<b>71-8113-14-DA</b>	<b>71-8113-14-DA</b>	-	<b>71-8112-14-DA</b>
		60	●	-	-	-	-
	Kit unión "I" DALI Kit união "I" DALI			<b>71-A955-00-DA</b>	<b>71-A955-00-DA</b>	<b>71-A955-00-DA</b>	<b>71-A955-00-DA</b>
	Kit unión "I" ON-OFF Kit união "I" ON-OFF			<b>71-A955-00-00</b>	<b>71-A955-00-00</b>	<b>71-A955-00-00</b>	<b>71-A955-00-00</b>

## Accesorios de conexión Acessórios de conexão

	Kit unión DALI Kit união DALI			-	<b>71-8246-00-DA</b>	-	-
-------------------------------------------------------------------------------------	----------------------------------	--	--	---	----------------------	---	---

Infinite Pro  
Opal 1700mm  
RecessedInfinite Pro  
Opal 1136mm  
Up&DownInfinite Pro  
Opal 1700mm  
Up&Down**Sensores**  
Sensores

P. 1166

Sensor DALI D4i Connected  
Sensor DALI D4i Connected

14 ○

-

-

-

60 ●

-

-

-

Sensor DALI D4i One  
Sensor DALI D4i One

14 ○

-

-

-

60 ●

-

-

-

**Accesorios de fijación requeridos**  
Acessórios de fixação requeridosFlorón suspendido con toma de corriente ON-OFF  
Florão suspenso com tomada de corrente ON-OFF

14 ○

-

**71-7520-14-00**

-

60 ●

-

-

**71-7520-60-00**

N3 ○

-

-

-

Florón suspendido con toma de corriente DALI  
Florão suspenso com tomada de corrente DALI

14 ○

-

**71-7521-14-00**

-

60 ●

-

-

**71-7521-60-00**

N3 ○

-

**71-7521-N3-00**

-

**Accesorios ópticos**  
Acessórios óticosDifusor microprismático  
Difusor microprismático**71-A940-00-00****71-A939-00-00****71-A940-00-00****Accesorios de fijación**  
Acessórios de fixaçãoAccesorio para instalación en pared  
Acessório para instalação na parede

14 ○

-

**71-7518-14-00**

-

60 ●

-

-

**71-7518-60-00**

N3 ○

-

**71-7518-N3-00**

-

**Accesorios de unión**  
Acessórios de uniãoUnión 90° ON-OFF  
União 90° ON-OFF

14 ○

**71-8112-14-00**

-

-

60 ●

-

-

-

N3 ○

-

-

-

Unión 90° DALI  
União 90° DALI

14 ○

**71-8112-14-DA**

-

-

60 ●

-

-

-

Kit unión "I" DALI  
Kit união "I" DALI**71-A955-00-DA****71-A956-00-DA****71-A956-00-DA**Kit unión "I" ON-OFF  
Kit união "I" ON-OFF**71-A955-00-00****71-A956-00-00****71-A956-00-00****Accesorios de conexión**  
Acessórios de conexãoKit unión DALI  
Kit união DALI**71-8246-00-DA****71-8246-00-DA****71-8246-00-DA**

# Infinite Pro

## Infinite Pro Lens

IP
40

BODY MAT
AL

UGR
<10



50000h
L80 B20



Ejemplo de código / Exemplo de código: **AK14-2PW8R20S14**

Model	W	K / CRI / Real lm	Optics	Source	Finishes
<b>1136 mm</b>  <b>AK14 - Superficie Superficie</b>   <b>AK15 - Suspendida Suspensa</b>   <b>AK16 - Empotrada Encastrada</b> 0-25 mm 1140x65   <b>AK23 - Suspendida / Acústica Suspensa / Acústica</b> 	<b>2P</b> 17.9W	<b>W8</b> 3000K / CRI 80 / 2342 lm <b>W9</b> 3000K / CRI 90 / 2069 lm <b>X8</b> 4000K / CRI 80 / 2818 lm <b>X9</b> 4000K / CRI 90 / 2285 lm	<b>R2</b> Wall Washer  <b>B2</b> Batwing  <b>L9</b> Lens 90°  <b>E2</b> Elíptic 	<b>OS</b> ON-OFF 220-240V <b>OU</b> ON-OFF 100-277V <b>DS</b> DALI 220-240V <b>OS</b> ON-OFF 220-240V <b>OU</b> ON-OFF 100-277V <b>DS</b> DALI 220-240V	<b>14</b> <b>N3</b> <b>60</b> <b>GA</b> <b>GB</b>
	<b>34</b> 33.7W	<b>W8</b> 3000K / CRI 80 / 4285 lm <b>W9</b> 3000K / CRI 90 / 3826 lm <b>X8</b> 4000K / CRI 80 / 4559 lm <b>X9</b> 4000K / CRI 90 / 3513 lm	<b>NA</b> Track 	<b>BU</b>	
	<b>AA</b>	<b>CC</b>			



# Infinite Pro

## Infinite Pro Up&Down Lens

IP
40

BODY MAT
AL



3
MacAdam



Ejemplo de código / Exemplo de código: **AK24-2PWBR20S14**

Model	W	K / CRI / Real lm		Optics	Source	Finishes								
		↑UP	↓DOWN											
<p><b>AK24 -</b> Suspendida / Up&amp;Down Suspensa / Up&amp;Down</p> <p>○ ● ○ 14 60 N3</p> <p><b>1136 mm</b></p>	<b>2P</b> 26.5W↑ 17W↓W	<b>WB</b> 3000K / CRI 80 / 5877 lm	3000K / CRI 90 / 5877 lm	<b>R2</b> Wall Washer 	<b>OS</b> ON-OFF 220-240V	<b>14</b> ○ <b>N3</b> ● <b>60</b> ●								
							<b>XB</b> 4000K / CRI 80 / 6444 lm	4000K / CRI 90 / 6444 lm	<b>B2</b> Batwing 	<b>OU</b> ON-OFF 100-277V				
											<b>QB</b> 3000K / CRI 80 / 6204 lm	4000K / CRI 90 / 6204 lm	<b>L9</b> Lens 90° 	
	<b>34</b> 26.5W↑ 30.3W↓W	<b>WB</b> 3000K / CRI 80 / 7858 lm	3000K / CRI 90 / 7858 lm	<b>E2</b> Eliptic 	<b>OS</b> ON-OFF 220-240V									
							<b>XB</b> 4000K / CRI 80 / 7803 lm	4000K / CRI 90 / 7803 lm	<b>OU</b> ON-OFF 100-277V					
										<b>QB</b> 3000K / CRI 80 / 7545 lm	4000K / CRI 90 / 7545 lm	<b>DS</b> DALI 220-240V		
													<b>RB</b> 4000K / CRI 80 / 8116 lm	3000K / CRI 90 / 8116 lm
	<b>16</b> 26.5W↑ TRACK↓W	<b>WB</b> 3000K / CRI 80 / 4290 lm	TRACK	<b>NA</b> Track 	<b>OS</b> ON-OFF 220-240V									
							<b>XB</b> 4000K / CRI 80 / 4032 lm	TRACK	<b>OU</b> ON-OFF 100-277V					

Infinite Pro Lens  
1136mm SurfaceInfinite Pro  
Lens 1136mm  
SuspendedInfinite Pro  
Lens 1136mm  
Up&Down

### Accesorios de fijación requeridos

### Accesórios de fixação requeridos

	Florón suspendido con toma de corriente ON-OFF Florão suspenso com tomada de corrente ON-OFF	14 ○	-	<b>71-7520-14-00</b>	<b>71-7520-14-00</b>
		60 ●	-	-	<b>71-7520-60-00</b>
		N3 ○	-	-	<b>71-7520-N3-00</b>
	Florón suspendido con toma de corriente DALI Florão suspenso com tomada de corrente DALI	14 ○	-	<b>71-7521-14-00</b>	-
		60 ●	-	-	<b>71-7521-60-00</b>



### Accesorios de fijación

### Accesórios de fixação

	Accesorio para instalación en pared Accesório para instalação na parede	14 ○	<b>71-7518-14-00</b>	-	<b>71-7518-14-00</b>
		60 ●	-	-	<b>71-7518-60-00</b>
		N3 ○	<b>71-7518-N3-00</b>	-	<b>71-7518-N3-00</b>

### Accesorios de unión

### Accesórios de união

	Unión 90° ON-OFF União 90° ON-OFF	14 ○	<b>71-8113-14-00</b>	<b>71-8113-14-00</b>	-
		N3 ○	<b>71-8113-N3-00</b>	-	-
	Unión 90° DALI União 90° DALI		<b>71-8113-14-DA</b>	<b>71-8113-14-DA</b>	-
	Kit unión "I" ON-OFF Kit união "I" ON-OFF		<b>71-A955-00-00</b>	<b>71-A955-00-00</b>	<b>71-A956-00-00</b>
	Kit unión "I" DALI Kit união "I" DALI		<b>71-A955-00-DA</b>	<b>71-A955-00-DA</b>	<b>71-A956-00-DA</b>

### Accesorios de conexión

### Accesórios de conexão

	Kit unión DALI Kit união DALI		-	-	<b>71-8246-00-DA</b>
-------------------------------------------------------------------------------------	----------------------------------	--	---	---	----------------------

# Infinite Slim



+ Infinite Slim



## Miniaturización e iluminación integradora Miniaturização e a iluminação integradora

Los espacios de trabajo son cada vez más exigentes. Miniaturización e iluminación integradora son características fundamentales que se han convertido en tendencia para favorecer el ambiente de trabajo y el bienestar de las personas. Con un alto paquete lumínico y una óptica super extensiva en un cuerpo de sólo 25 mm de ancho, Infinite Slim es tendencia por sí misma.

Os espaços de trabalho estão a tornar-se cada vez mais exigentes. A miniaturização e a iluminação integradora são características fundamentais que se tornaram tendência em termos de ambiente de trabalho e do bem-estar das pessoas. Com um alto pacote lumínico e uma ótica superextensiva num corpo de apenas 25 mm de largura, Infinite Slim é por si só uma tendência.





## Adaptable al espacio Adaptável ao espaço

Con posibilidad de montaje en superficie o suspensión, Infinite Slim es la solución perfecta para adaptarse al concepto arquitectónico del espacio. Superfície montada ou suspensa, Infinite Slim é a solução perfeita para combinar com o conceito arquitectónico do espaço.



Superficie  
Superfície



Suspendida  
Suspensa

## Líneas continuas Linhas contínuas

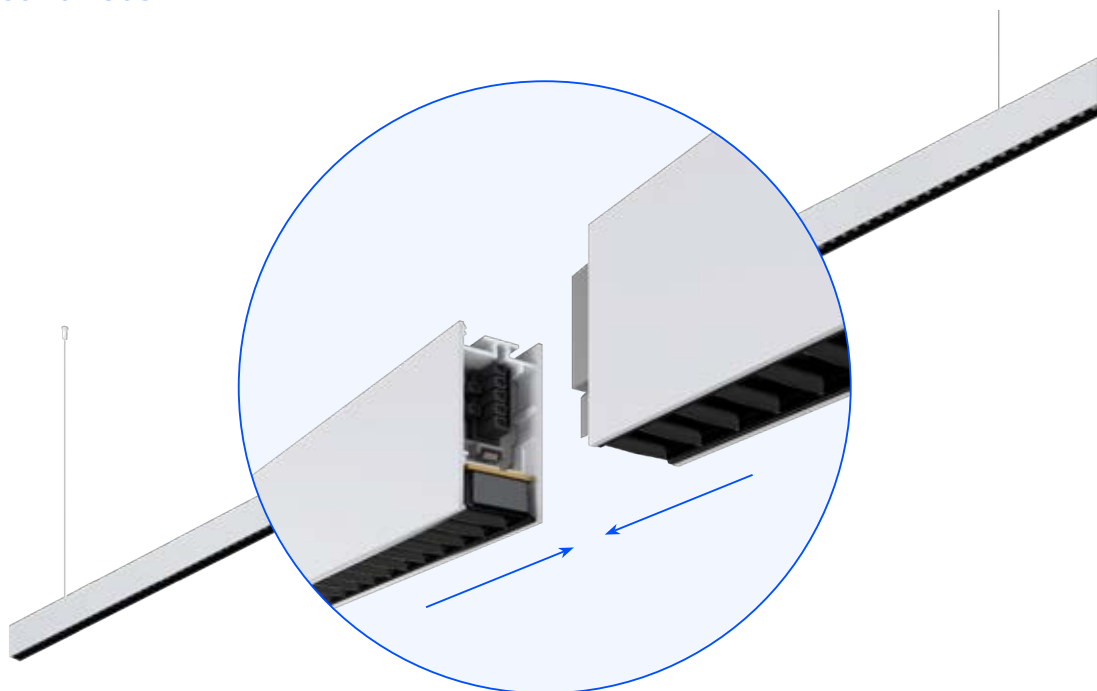

### Unión mecánica y eléctrica Click&Go União mecânica e elétrica Click&Go

El diseño de la unión mecánica y eléctrica "Click & Go" permite la creación de líneas continuas que se convierten en trazos lumínicos de altas prestaciones, garantizando la continuidad lumínica y de servicio de las luminarias.

A conceção da união mecânica e elétrica "Click & Go" permite a criação de linhas contínuas que se tornam traços lumínicos de alto desempenho, garantindo a continuidade lumínica e de serviço das luminárias.

Gran confort visual con una óptica  
extensiva de tan sólo 25mm  
Alto conforto visual com uma ótica  
extensiva de apenas 25 mm



# Infinite Slim

## Infinite Slim Individual

BODY MAT	DIF MAT		50000h	IP		UGR		
AL	PC		L80 B20	40		<19		

Ejemplo de código / Exemplo de código: **BB19-44W9GMOS14**

Model	W	K / CRI / Real lm	Optics	Source	Finishes
<b>BB19 -</b> Superficie   1680 mm	<b>44</b> 43.1W	<b>W9</b> 3000K / CRI 90 / 5221 lm	<b>GM</b> Plata Mate	<b>OS</b> ON-OFF 220-240V	<b>14</b> <b>60</b> <b>16</b>
		<b>X9</b> 4000K / CRI 90 / 4656 lm	<b>NM</b> Negro Mate	<b>DS</b> DALI-2 220-240V	
<b>BB21 -</b> Colgante   1680 mm					

## Infinite Slim Inicio

BODY MAT	DIF MAT		50000h	IP		UGR		
AL	PC		L80 B20	40		<19		

Ejemplo de código / Exemplo de código: **BB11-29W9GMOS14**

Model	W	K / CRI / Real lm	Optics	Source	Finishes
<b>BB11 -</b> Superficie   1120 mm	<b>29</b> 28.7W	<b>W9</b> 3000K / CRI 90 / 3481 lm	<b>GM</b> Plata Mate	<b>OS</b> ON-OFF 220-240V	<b>14</b> <b>60</b> <b>16</b>
		<b>X9</b> 4000K / CRI 90 / 3104 lm	<b>NM</b> Plata Mate  <b>NM</b> Negro Mate	<b>DS</b> DALI-2 220-240V	
<b>BB12 -</b> Colgante   1120 mm					



BODY MAT
AL

DIF MAT
PC



50000h
L80 B20











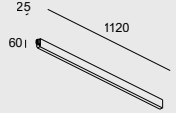

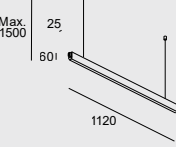







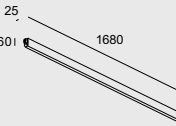

IP
40

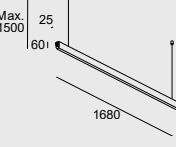

UGR
<19

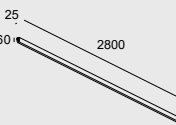
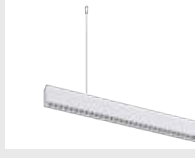
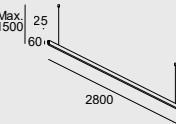

Ejemplo de código / Exemplo de código: **BB13-29W9GMOS14**

Model	W	K / CRI / Real lm	Optics	Source	Finishes
<b>1120 mm</b> <b>BB13 -</b> Superficie   <b>BB14 -</b> Colgante  	<b>29</b> 28.7W	<b>W9</b> 3000K / CRI 90 / 3481 lm	<b>GM</b> Plata Mate	<b>OS</b>  ON-OFF 220-240V	<b>14</b>  <b>60</b>  <b>16</b> 
		<b>X9</b> 4000K / CRI 90 / 3104 lm	<b>NM</b> Negro Mate	<b>DS</b>  DALI-2 220-240V	
	<b>44</b> 43.1W	<b>W9</b> 3000K / CRI 90 / 5221 lm	<b>GM</b> Plata Mate	<b>OS</b>  ON-OFF 220-240V	
		<b>X9</b> 4000K / CRI 90 / 4656 lm	<b>NM</b> Negro Mate	<b>DS</b>  DALI-2 220-240V	
	<b>73</b> 71.4W	<b>W9</b> 3000K / CRI 90 / 8702 lm	<b>GM</b> Plata Mate	<b>OS</b>  ON-OFF 220-240V	
		<b>X9</b> 4000K / CRI 90 / 7760 lm	<b>NM</b> Negro Mate	<b>DS</b>  DALI-2 220-240V	
<b>1680 mm</b> <b>BB15 -</b> Superficie   <b>BB16 -</b> Colgante  	<b>14</b>  <b>60</b>  <b>16</b> 				
<b>2800 mm</b> <b>BB17 -</b> Superficie   <b>BB18 -</b> Colgante  	<b>14</b>  <b>60</b>  <b>16</b> 				

# Lineal

BODY MAT	DIF MAT
AL	PC

Lineal es una colección de perfiles que se adaptan a todas las necesidades con distintas formas de instalación para encajar en superficies de diversas índoles. Lineal es una colección de perfiles que se adaptan a todas las necesidades con distintas formas de instalación para encajar en superficies de diversas índoles.

Lineal é uma coleção de perfis que se adaptam a todas as necessidades com diferentes formas de instalação para se encaixar em superfícies de vários tipos



## Lineal Surfaced A

IP
20

○  
54

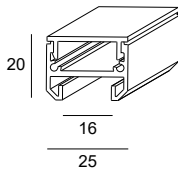

mm

2006

Code

71-3454 - 54 - M2  
M3

## Lineal Surfaced C

○  
54

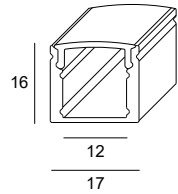

mm

2000

Code

71-A296 - 54 - M3

## Lineal Square

○  
54

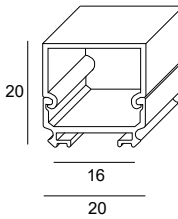

mm

2000

Code

71-8129 - 54 - M3

### Lineal Surfaced A

### Lineal Surfaced C

### Lineal Square



## Accesorios de fijación Acessórios de fixação



3 clips  
3 fastening clips

Included

-

-

4 clips  
4 fastening clips

-

Included

Included



2 tapas finales  
2 end caps

Included

-

-

4 tapas finales  
4 end caps

-

Included

Included

## Lineal Flat Rectangular

54

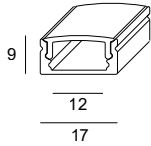

mm  
2000

Code  
71-8130 - 54 - M3

## Lineal Square Tiny

54

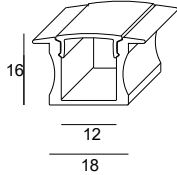

mm  
2000

Code  
71-8131 - 54 - M3

## Lineal Surfaced Corner

54

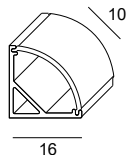

mm  
2000

Code  
71-8132 - 54 - M3

### Lineal Flat Rectangular



### Lineal Square Tiny



### Lineal Surfaced Corner



## Accesorios de fijación Acessórios de fixação



3 clips  
3 fastening clips

-

-

-

4 clips  
4 fastening clips

Included

Included

Included



2 tapas finales  
2 end caps

-

-

-

4 tapas finales  
4 end caps

Included

Included

Included

# Taglio di Luce

Designed by LedsC4 Architectural



+ Taglio di Luce



La colección Taglio di Luce nos abre las puertas a una iluminación integrada donde la luz se funde en el espacio ofreciendo la posibilidad a arquitectos y diseñadores de crear composiciones lineales, con efectos en paredes y techos. La estructura está fabricada en aluminio y acabada en pintura blanca en polvo.

A coleção Taglio di Luce abre-nos as portas para uma iluminação integrada onde a luz se funde com o espaço, oferecendo aos arquitetos e designers a possibilidade de criar composições lineares, com efeitos nas paredes e tetos. A estrutura é fabricada em alumínio e acabamento em tinta branca em pó.





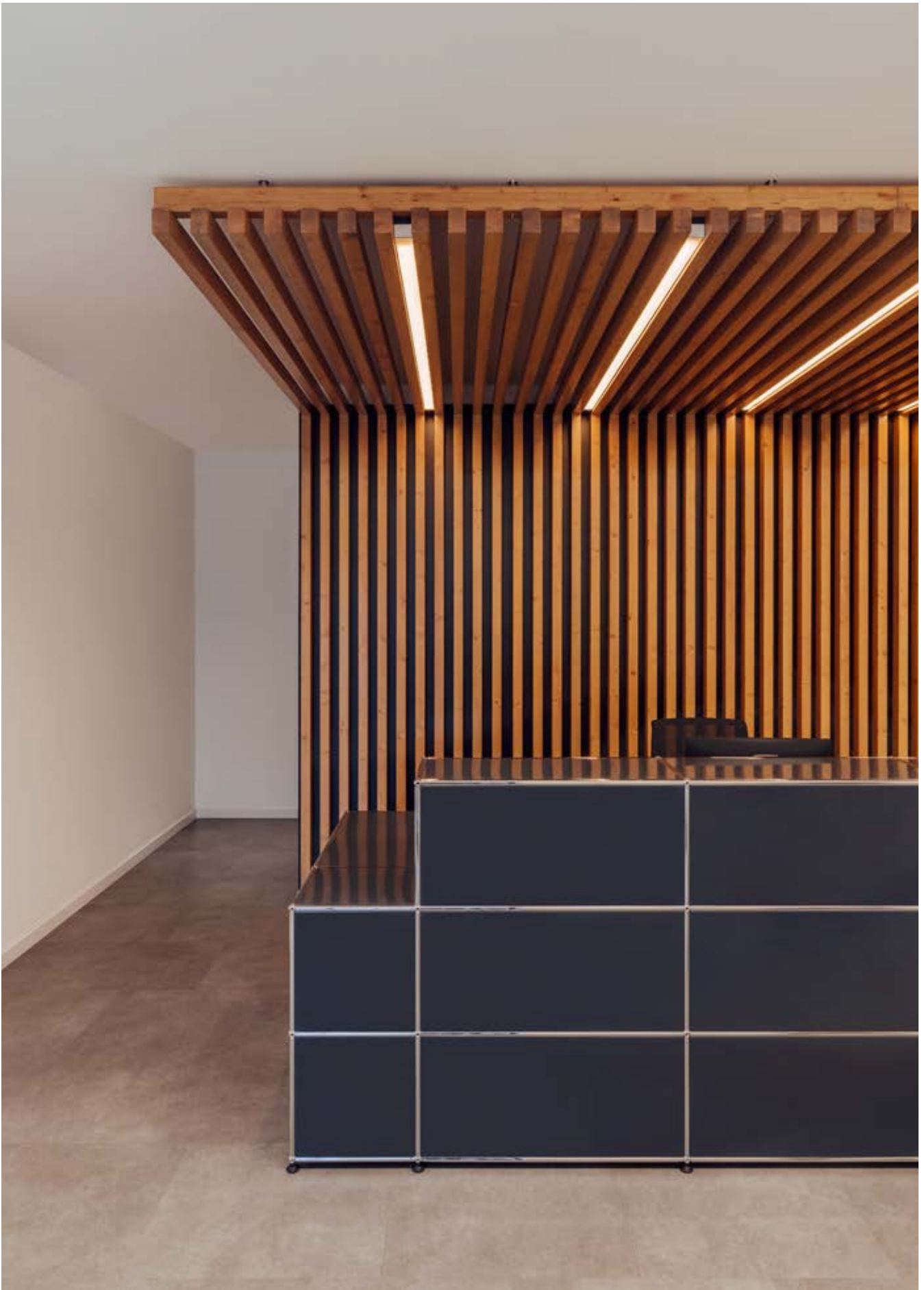

**Taglio di luce direct de superficie.** Integración en la arquitectura para enfatizar el espacio con un juego de luz lineal. Proyecto Manusa.  
**Taglio di luce direct de superficie.** Integração na arquitetura para enfatizar o espaço com um jogo de luz linear. Projeto Manusa.









Las estructuras de Taglio di luce pueden combinarse con tiras Led de la colección ON que ofrece múltiples opciones, como RGB.  
As estruturas de Taglio di luce podem ser combinadas com fitas LED da coleção ON que oferece múltiplas opções, como RGB.  
Ver colección ON / Ver coleção ON



## Surface

Ideal para estructuras de madera y techos de hormigón con difícil empotramiento.

Ideal para estruturas de madeira e tetos de betão com difícil encastramento.



## Recessed Trim

Fácil instalación gracias al diseño de las aletas, que permiten salvar pequeñas irregularidades.

Instalação fácil graças ao design das aletas, que permitem que pequenas irregularidades sejam salvas.

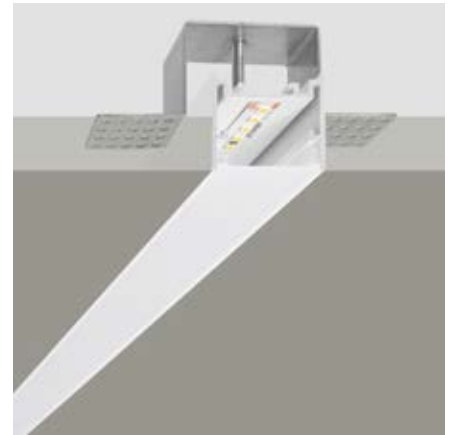

## Recessed Trimless

Integración total en el espacio, donde la única protagonista es la luz.

Integração total no espaço, onde a única protagonista é a luz.

### Trim

### Trimless

66 mm



50 mm



66 mm



35 mm



49 mm



19 mm



### Taglio Di Luce Direct 19 mm Trim

○  
14

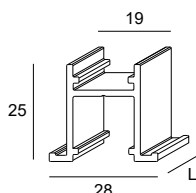

mm	Code
1000	71-5738
2000	71-5739 - 14 - 00
3000	71-5740

20xL 0-20 mm

### Taglio Di Luce Direct 19 mm Trimless

○  
14

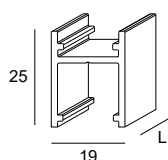

mm	Code
1000	71-5741
2000	71-5742 - 14 - 00
3000	71-5743

19xL 0-15 mm

### Taglio Di Luce Direct 35 mm Trim

○  
14

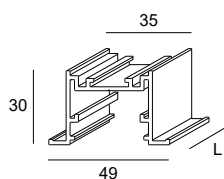

mm	Code
1000	71-5744
2000	71-5745 - 14 - 00
3000	71-5746

40xL 0-25 mm

### Taglio Di Luce Direct 35 mm Trimless

○  
14

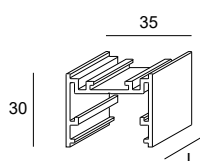

mm	Code
1000	71-5747
2000	71-5748 - 14 - 00
3000	71-5749

35xL 0-20 mm

### Taglio Di Luce Direct 50 mm Trim

○  
14

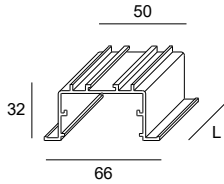

**mm**

1000  
2000  
3000

**Code**

**71-8082**  
**71-8083 - 14 - 00**  
**71-8084**

⌀ 55 0-25 mm

### Taglio Di Luce Direct 50 mm Trimless

○  
14

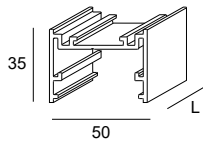

**mm**

1000  
2000  
3000

**Code**

**71-5753**  
**71-5754 - 14 - 00**  
**71-5755**

50xL 0-25 mm

### Esquema de Instalación / Esquema de instalação

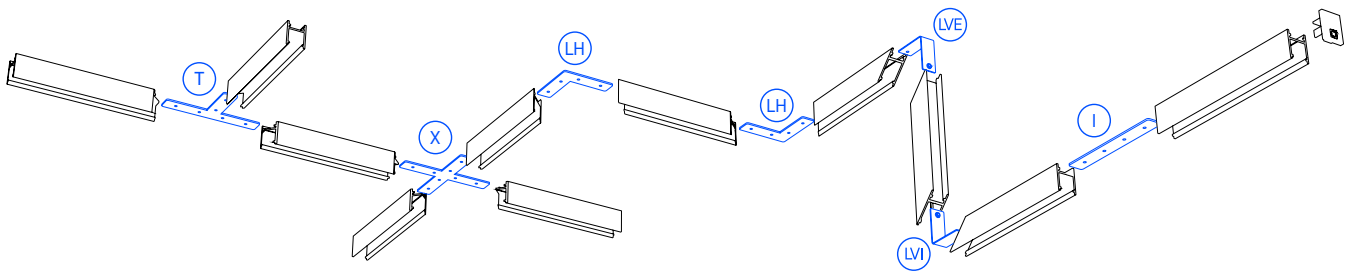

### Accesorios de unión / Acessórios de união



Ⓣ

**Kit unión T**  
Kit união T

**71-5784-00-00**  
**00,00€**



ⓧ

**Kit unión X**  
Kit união X

**71-5785-00-00**



ⓁH

**Kit unión LH**  
Kit união LH

**71-5783-00-00**



ⓁVE

**Kit unión LVE**  
Kit união LVE

**71-5757-00-00**



ⓁVI

**Kit unión LVI**  
Kit união LVI

**71-5758-00-00**







Ⓛ



**Kit unión I**  
Kit união I

**71-5782-00-00**





Taglio Di Luce  
Direct 19 mm TrimTaglio Di Luce  
Direct 19 mm  
TrimlessTaglio Di Luce  
Direct 35 mm Trim**Accesorios ópticos requeridos**  
**Accessori ottici richiesti**

	Difusor 1000mm Difusor 1000mm	71-5771-00-00	71-5771-00-00	71-5775-00-00
	Difusor 2000mm Difusor 2000mm	71-5772-00-00	71-5772-00-00	71-5776-00-00
	Difusor 3000mm Difusor 3000mm	71-5773-00-00	71-5773-00-00	71-5777-00-00
	Difusor 10000mm Difusor 10000mm	71-5774-00-00	71-5774-00-00	71-5778-00-00

**Accesorios de fijación requeridos**  
**Acessórios de fixação requeridos**

	Kit de instalación 1000mm Kit de instalação 1000mm	71-5511-00-00	71-5786-00-00	71-5511-00-00
	Tapa final (2u.) Tampa final (2u.)	71-5765-14-00	71-5766-14-00	71-5767-14-00

**Accesorios de unión**  
**Acessórios de união**

	Kit unión "I" Kit união "I"	71-5782-00-00	71-5782-00-00	71-5782-00-00
	Kit unión "T" Kit união "T"	71-5784-00-00	71-5784-00-00	71-5784-00-00
	Kit unión "X" Kit união "X"	71-5785-00-00	71-5785-00-00	71-5785-00-00
	Kit unión "LH" Kit união "LH"	71-5783-00-00	71-5783-00-00	71-5783-00-00
	Kit unión "LVE" Kit união "LVE"	71-5757-00-00	71-5757-00-00	71-5757-00-00
	Kit unión "LVI" Kit união "LVI"	71-5758-00-00	71-5758-00-00	71-5758-00-00

Taglio Di Luce  
Direct 35 mm  
Trimless







Taglio Di Luce  
Direct 50 mm Trim





Taglio Di Luce  
Direct 50 mm  
Trimless









### Accesorios ópticos requeridos Accessori ottici richiesti

	Difusor 1000mm Difusor 1000mm	71-5775-00-00	71-5779-00-00	71-5779-00-00
	Difusor 2000mm Difusor 2000mm	71-5776-00-00	71-5780-00-00	71-5780-00-00
	Difusor 3000mm Difusor 3000mm	71-5777-00-00	71-5781-00-00	71-5781-00-00
	Difusor 10000mm Difusor 10000mm	71-5778-00-00	71-5486-00-00	71-5486-00-00

### Accesorios de fijación requeridos Acessórios de fixação requeridos

	Kit de instalación 1000mm Kit de instalação 1000mm	71-5787-00-00	71-5511-00-00	71-5788-00-00
	Tapa final (2u.) Tampa final (2u.)	71-5768-14-00	71-7640-14-00	71-5770-14-00

### Accesorios de unión Acessórios de união

	Kit unión "L" Kit união "L"	71-5782-00-00	71-5782-00-00	71-5782-00-00
	Kit unión "T" Kit união "T"	71-5784-00-00	71-5784-00-00	71-5784-00-00
	Kit unión "X" Kit união "X"	71-5785-00-00	71-5785-00-00	71-5785-00-00
	Kit unión "LH" Kit união "LH"	71-5783-00-00	71-5783-00-00	71-5783-00-00
	Kit unión "LVE" Kit união "LVE"	71-5757-00-00	71-5757-00-00	71-5757-00-00
	Kit unión "LVI" Kit união "LVI"	71-5758-00-00	71-5758-00-00	71-5758-00-00

# Taglio Di Luce Indirect

BODY MAT

AL

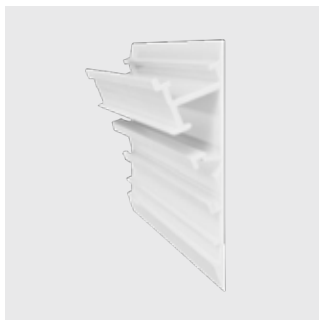

## Surface

Máxima integración, ya que su perfil puede ser pintado con el acabado final de la instalación.  
Integração máxima, já que o seu perfil pode ser pintado com o acabamento final da instalação.

## Recessed

La luminaria queda totalmente escondida e integrada en el techo, ideal para perímetros con foseado.  
A luminária fica completamente escondida e integrada no teto, ideal para perímetros com fosco.

### Taglio Di Luce Indirect Surface

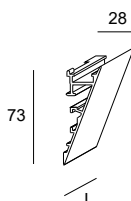

mm

1000  
2000  
3000

Code



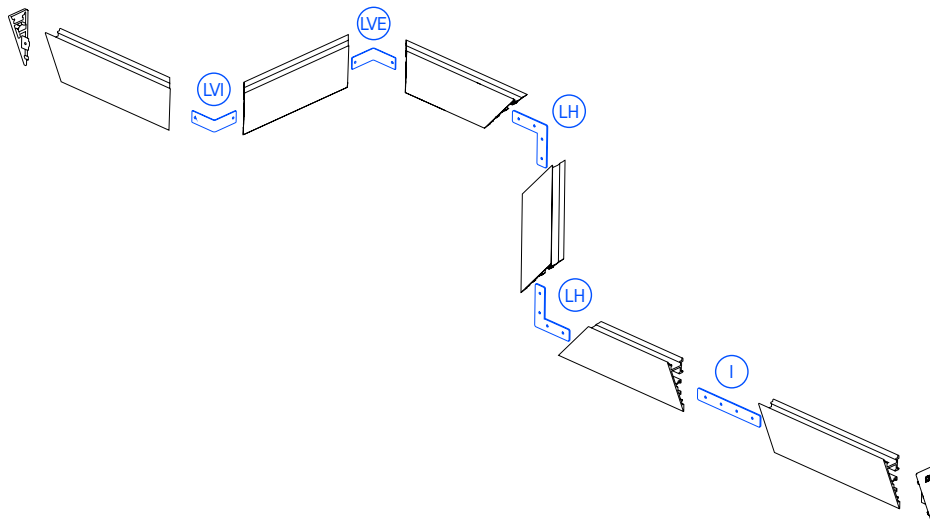

**71-5759**  
**71-5760 - 14 - 00**  
**71-5761**

○  
14





Accesorios de unión / Acessórios de união

			
<b>LVI</b> <b>Kit unión "LVI"</b> Kit união "LVI"	<b>LVE</b> <b>Kit unión "LVE"</b> Kit união "LVE"	<b>LH</b> <b>Kit unión "LH"</b> Kit união "LH"	<b>I</b> <b>Kit unión "I"</b> Kit união "I"
<b>71-5758-00-00</b>	<b>71-5757-00-00</b>	<b>71-5783-00-00</b>	<b>71-5782-00-00</b>

**Taglio Di Luce Indirect  
Recessed**

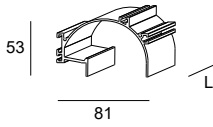

**mm**  
1000  
2000  
3000

**Code**  
**71-5762**  
**71-5763 - 14 - 00**  
**71-5764**

55xL 0-12 mm

**Esquema de Instalación / Esquema de instalação**

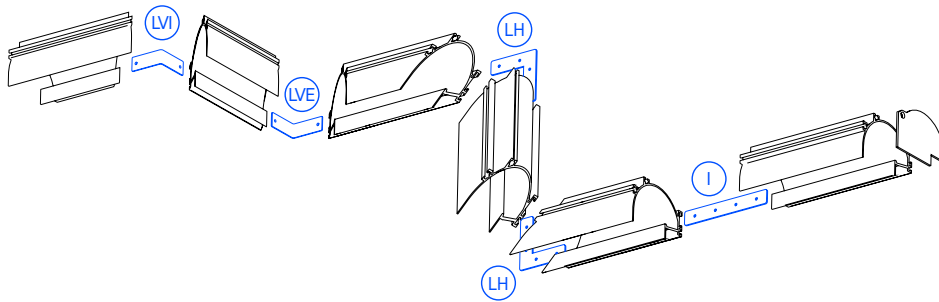

**Accesorios de unión / Acessórios de união**



**LVI**  
**Kit unión "LVI"**  
**Kit união "LVI"**

**71-5758-00-00**



**LVE**  
**Kit unión "LVE"**  
**Kit união "LVE"**

**71-5757-00-00**

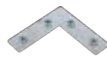

**LH**  
**Kit unión "LH"**  
**Kit união "LH"**

**71-5783-00-00**



**I**  
**Kit unión "I"**  
**Kit união "I"**

**71-5782-00-00**

Taglio Di Luce Indirect  
Surface







Taglio Di Luce Indirect  
Recessed





INDOOR



**Accesorios ópticos requeridos**  
**Accessori ottici richiesti**

	Difusor 1000mm Difusor 1000mm	<b>71-5771-00-00</b>	-
	Difusor 2000mm Difusor 2000mm	<b>71-5772-00-00</b>	-
	Difusor 3000mm Difusor 3000mm	<b>71-5773-00-00</b>	-
	Difusor 10000mm Difusor 10000mm	<b>71-5774-00-00</b>	-

**Accesorios de fijación requeridos**  
**Accessórios de fixação requeridos**

	Kit de instalación 1000mm Kit de instalação 1000mm	-	<b>71-5789-00-00</b>
	Tapa final (2u.) Tampa final (2u.)	<b>71-5608-14-00</b>	<b>71-5609-14-00</b>
	Kit instalación perfil Kit de instalação perfil	<b>71-5756-14-00</b>	-

**Accesorios de unión**  
**Accessórios de união**

	Kit unión "I" Kit união "I"	<b>71-5782-00-00</b>	<b>71-5782-00-00</b>
	Kit unión "LH" Kit união "LH"	<b>71-5783-00-00</b>	<b>71-5783-00-00</b>
	Kit unión "LVE" Kit união "LVE"	<b>71-5757-00-00</b>	<b>71-5757-00-00</b>
	Kit unión "LVI" Kit união "LVI"	<b>71-5758-00-00</b>	<b>71-5758-00-00</b>

SISTEMAS LINEALES | SISTEMAS LINEARES

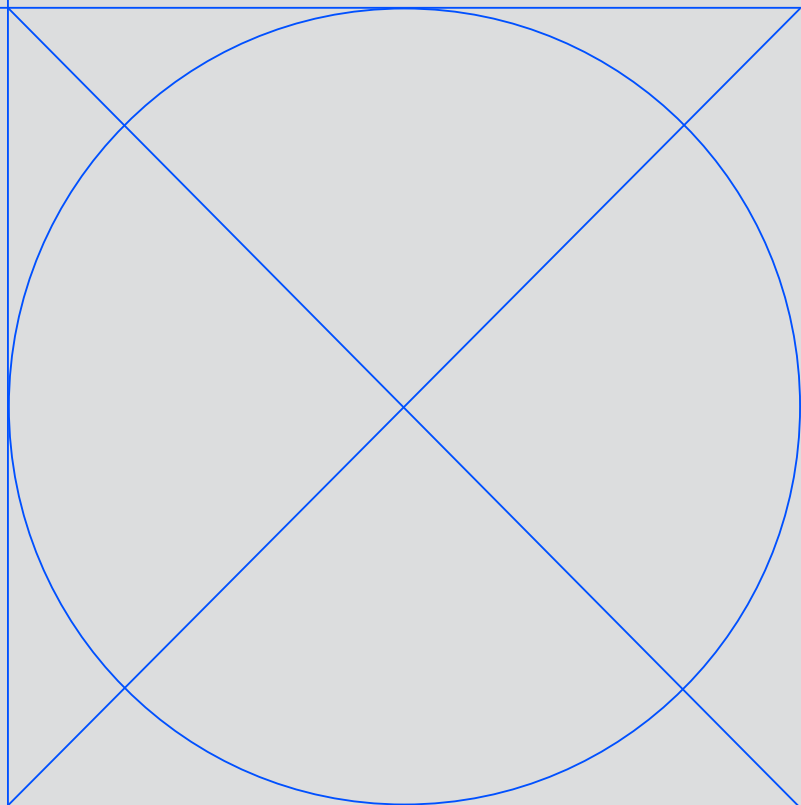

Tiras LED  
Fitas LED

Asai 3D

426

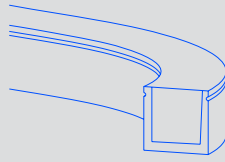

On

434

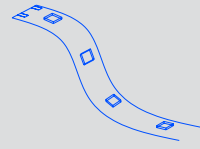

# Asai 3D



+ Asai 3D



Asai 3D se adapta con facilidad a cualquier contorno y ambiente, creando efectos continuos e infinitos. Posee una extraordinaria flexibilidad y resistencia, gracias al cuerpo extrusionado fabricado en poliuretano. Asai 3D adapta-se facilmente a qualquer contorno e ambiente, criando efeitos contínuos e infinitos. Possui uma extraordinária flexibilidade e resistência, graças ao corpo extrudido feito de poliuretano.



Flexibilidad 3D  
Flexibilidade 3D

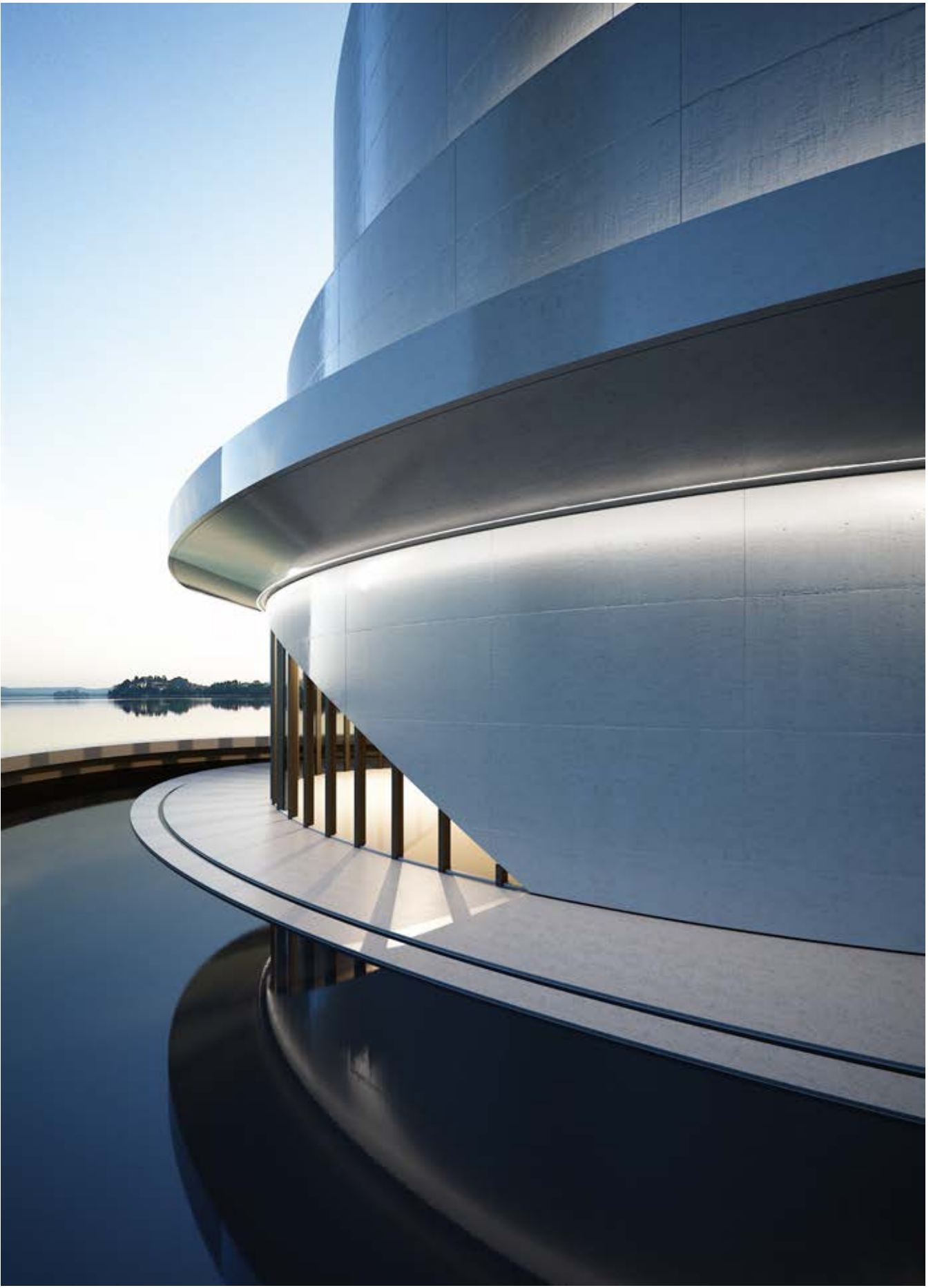

IP65. IK10. Apta para exteriores con impacto medioambiental sobre la luminaria  
IP65. IK10. Adequado para exteriores com impacto proteção ambiental na luminária



Asai 3D permite curvas infinitas  
gracias a su flexibilidad  
Asai 3D permite curvas infinitas  
graças à sua flexibilidade





Adaptación a todo tipo de superficie gracias a su flexibilidad 3D y la facilidad de corte

Adapta-se a todo o tipo de superficie graças à sua flexibilidade 3D e facilidade de corte

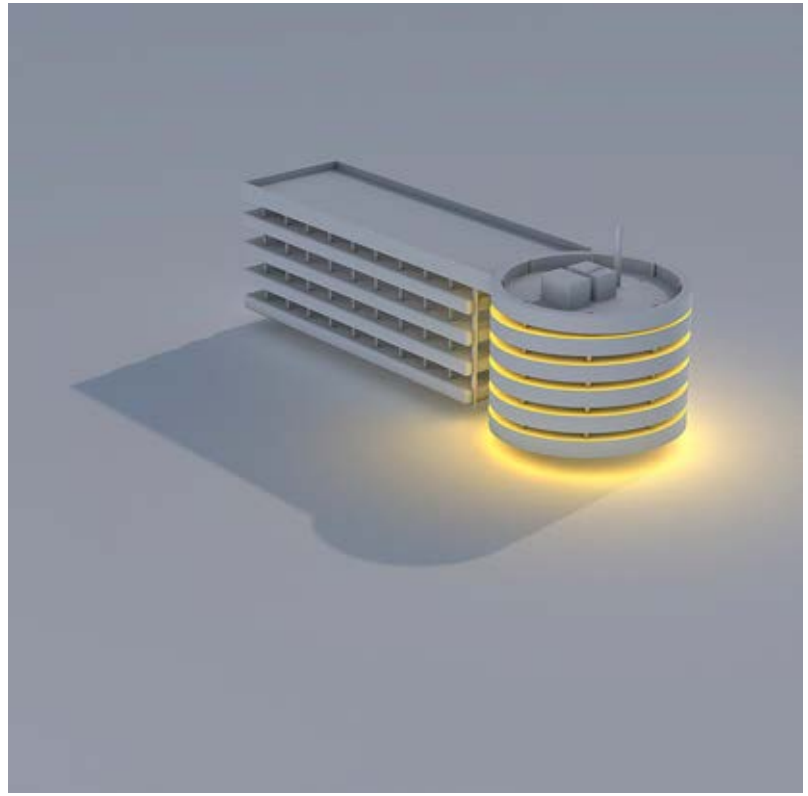

Disponible en medidas de 1 y 8 m., se pueden cortar cada 10 cm. para ajustarse a la longitud del espacio a iluminar.

Disponível nas medidas de 1 e 8 m, podem ser cortados a cada 10 cm para se ajustarem ao comprimento do espaço a ser iluminado.

Conectores IP68 para una conexión rápida

Conectores IP68 para uma conexão rápida





Proyecto Novotel. Madagascar, 2022.  
Proyecto Novotel. Madagascar, 2022.

# Asai 3D

BODY MAT
PVC

DIF MAT
PVC



50000h
L80 B20

5
MacAdam

## Asai 3D 1000mm

IP
67

IK
10

8 m
-----

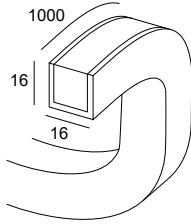

LED						24VDC
K	CRI	W	Real Lm	mm	Code	
3000	80	14.4	441	1000	<b>91-A000 - 00 - 00</b>	
4000	80	14.4	498	1000	<b>91-A002 - 00 - 00</b>	
RGB		14.4	194	1000	<b>91-A004 - 00 - 00</b>	

## Asai 3D 8000mm

IP
67

IK
10

8 m
-----

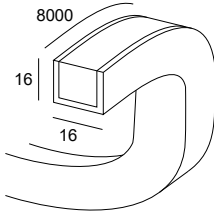

LED						24VDC
K	CRI	W	Real Lm	mm	Code	
3000	80	115.2	3529	8000	<b>91-A001 - 00 - 00</b>	
4000	80	115.2	3988	8000	<b>91-A003 - 00 - 00</b>	
RGB		115.2	1552	8000	<b>91-A005 - 00 - 00</b>	

Asai 3D 1000mm

Asai 3D 1000mm  
RGB

Asai 3D 8000mm

Asai 3D 8000mm  
RGB**Fuentes de alimentación**  
Fontes de alimentação

P. 1166

CASAMBI  
IP67**71-A242-00-00**

-

**71-A242-00-00**

-

**Controladores**  
Controladores

P. 1166

CASAMBI  
IP20

-

**71-8050-00-00**

-

**71-8050-00-00****Accesorios de fijación**  
Acessórios de fixaçãoClips (20u.)  
Clipes (20u.)**71-6607-00-00****71-6607-00-00****71-6607-00-00****71-6607-00-00**Perfil 2m flexible  
Perfil 2m flexível**71-7698-00-00****71-7698-00-00****71-7698-00-00****71-7698-00-00**Perfil 2m rígido  
Perfil 2m rígido**71-6608-00-00****71-6608-00-00****71-6608-00-00****71-6608-00-00****Accesorios de conexión**  
Acessórios de conexãoCable con conectores estancos  
macho-hembra (1m)  
Cabo com conetores estanques  
macho-fêmea (1 m)**71-E034-00-00**

-

**71-E034-00-00**

-

Cable con conectores estancos  
macho-hembra (5m)  
Cabo com conetores estanques  
macho-fêmea (5 m)**71-E004-00-00**

-

**71-E004-00-00**

-

Cable RGB con conectores  
estancos macho-hembra (1m)  
Cabo RGB com conetores  
estanques macho-fêmea (1 m)

-

**71-E071-00-00**

-

**71-E071-00-00**Cable RGB con conectores  
estancos macho-hembra (5m)  
Cabo RGB com conetores  
estanques macho-fêmea (5 m)

-

**71-E005-00-00**

-

**71-E005-00-00**

# On



+ On



Colección de tiras flexibles con una amplia gama de potencias y opciones que permiten conseguir cualquier efecto y potenciar los ambientes con una iluminación sutil desde un contorno que pasa desapercibido, ajustándose a formas y estructuras.

Coleção de fitas flexíveis com uma ampla gama de potências e opções que permitem conseguir qualquer efeito e potenciar os ambientes com uma iluminação subtil a partir de um contorno que passa despercebido, ajustando-se às formas e estruturas.





On basic en proyecto retail. Pilma Madrid. Fotografía: Javier Marquez.  
On basic em projeto retail. Pilma Madrid. Fotografía: Javier Marquez.

Opción de controlar el haz de luz gracias a los accesorios disponibles  
Opção para controlar o feixe de luz graças a acessórios disponíveis



## Funcionalidad Smart Funcionalidade Smart

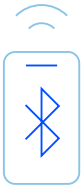

Posibilidad de generar escenas lumínicas para adaptarse a las necesidades de comunicación y concepto del espacio.

Possibilidade de gerar cenas lumínicas para se adaptar às necessidades de comunicação e ao conceito do espaço.



INDOOR



Opciones IP65 aptas para el exterior  
Opções IP65 adequadas para o exterior

TIRAS LED | FITAS LED



# On Basic 4,8



50000h
L80 B20

3
MacAdam

## On Basic 4,8

IP
20

••• + •••
10 m

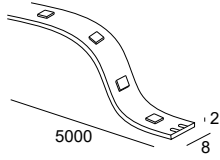

LED						24VDC
K	CRI	W	Real Lm	mm	Code	
2700	80	24	2428	5000	<b>91-7908 - 00 - 00</b>	
3000	80	24	2524	5000	<b>91-7909 - 00 - 00</b>	
4000	80	24	2621	5000	<b>91-7910 - 00 - 00</b>	
6000	80	24	2725	5000	<b>91-7911 - 00 - 00</b>	

## On Basic 4,8 RGB

IP
20

RGB LIGHT
--------------

••• + •••
10 m

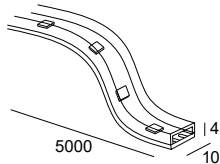

LED					24VDC
K	W	Real Lm	mm	Code	
RGB	24	1402	5000	<b>91-A012 - 00 - 00</b>	

## On Basic 4,8 IP65



IP
65

BREEAM
--------

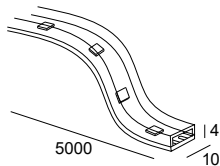
••• + •••
8 m



LED						24VDC
K	CRI	W	Real Lm	mm	Code	
2700	80	24	1820	5000	<b>91-7912 - 00 - 00</b>	
3000	80	24	1890	5000	<b>91-7913 - 00 - 00</b>	
4000	80	24	1965	5000	<b>91-7914 - 00 - 00</b>	
6000	80	24	2047	5000	<b>91-7915 - 00 - 00</b>	

	On Basic 4,8	On Basic 4,8 RGB	On Basic 4,8 IP65
			



### Controladores

P. 1166

 CASAMBI IP67	71-A242-00-00	71-A242-00-00	71-A242-00-00
---------------------------------------------------------------------------------------------------	---------------	---------------	---------------



### Accesorios de unión

#### Accessórios de união

 Unión (5u.) União (5u.)	71-8093-00-00	-	71-8095-00-00
 Unión RGB (5u.) União RGB (5u.)	-	71-8097-00-00	-

### Accesorios de conexión

#### Accessórios de conexão

 Conector de inicio 2 cables (5u.) Conetor de início 2 cabos (5u.)	71-8092-00-00	-	71-8094-00-00
 Conector de inicio 4 cables (5u.) Conetor de início 4 cabos (5u.)	-	71-8096-00-00	-

# On Basic 9,6



50000h
L80 B20

3
MacAdam

## On Basic 9,6

IP
20

••• + •••
8 m

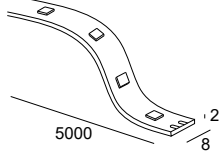

LED						24VDC
K	CRI	W	Real Lm	mm	Code	
2500	80	48	4100	5000	<b>91-3282</b>	- 00 - 00
2700	80	48	4916	5000	<b>91-7916</b>	- 00 - 00
3000	80	48	5113	5000	<b>91-7917</b>	- 00 - 00
4000	80	48	5309	5000	<b>91-7918</b>	- 00 - 00
6000	80	48	5520	5000	<b>91-7919</b>	- 00 - 00

## On Basic 9,6 RGB

IP
20

RGB LIGHT
-----------

••• + •••
6 m

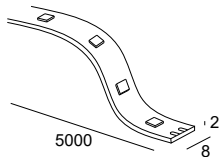

LED					24VDC
K	W	Real Lm	mm	Code	
RGB	48	1530	5000	<b>91-7920</b>	- 00 - 00

## On Basic 9,6 IP65

IP
65

BREEAM
--------

••• + •••
6 m

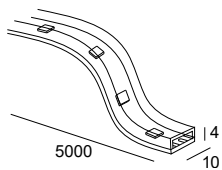

LED						24VDC
K	CRI	W	Real Lm	mm	Code	
2700	80	48	3526	5000	<b>91-7921</b>	- 00 - 00
3000	80	48	4228	5000	<b>91-7922</b>	- 00 - 00
4000	80	48	4397	5000	<b>91-7923</b>	- 00 - 00
6000	80	48	4566	5000	<b>91-7924</b>	- 00 - 00

## On Basic 9,6 IP65 RGB



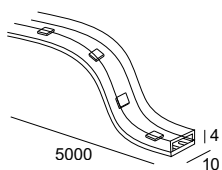

IP
65

RGB LIGHT
-----------

••• + •••
6 m





LED					24VDC
K	W	Real Lm	mm	Code	
RGB	48	1468	5000	<b>91-7925</b>	- 00 - 00



	On Basic 9,6	On Basic 9,6 RGB	On Basic 9,6 IP65	On Basic 9,6 IP65 RGB
				

**Controladores**  
Controladores



P. 1166

	CASAMBI IP20	-	<b>71-8050-00-00</b>	-	<b>71-8050-00-00</b>
	CASAMBI IP67	<b>71-A242-00-00</b>	-	<b>71-A242-00-00</b>	-

**Accesorios de unión**  
Acessórios de união

	Unión (5u.) União (5u.)	<b>71-8093-00-00</b>	-	<b>71-8095-00-00</b>	-
	Unión RGB (5u.) União RGB (5u.)	-	<b>71-8097-00-00</b>	-	<b>71-8099-00-00</b>

**Accesorios de conexión**  
Acessórios de conexão

	Conector de inicio 2 cables (5u.) Conetor de início 2 cabos (5u.)	<b>71-8092-00-00</b>	-	<b>71-8094-00-00</b>	-
	Conector de inicio 4 cables (5u.) Conetor de início 4 cabos (5u.)	-	<b>71-8096-00-00</b>	-	<b>71-8098-00-00</b>



# On Basic 14,4



50000h
L80 B20

3
MacAdam

## On Basic 14,4

IP
20

••• + •••
7 m

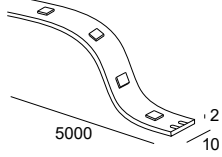

LED						24VDC
K	CRI	W	Real Lm	mm	Code	
2700	80	72	10687	5000	<b>91-7926</b>	- 00 - 00
3000	80	72	11023	5000	<b>91-7927</b>	- 00 - 00

## On Basic 14,4 RGB

IP
20

RGB LIGHT
--------------

••• + •••
6 m

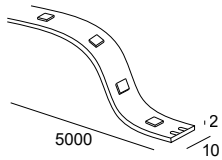

LED					24VDC
K	W	Real Lm	mm	Code	
RGB	72	2230	5000	<b>91-2379</b>	- 00 - 00

## On Basic 14,4 IP65

IP
65

••• + •••
5 m

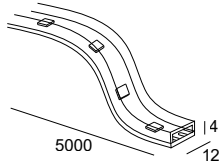

LED						24VDC
K	CRI	W	Real Lm	mm	Code	
3000	80	72	9879	5000	<b>91-A013</b>	- 00 - 00

On Basic 14,4

On Basic 14,4 RGB

On Basic 14,4 IP65



**Controladores**  
Controladores

P. 1166



CASAMBI  
IP20

-

**71-8050-00-00**

-



CASAMBI  
IP67

**71-A242-00-00**

-

**71-A242-00-00**

**Accesorios de unión**  
Acessórios de união



Unión (5u.) IP20  
União (5u.) IP20

**71-B422-00-00**

-

-



Conector de inicio 2 cables (5u.)  
Conetor de início 2 cabos (5u.)

**71-B421-00-00**

-

**71-B423-00-00**



Unión (5u.) IP65  
União (5u.) IP65

-

-

**71-B424-00-00**

# On Basic 19,2



50000h
L80 B20

3
MacAdam

## On Basic 19,2

IP
20

5 m
-----

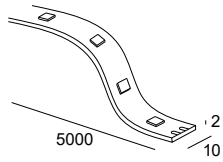

LED						24VDC
K	CRI	W	Real Lm	mm	Code	
2700	80	96	13073	5000	<b>91-7928</b>	- 00 - 00
3000	80	96	13521	5000	<b>91-7929</b>	- 00 - 00
4000	80	96	13819	5000	<b>91-A014</b>	- 00 - 00
6000	80	96	14038	5000	<b>91-A015</b>	- 00 - 00

## On Basic 19,2 IP65

IP
65

5 m
-----

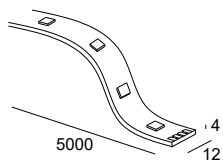

LED						24VDC
K	CRI	W	Real Lm	mm	Code	
2700	80	96	11845	5000	<b>91-A016</b>	- 00 - 00
3000	80	96	12054	5000	<b>91-5567</b>	- 00 - 00

On Basic 19,2  
2700K/3000K



On Basic 19,2  
4000K/6000K



On Basic 19,2 IP65



### Controladores Controladores

P. 1166



CASAMBI  
IP67

71-A242-00-00

71-A242-00-00

71-A242-00-00

### Accesorios de unión Acessórios de união



Unión (5u.)  
União (5u.)

71-B450-00-00

71-B450-00-00

71-B452-00-00



Conector de inicio 2 cables (5u.)  
Conetor de início 2 cabos (5u.)

71-B449-00-00

71-B451-00-00

71-B451-00-00



50000h  
L80 B20

3  
MacAdam

## On Basic 28,8

IP  
20

5 m

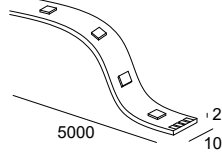

LED						24VDC	
K	CRI	W	Real Lm	mm	Code		
2700	80	144	13950	5000	<b>91-5571</b>	- 00	- 00
3000	80	144	14508	5000	<b>91-5572</b>	- 00	- 00
4000	80	144	15635	5000	<b>91-5573</b>	- 00	- 00

## Controladores Controladores

P. 1166



CASAMBI  
IP67

**71-A242-00-00**

## Accesorios de unión Acessórios de união



Conector de inicio 2 cables (5u.)  
Conetor de inicio 2 cabos (5u.)

**71-B421-00-00**



Unión (5u.) IP20  
União (5u.) IP20

**71-B422-00-00**

# On Performance 9,6



50000h
L80 B20

3
MacAdam

## On Performance 9,6

IP
20

••• + •••
6 m

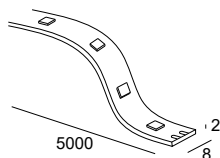

LED						24VDC
K	CRI	W	Real Lm	mm	Code	
2700	90	48	4720	5000	<b>91-7930</b>	- 00 - 00
3000	90	48	4908	5000	<b>91-7931</b>	- 00 - 00
4000	90	48	5265	5000	<b>91-A017</b>	- 00 - 00

## On Performance 9,6 RGBW

IP
20

••• + •••
8 m

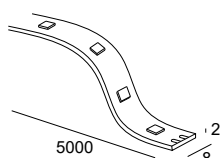

LED						24VDC
K	CRI	W	Real Lm	mm	Code	
RGBW	80	48	2688	5000	<b>91-A019</b>	- 00 - 00

## On Performance 9,6 IP65

IP
65

••• + •••
5 m

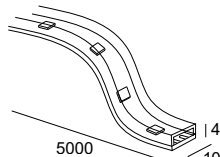

LED						24VDC
K	CRI	W	Real Lm	mm	Code	
3000	90	48	4585	5000	<b>91-A020</b>	- 00 - 00



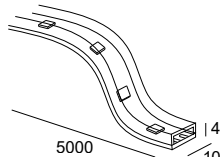

## On Performance 9,6 IP65 RGBW

IP
65

••• + •••
5 m



LED						24VDC
K	CRI	W	Real Lm	mm	Code	
RGBW	80	48	2576	5000	<b>91-A021</b>	- 00 - 00

On Performance 9,6	On Performance 9,6 RGBW	On Performance 9,6 IP65	On Performance 9,6 IP65 RGBW
			

**Fuentes de alimentación** P. 1166  
**Fontes de alimentação**

 CASAMBI IP67	<b>71-A242-00-00</b>	<b>71-A242-00-00</b>	<b>71-A242-00-00</b>	<b>71-A242-00-00</b>
------------------------------------------------------------------------------------------------	----------------------	----------------------	----------------------	----------------------



**Controladores** P. 1166  
**Controladores**

 CASAMBI IP20	-	-	-	<b>71-8050-00-00</b>
------------------------------------------------------------------------------------------------	---	---	---	----------------------

# On Performance 14,4

	50000h	3
	L80 B20	MacAdam

## On Performance 14,4

IP	*** + ***		
20	7 m		

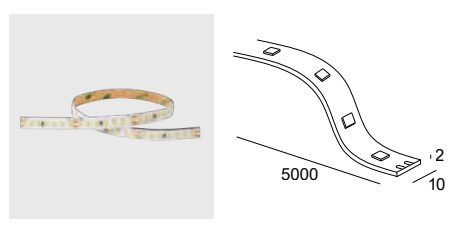

LED						 24VDC
K	CRI	W	Real Lm	mm	Code	
2700	90	72	7358	5000	<b>91-7932 - 00 - 00</b>	
3000	90	72	7620	5000	<b>91-7933 - 00 - 00</b>	
4000	90	72	7965	5000	<b>91-A022 - 00 - 00</b>	

## On Performance 14,4 IP65

IP	*** + ***		
65	5 m		

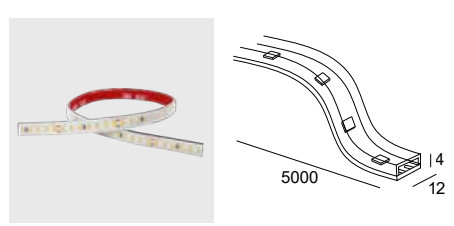

LED						 24VDC
K	CRI	W	Real Lm	mm	Code	
3000	90	72	6803	5000	<b>91-A023 - 00 - 00</b>	

## On Performance 14,4

## On Performance 14,4 IP65



**Fuentes de alimentación** P. 1166  
**Fontes de alimentação**

 CASAMBI IP67	<b>71-A242-00-00</b>	<b>71-A242-00-00</b>
--------------------------------------------------------------------------------------------------	----------------------	----------------------

# On Performance 19,2



50000h
L80 B20

3
MacAdam

## On Performance 19,2

IP
20

...
5 m

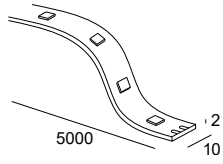

LED						24VDC
K	CRI	W	Real Lm	mm	Code	
2700	90	96	9658	5000	<b>91-7934</b>	- 00 - 00
3000	90	96	10060	5000	<b>91-7935</b>	- 00 - 00
4000	90	96	10462	5000	<b>91-7936</b>	- 00 - 00

## On Performance 19,2 RGB

IP
20

...
5 m

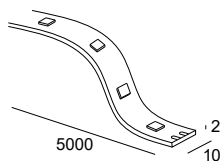

LED						24VDC
K	CRI	W	Real Lm	mm	Code	
RGB		72	3230	5000	<b>91-7937</b>	- 00 - 00
RGB-3000	90	96	4574	5000	<b>91-7938</b>	- 00 - 00
TW 2700-6500	90	96	7973	5000	<b>91-7939</b>	- 00 - 00

## On Performance 19,2 IP65

IP
65

...
5 m

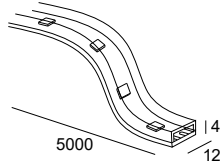

LED						24VDC
K	CRI	W	Real Lm	mm	Code	
2700	90	96	8844	5000	<b>91-A024</b>	- 00 - 00
3000	90	96	8970	5000	<b>91-A025</b>	- 00 - 00

On Performance 19,2



On Performance 19,2 RGB



On Performance 19,2 IP65



### Fuentes de alimentación Fontes de alimentação

P. 1166



CASAMBI  
IP67

71-A242-00-00

-

71-A242-00-00

### Controladores Controladores

P. 1166



CASAMBI  
IP20

-

71-8050-00-00

-



# On Performance 28,8



50000h  
L80 B20

3  
MacAdam

INDOOR

## On Performance 28,8

IP  
20

\*\*\* + \*\*\*  
5 m

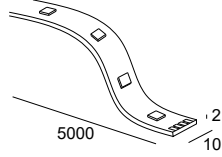

LED						24VDC
K	CRI	W	Real Lm	mm	Code	
2700	90	120	12643	5000	<b>91-7940</b>	- 00 - 00
3000	90	120	14510	5000	<b>91-7941</b>	- 00 - 00

### Fuentes de alimentación Fontes de alimentação

P. 1166



CASAMBI  
IP67

**71-A242-00-00**

# On Performance COB



50000h  
L80 B20

3  
MacAdam

TIRAS LED | FITAS LED

## On Performance COB

IP  
20

\*\*\* + \*\*\*  
5 m

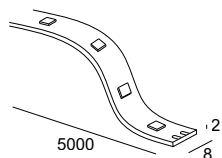

LED						24VDC
K	CRI	W	Real Lm	mm	Code	
3000	90	40	2586	5000	<b>91-A026</b>	- 00 - 00

### Fuentes de alimentación Fontes de alimentação

P. 1166



CASAMBI  
IP67

**71-A242-00-00**

---

# Señalización

# Sinalização



Paso

452

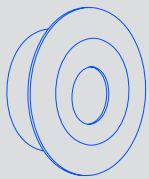

Click

457

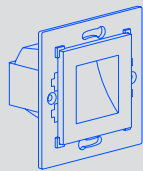

Bat

460

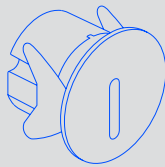

Sign

464

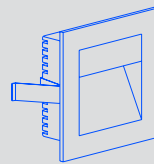

Secret

468

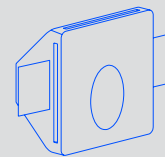

Step

469

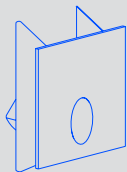

# Paso

## Iluminar sin ser visto Iluminar sem ser visto

Con efectos de luz que acompañan y guían, Paso se integra de manera excepcional, aportando una iluminación precisa y sutil a las zonas de tránsito, pasillos o escaleras.

Com efeitos de luz que acompanham e guiam, Paso integra-se de forma excepcional, proporcionando uma iluminação precisa e sutil em zonas de trânsito, corredores ou escadas.



Diferentes efectos de luz para adaptarse a cada necesidad  
 Diferentes efeitos de luz para se adaptar a cada necessidade

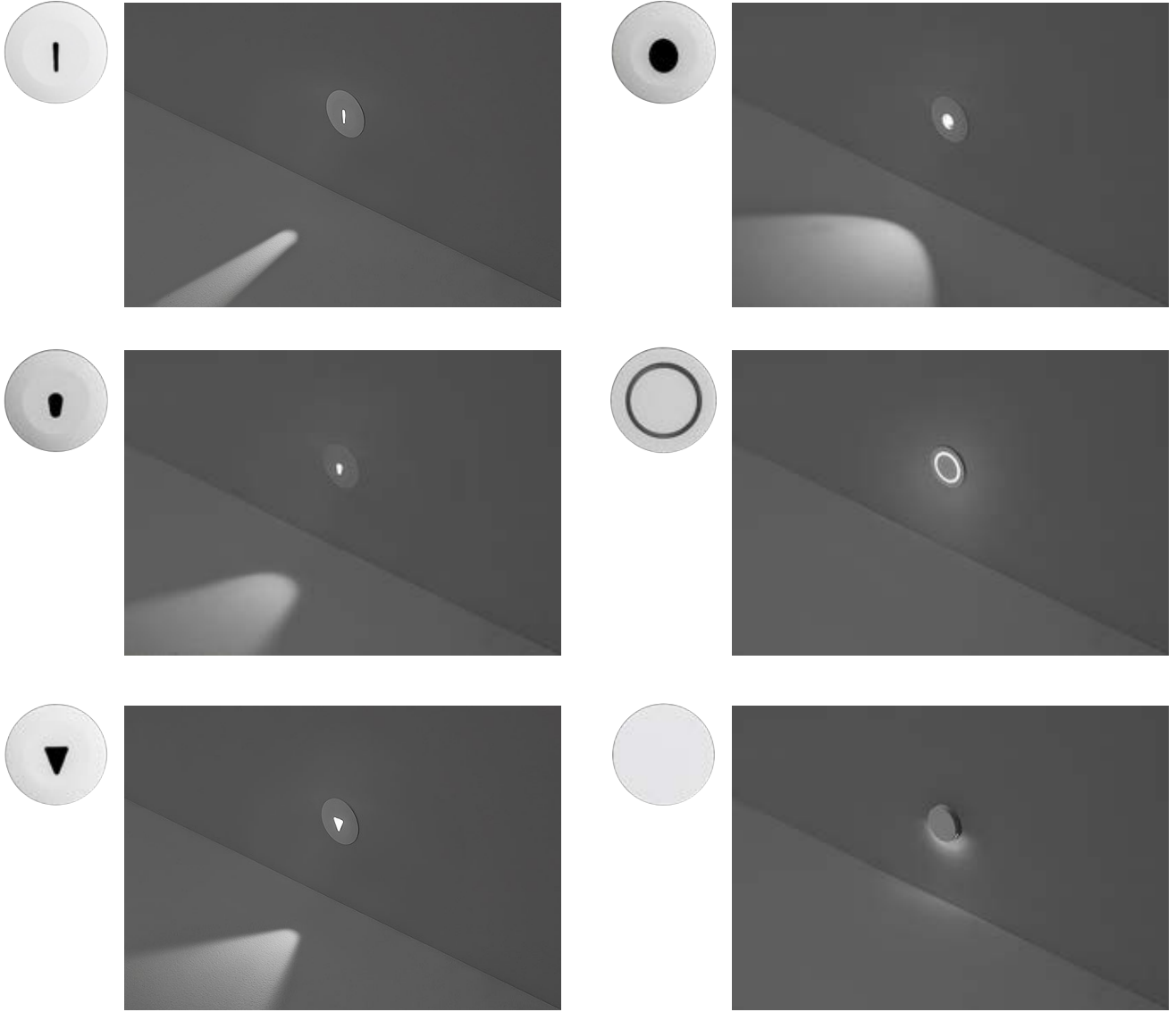

Mínima profundidad de empotramiento  
 Profundidade mínima de encastramento



# Paso

BODY MAT
AL

DIF MAT
PVC



50000h
L80 B20

3
MacAdam

## Paso A

IP
42



○  
14

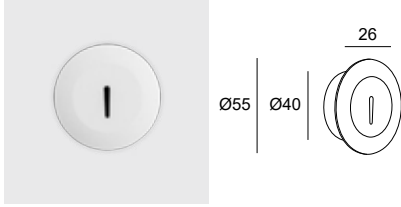

LED					max.350mA 3V
K	CRI	W	Real Lm	Code	
3000	80	1	9	<b>55-8024 - 14 - 00</b>	

⌀ 45 5-18 mm

## Paso B

IP
42



●  
N3

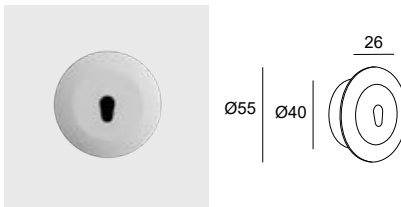

LED					max.350mA 3V
K	CRI	W	Real Lm	Code	
3000	80	1	19	<b>55-8025 - N3 - 00</b>	

⌀ 45 5-18 mm

## Paso C

IP
42



○  
14

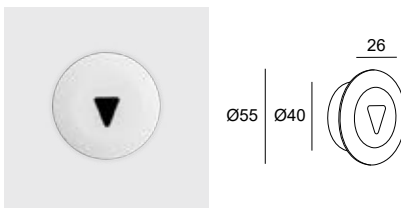

LED					max.350mA 3V
K	CRI	W	Real Lm	Code	
3000	80	1	25	<b>55-8026 - 14 - 00</b>	

⌀ 45 5-18 mm

**Paso D**

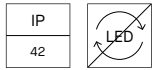

N3

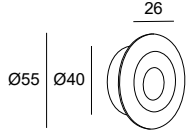

45 5-18 mm

LED					max.350mA 3V
K	CRI	W	Real Lm	Code	
3000	80	1	40	55-8027 - N3 - 00	

**Paso E**

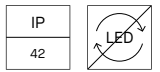

N3

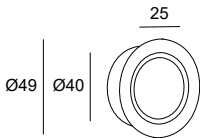
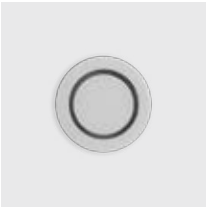

45 5-18 mm

LED					max.350mA 3V
K	CRI	W	Real Lm	Code	
3000	80	1	17	55-8028 - N3 - 00	

**Paso F**

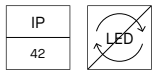

14

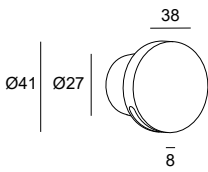

31 5-18 mm

LED					max.350mA 3V
K	CRI	W	Real Lm	Code	
3000	80	1	2	55-8029 - 14 - 00	



Paso A

Paso B

Paso C



**Drivers**  
Driver

P. 1166



ON-OFF  
IP20

71-8077-00-00

71-8077-00-00

71-8077-00-00



PHASE CUT 240V  
PUSH  
IP20

71-4898-00-00  
Min.1 - Max.16

71-4898-00-00  
Min.1 - Max.16

71-4898-00-00  
Min.1 - Max.16



1-10V  
PUSH  
IP20

71-7710-00-00  
Min.1 - Max.15

71-7710-00-00  
Min.1 - Max.15

71-7710-00-00  
Min.1 - Max.15



DALI2  
IP20

71-6192-00-00  
Min.1 - Max.15

71-6192-00-00  
Min.1 - Max.15

71-6192-00-00  
Min.1 - Max.15

**Accesorios de fijación**  
Acessórios de fixação



Caja de empotrar  
Caixa de encastrar

71-A775-00-00

71-A775-00-00

71-A775-00-00

Paso D

Paso E

Paso F



**Drivers**  
Driver

P. 1166



ON-OFF  
IP20

71-8077-00-00

71-8077-00-00

71-8077-00-00



PHASE CUT 240V  
PUSH  
IP20

71-4898-00-00  
Min.1 - Max.16

71-4898-00-00  
Min.1 - Max.16

71-4898-00-00  
Min.1 - Max.16



1-10V  
PUSH  
IP20

71-7710-00-00  
Min.1 - Max.15

71-7710-00-00  
Min.1 - Max.15

71-7710-00-00  
Min.1 - Max.15



DALI2  
IP20

71-6192-00-00  
Min.1 - Max.15

71-6192-00-00  
Min.1 - Max.15

71-6192-00-00  
Min.1 - Max.15

**Accesorios de fijación**  
Acessórios de fixação



Caja de empotrar  
Caixa de encastrar

71-A775-00-00

71-A775-00-00

71-A776-00-00



## Diseño limpio y compacto Design limpo e compacto

La colección Click es muy práctica, ya que se ha diseñado para que su instalación sea compatible con las cajas de mecanismos universales. El driver está incluido dentro de la luminaria, lo que facilita aún más la instalación. A coleção Click é muito prática, já que se foi concebida para que a sua instalação seja compatível com as caixas de mecanismos universais. O driver está incluído dentro da luminária, o que facilita ainda mais a instalação.

Perfecto para instalaciones tanto  
exteriores como interiores.  
Perfeito para instalações tanto  
exteriores como interiores.



Instalación en cajas de mecanismos universales  
 Instalação em caixas de mecanismos universais

Compatible con todas las cajas de mecanismos universales: cuadradas y redondas, de exterior y de interior, de obra y de pladur.  
 Compatível com todas as caixas de mecanismos universais: quadradas e redondas, de exterior e de interior, de obra e de pladur.

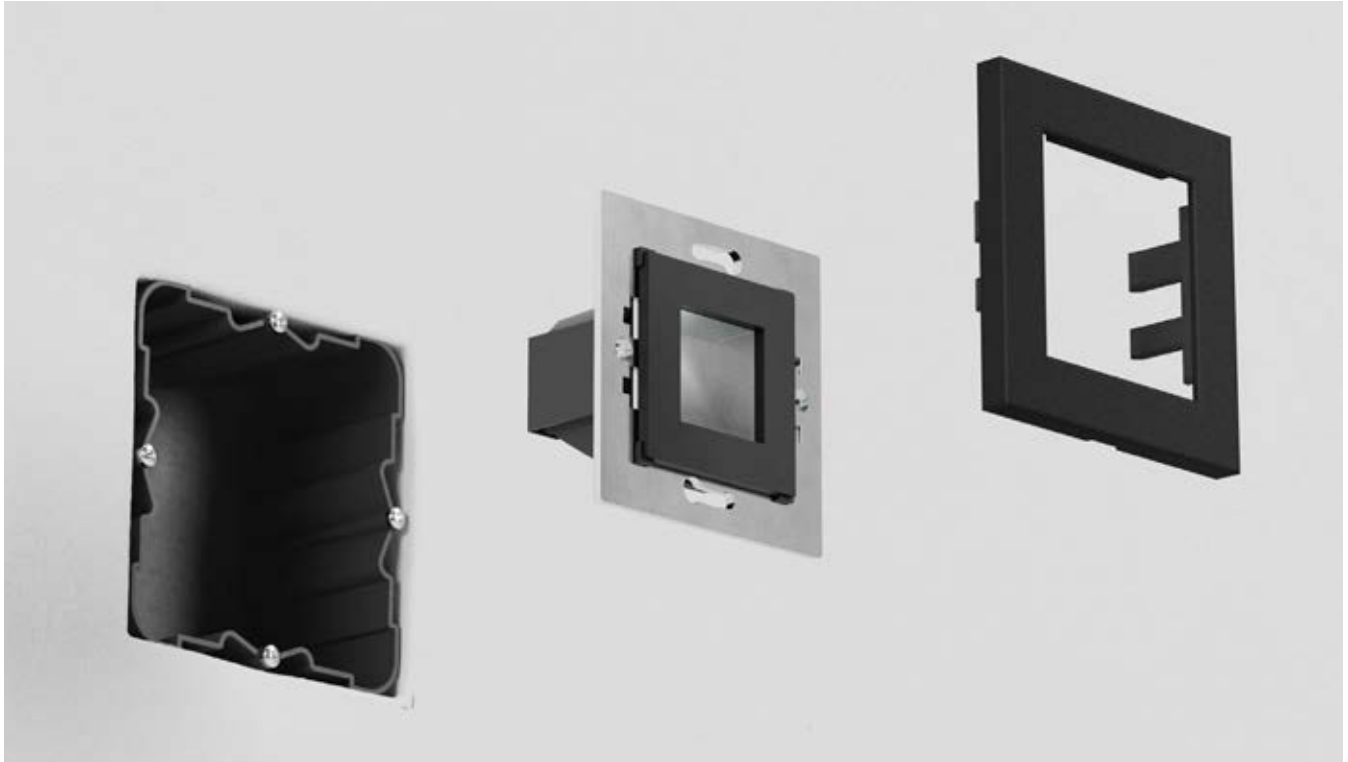

Click

BODY MAT PC	DIF MAT GLA		50000h L80 B20	IP 65	IK 07	 0 m	 DIM	
----------------	----------------	--	-------------------	----------	----------	---------	---------	--

●  
05

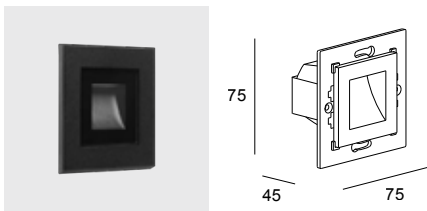

LED							
K	CRI	W Total	Real Lm	Code			
2700	80	1.4	31	<b>05-E141</b>	<b>- 05 - CK</b>	ON-OFF 220-240V	
3000	80	1.4	31	<b>05-E141</b>	<b>- 05 - CL</b>	ON-OFF 220-240V	

Accesorios de fijación  
 Acessórios de fixação



Frontal  
 Frontal

Z5 ●	<b>71-E489-Z5-Z5</b>
J6 ●	<b>71-E489-J6-J6</b>
14 ○	<b>71-E489-14-14</b>
60 ●	<b>71-E489-60-60</b>
34 ●	<b>71-E489-34-34</b>



# Bat



+ Bat

## La elasticidad de la luz en el mínimo espacio A elasticidade da luz no mínimo espaço

Bat es una propuesta de señalización cuidada al detalle, tanto en el modelado de la luz que emite, como en su estructura, con un cuerpo arenado que embellece aún más la fuga.

Bat é uma proposta de sinalização cuidada ao detalhe, tanto na modelação da luz que emite, como na sua estrutura, com um corpo texturizado com diferentes acabamentos.

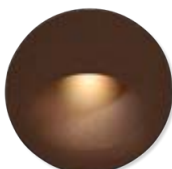
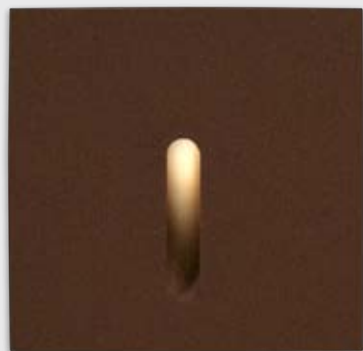





Distintos efectos para ajustarse a diversas necesidades de señalización.  
 Diferentes efeitos para ajustar-se a diferentes necessidades de sinalização.

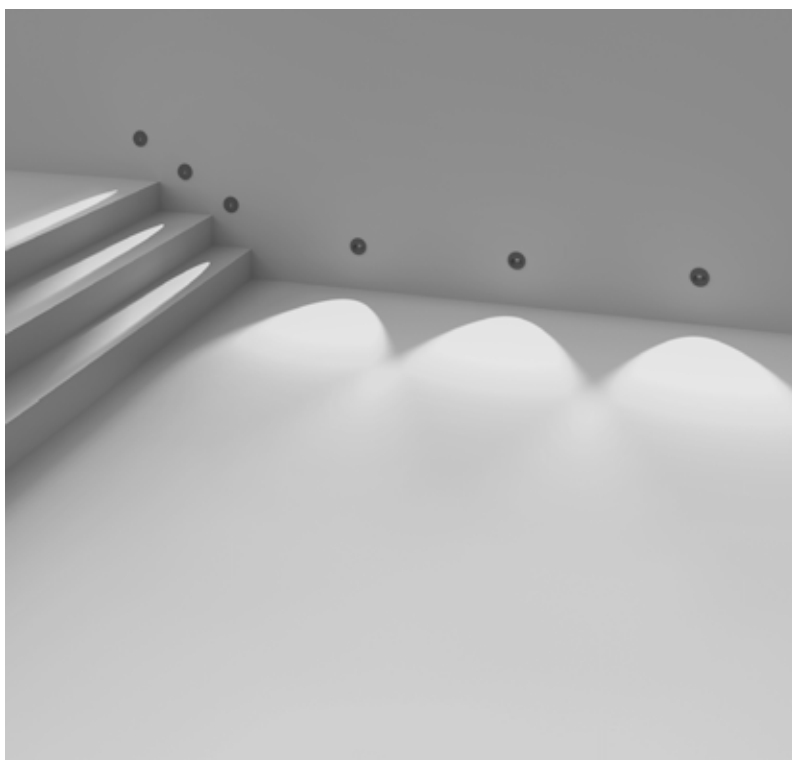

LED con disposición hundida para un máximo confort.  
 LED com disposição afundada para o máximo conforto.



Aletas para instalación en pladur y prensaestopa especial antiapertura que garantiza su estanqueidad en espacios exteriores.  
 Aletas para instalação no pladur e bucim especial antiabertura que garante a sua estanqueidade em espaços exteriores.



Driver integrado  
 Driver integrado

Controlador remoto  
 Controlador remoto

BODY MAT	DIF MAT	50000h	3
AL	GLA	L80 B20	MacAdam

## Bat Square Lineal

IP	IK	UGR			
66	10	<16		1 m	

Z5 14 J6

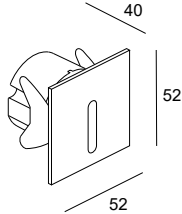

43

LED						max.700mA 3V	
K	CRI	W	Real Lm	Optics	Code		
2700	90	2.2	10	23°	<b>05-E017</b>	<b>Z5</b>	<b>- J6 - CK</b>
						<b>14</b>	
3000	90	2.2	10	23°	<b>05-E017</b>	<b>Z5</b>	<b>- J6 - CL</b>
						<b>14</b>	
4000	90	2.2	10	23°	<b>05-E017</b>	<b>Z5</b>	<b>- J6 - CM</b>
						<b>14</b>	

## Bat Square Lineal Driver

	IP	IK	UGR					
	66	10	<16		1 m			

Z5 14 J6

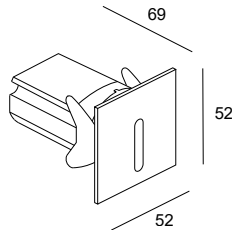

LED							
K	CRI	W Total	Real Lm	Optics	Code		
2700	90	3	10	23°	<b>05-E112</b>	<b>Z5</b>	<b>- J6 - CK</b>
						<b>14</b>	
3000	90	3	10	23°	<b>05-E112</b>	<b>Z5</b>	<b>- J6 - CL</b>
						<b>14</b>	
4000	90	3	10	23°	<b>05-E112</b>	<b>Z5</b>	<b>- J6 - CM</b>
						<b>14</b>	



### Bat Square Oval

IP 66	IK 10	UGR <16			
----------	----------	------------	--	--	--

Z5 14 J6

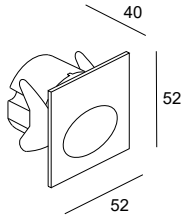
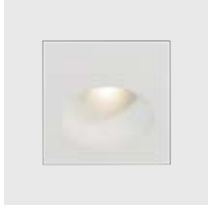

43

LED								
K	CRI	W	Real Lm	Optics	Code			
2700	90	2.2	77	60°	<b>05-E016</b>	<b>Z5</b>	<b>- J6 - CK</b>	<b>14</b>
3000	90	2.2	77	60°	<b>05-E016</b>	<b>Z5</b>	<b>- J6 - CL</b>	<b>14</b>
4000	90	2.2	77	60°	<b>05-E016</b>	<b>Z5</b>	<b>- J6 - CM</b>	<b>14</b>

### Bat Square Oval Driver

	IP 66	IK 10	UGR <16					
--	----------	----------	------------	--	--	--	--	--

Z5 14 J6

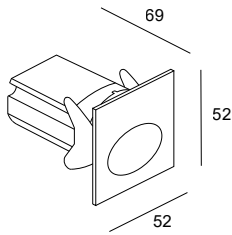

LED								
K	CRI	W Total	Real Lm	Optics	Code			
2700	90	3	77	60°	<b>05-E111</b>	<b>Z5</b>	<b>- J6 - CK</b>	<b>14</b>
3000	90	3	77	60°	<b>05-E111</b>	<b>Z5</b>	<b>- J6 - CL</b>	<b>14</b>
4000	90	3	77	60°	<b>05-E111</b>	<b>Z5</b>	<b>- J6 - CM</b>	<b>14</b>

### Bat Round Lineal

IP 66	IK 10	UGR <16			
----------	----------	------------	--	--	--

Z5 14 J6

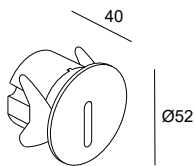

43

LED								
K	CRI	W	Real Lm	Optics	Code			
2700	90	2.2	10	23°	<b>05-E015</b>	<b>Z5</b>	<b>- J6 - CK</b>	<b>14</b>
3000	90	2.2	10	23°	<b>05-E015</b>	<b>Z5</b>	<b>- J6 - CL</b>	<b>14</b>
4000	90	2.2	10	23°	<b>05-E015</b>	<b>Z5</b>	<b>- J6 - CM</b>	<b>14</b>

### Bat Round Lineal Driver

NEW IP 66 IK 10 UGR <16 1 m SEA SIDE SUITABLE LED DRIVER

Z5 14 J6

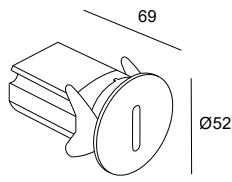

LED						
K	CRI	W Total	Real Lm	Optics	Code	
2700	90	3	10	23°	05-E110	Z5 - J6 - CK 14
3000	90	3	10	23°	05-E110	Z5 - J6 - CL 14
4000	90	3	10	23°	05-E110	Z5 - J6 - CM 14

### Bat Round Oval

IP 66 IK 10 UGR <16 1 m SEA SIDE SUITABLE

Z5 14 J6

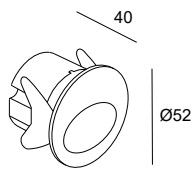

43

LED						
K	CRI	W	Real Lm	Optics	Code	
2700	90	2.2	77	60°	05-E014	Z5 - J6 - CK 14
3000	90	2.2	77	60°	05-E014	Z5 - J6 - CL 14
4000	90	2.2	77	60°	05-E014	Z5 - J6 - CM 14

max.700mA 3V

### Bat Round Oval Driver

NEW IP 66 IK 10 UGR <16 1 m SEA SIDE SUITABLE LED DRIVER

Z5 14 J6

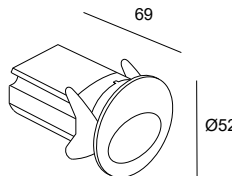
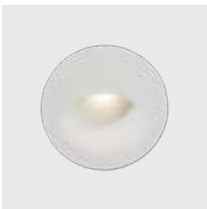

LED						
K	CRI	W Total	Real Lm	Optics	Code	
2700	90	3	77	60°	05-E108	Z5 - J6 - CK 14
3000	90	3	77	60°	05-E108	Z5 - J6 - CL 14
4000	90	3	77	60°	05-E108	Z5 - J6 - CM 14

Bat Square Lineal      Bat Square Lineal Driver      Bat Square Oval      Bat Square Oval Driver



### Accesorios de fijación Acessórios de fixação



Caja de empotrar  
Caixa de encastrar

60 ●	71-E065-60-00	71-E065-60-00	71-E065-60-00	71-E065-60-00
34 ○	71-E404-00-00	71-E404-00-00	71-E404-00-00	71-E404-00-00

### Accesorios de conexión Acessórios de conexão



Conector anticondensación IP68 (1 entrada + 1 salida) Ø 5,5 - 12mm, 4 polos  
Conetor anticondensação IP68 (2 entradas de Ø 5,5 - 12mm) 4 polos

71-E112-00-00      71-E112-00-00      71-E112-00-00      71-E112-00-00



Conector anticondensación IP68 (1 entrada + 3 salidas) Ø 5,5 - 12mm, 4 polos  
Conetor anticondensação IP68 (4 entradas de Ø 5,5 - 12mm) 4 polos

-      71-E122-00-00      -      71-E122-00-00



Caja de conexión IP67 (1 entrada + 2 salidas) Ø 6 - 7,5mm, 3 polos  
Caixa de ligação IP67 (3 entradas de Ø 6 - 7,5mm) 3 polos

05 ●      71-9262-05-05      -      71-9262-05-05      -



Caja de conexión IP68 (1 entrada + 5 salidas) Ø 6,5 - 11mm, 6 polos  
Caixa de ligação IP68 (6 entradas de Ø 6,5 - 11mm) 6 polos

05 ●      71-9199-05-05      71-9199-05-05      71-9199-05-05      71-9199-05-05

Bat Round Lineal

Bat Round Lineal Driver

Bat Round Oval

Bat Round Oval Driver



### Accesorios de fijación Acessórios de fixação



Caja de empotrar  
Caixa de encastrar

60 ●	71-E065-60-00	71-E065-60-00	71-E065-60-00	71-E065-60-00
34 ○	71-E404-00-00	71-E404-00-00	71-E404-00-00	71-E404-00-00

### Accesorios de conexión Acessórios de conexão



Conector anticondensación IP68 (1 entrada + 1 salida) Ø 5,5 - 12mm, 4 polos  
Conetor anticondensação IP68 (2 entradas de Ø 5,5 - 12mm) 4 polos

71-E112-00-00      71-E112-00-00      71-E112-00-00      71-E112-00-00



Conector anticondensación IP68 (1 entrada + 3 salidas) Ø 5,5 - 12mm, 4 polos  
Conetor anticondensação IP68 (4 entradas de Ø 5,5 - 12mm) 4 polos

-      71-E122-00-00      -      71-E122-00-00



Caja de conexión IP67 (1 entrada + 2 salidas) Ø 6 - 7,5mm, 3 polos  
Caixa de ligação IP67 (3 entradas de Ø 6 - 7,5mm) 3 polos

05 ●      71-9262-05-05      -      71-9262-05-05      -



Caja de conexión IP68 (1 entrada + 5 salidas) Ø 6,5 - 11mm, 6 polos  
Caixa de ligação IP68 (6 entradas de Ø 6,5 - 11mm) 6 polos

05 ●      71-9199-05-05      71-9199-05-05      71-9199-05-05      71-9199-05-05

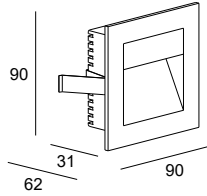

LED					max.700mA 3V
K	CRI	W	Real Lm	Code	
3000	80	2.2	80	EP-0356 - 14 - 00	

80x120

## Drivers

P. 1166

	ON-OFF IP20	71-3542-00-00
	PHASE CUT 240V PUSH IP20	71-4898-00-00
	1-10V PUSH IP20	71-7710-00-00
	DALI2 IP20	71-6192-00-00

## Accesorios de fijación

Caja para empotrar  
Caixa de encastrar

Included

# Secret

BODY MAT  
PLSTER

DIF MAT  
PC



50000h  
L80 B20

3  
MacAdam

## Secret A

IP  
20



14

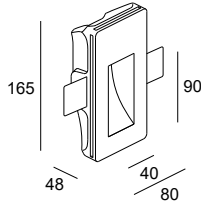

170x85 9-15 mm

LED					max.350mA 3V
K	CRI	W	Real Lm	Code	
3000	80	1	69	05-1804 - 14 - 00	

## Secret B

IP  
20



14

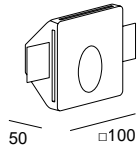

105x105 6-16 mm

LED					max.350mA 3V
K	CRI	W	Real Lm	Code	
3000	80	1	93	05-2904 - 14 - 00	

### Secret A

### Secret B



## Drivers

P. 1166

Driver	Secret A	Secret B
<p>ON-OFF IP20</p>	71-8077-00-00	71-8077-00-00
<p>PHASE CUT 240V PUSH IP20</p>	71-4898-00-00 Min.1 - Max.16	71-4898-00-00 Min.1 - Max.16
<p>1-10V PUSH IP20</p>	71-7710-00-00 Min.1 - Max.15	71-7710-00-00 Min.1 - Max.15
<p>DALI2 IP20</p>	71-6192-00-00 Min.1 - Max.15	71-6192-00-00 Min.1 - Max.15

## Step Round

IP
20

NEW
-----

LED
-----

14

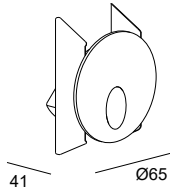

LED						
K	CRI	W Total	Real Lm	Code		
3000	80	4	194	<b>55-1573</b>	- 14	- 00 ON-OFF 220-240V



## Step Square

NEW
-----

IP
20

LED
-----

14

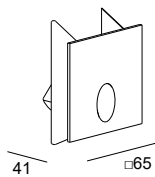

LED						
K	CRI	W Total	Code			
3000	80	4	<b>55-1574</b>	- 14	- 00 ON-OFF 220-240V	



Step Round



Step Square



### Accesorios de fijación Acessórios de fixação



Caja para empotrar  
Caixa de encastrar

Included

Included

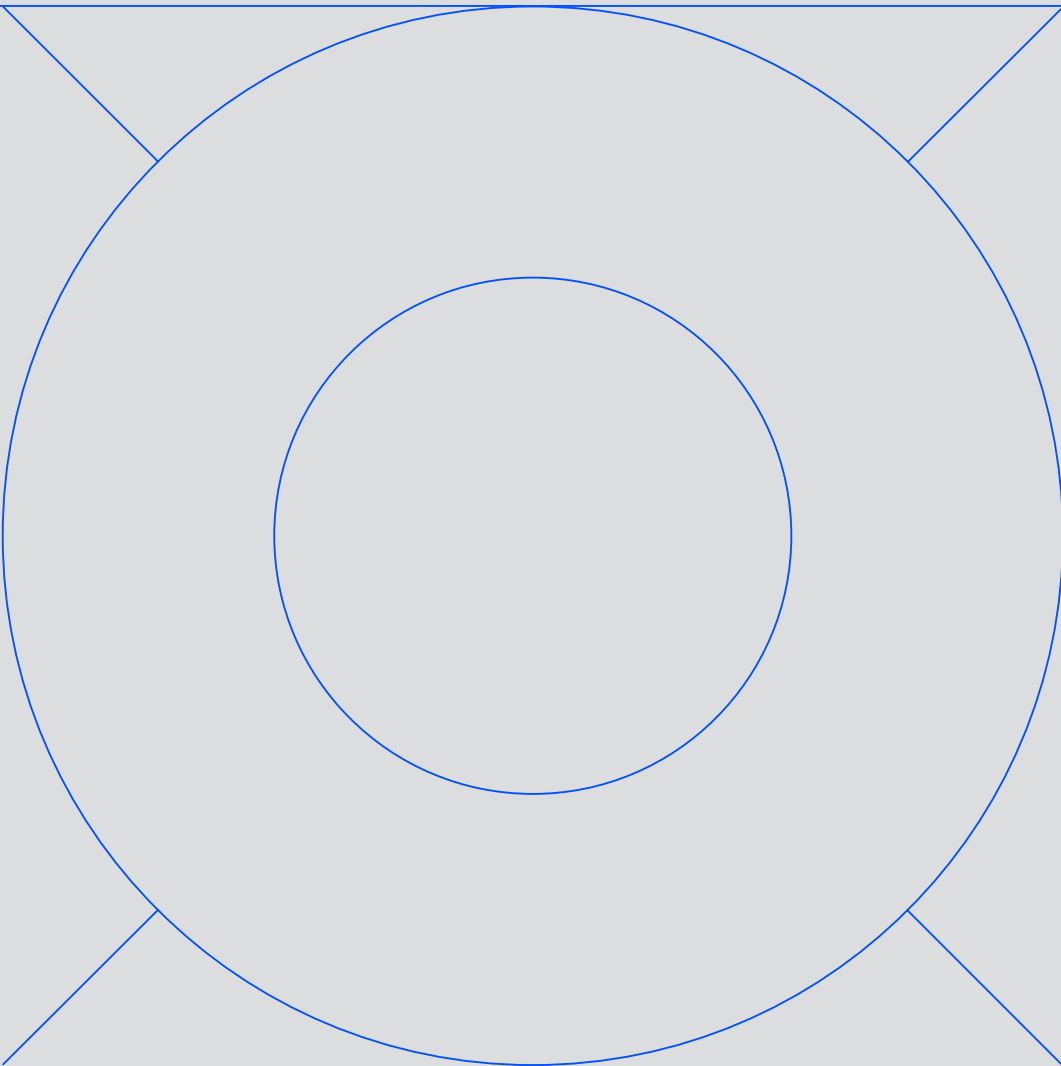

# Outdoor



472

Outdoor  
Collections

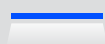

516

Sistemas Lineales  
Sistemas Lineares



614

Proyectors  
Projetores



668

Sumergibles  
Submersíveis



734

Empotrables de techo  
Encastráveis de teto



754

Empotrables de pared  
Encastráveis de parede



674

Empotrables de suelo  
Encastráveis no solo



772

Uplights superficie  
Uplights superficie



782

Balizas y Farolas  
Balizas / Postes de iluminação



854

Apliques  
Apliques



922

Plafones  
Plafons



946

Chillout



# Outdoor Collections

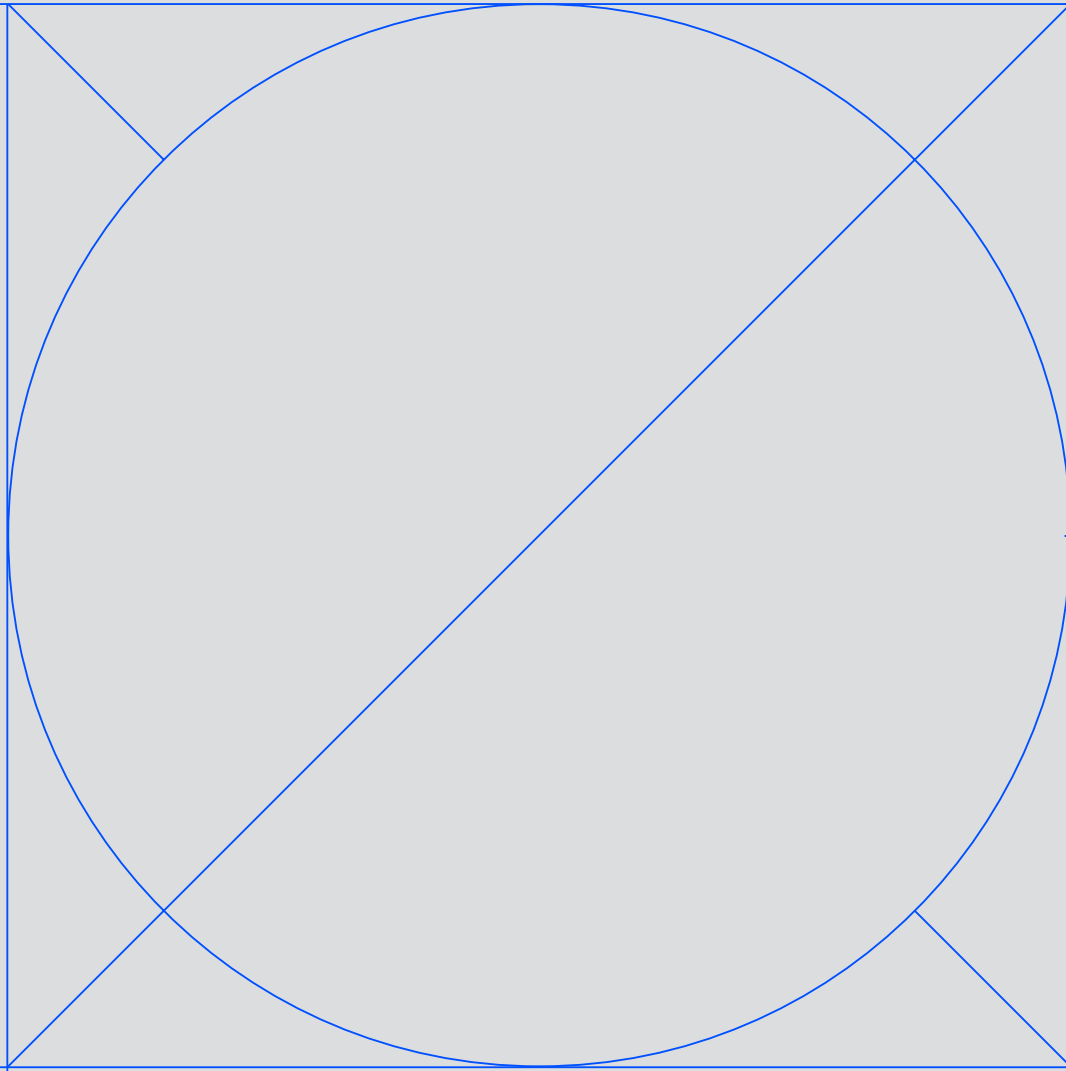

Max

472

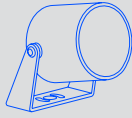
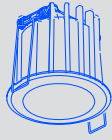

Modis

488

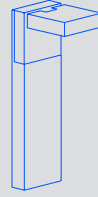
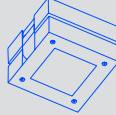
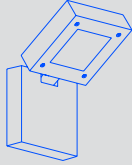
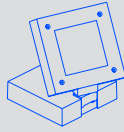

Orbit

496



Rack

506

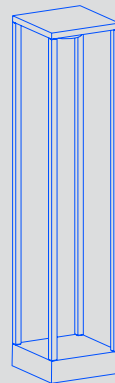
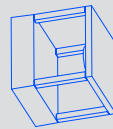
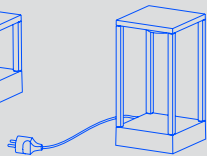
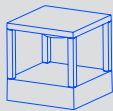

# Max

Designed by LedsC4 Architectural



+ Max

## Iluminación in-out Iluminação in-out

Esta extensa colección, con distintas aplicaciones y combinaciones, está pensada para iluminar nuevos espacios, en los que el interior y el exterior están más conectados que nunca, compartiendo un mismo concepto y arquitectura.

Esta extensa coleção, com diferentes aplicações e combinações, foi concebida para iluminar novos espaços, nos quais o interior e o exterior estão mais ligados do que nunca, partilhando o mesmo conceito e a mesma arquitetura.

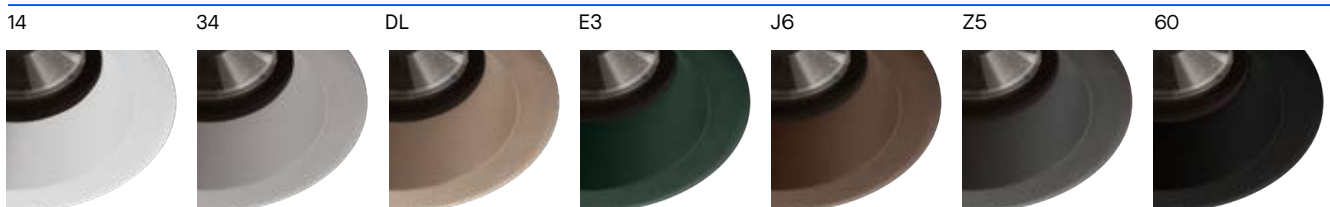
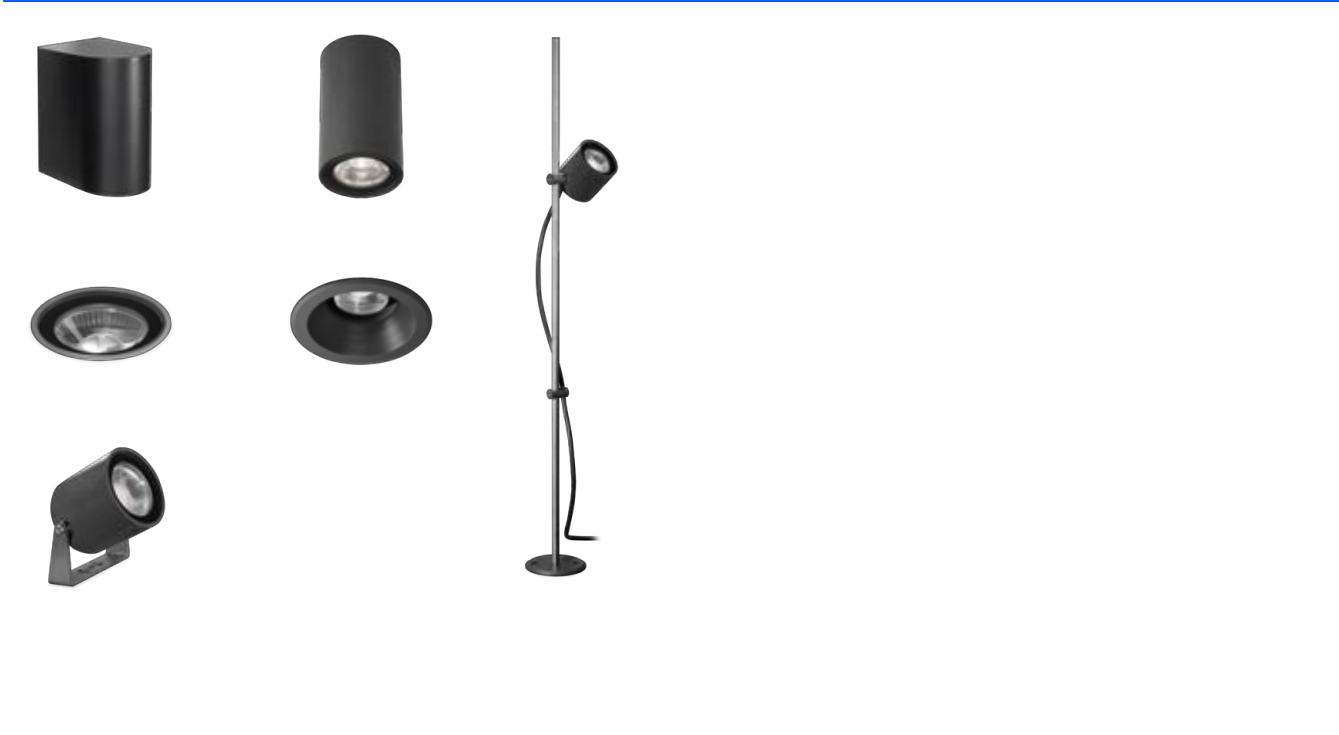



**Downlight**  
**736**

**Uplight**  
**676**

Comfort      Round      Square

Trimless      Round      Square

Ø 58 mm      Ø 47 mm      ∅ 47 mm

Ø 32 mm      Ø 47 mm      ∅ 47 mm

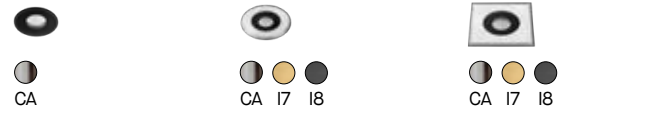

Ø 100 mm      Ø 75 mm      ∅ 75 mm

Ø 58 mm      Ø 75 mm      ∅ 75 mm



Ø 140 mm      Ø 110 mm      ∅ 110 mm

Ø 83 mm      Ø 110 mm      ∅ 110 mm



2700K/3000K/4000K  
2.2 - 17.3 W

2700K/3000K/4000K  
2.2 - 17.3 W



US - UF

US - UF



**Spotlight**  
**626**

**Bollard**  
**810**

**Wall Fixture**  
**861**

**Ceiling**  
**924**

Surface

Single Emission

Double Emission

Ceiling

Ø 30 mm

Ø 30 mm x H 450 mm

L 85 x W 62 x H 100 mm

L 85 x W 62 x H 135 mm

Ø 58 x H 160 mm



ON-OFF



ON-OFF



ON-OFF

Ø 58 mm

Ø 58 mm x H 600 mm

L 85 x W 62 x H 204 mm

L 85 x W 62 x H 245 mm

Ø 58 x H 251 mm



DALI-2 / CASAMBI



DALI-2 / CASAMBI



DALI-2 / CASAMBI



Ø 82 mm

Ø 82 mm x H 800 mm

L 92 x W 113 x H 200 mm

L 92 x W 113 x H 280 mm

Ø 83 x H 230 mm



ON-OFF/DALI/CASAMBI



ON-OFF/DALI/CASAMBI



ON-OFF/DALI/CASAMBI



2700K/3000K/4000K  
2.2 - 17.3 W



US - UF

○ ● ● ● ● ● ● ●  
14 60 34 DL E3 J6 Z5

2700K/3000K/4000K  
4 - 31,5 W



US - UF

○ ● ● ● ● ● ● ●  
14 60 34 DL E3 J6 Z5



US - UF

2700K/3000K/4000K  
4 - 17,3 W



US - UF

○ ● ● ● ● ● ● ●  
14 60 34 DL E3 J6 Z5



Sin difusor  
Sem difusor

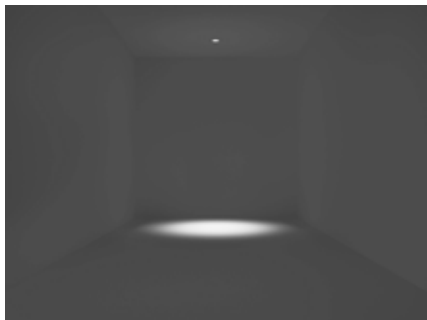

Panel de abeja  
Painel de abelha



Difusor opal  
Difusor opalino

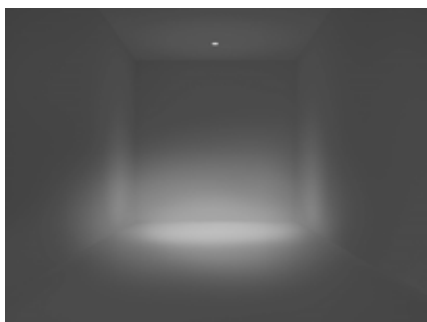

Difusor cuadrado  
Difusor quadrado

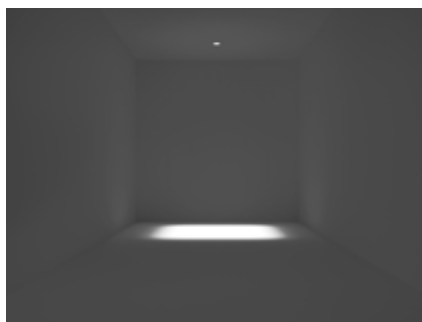

Difusor elíptico  
Difusor elíptico

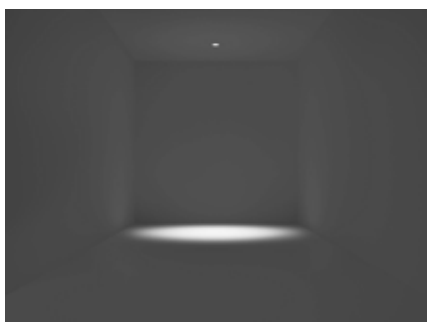

Difusor wall washer  
Difusor wall washer

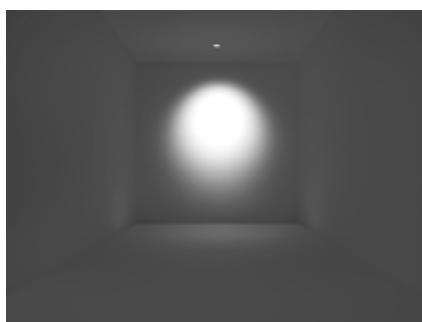



Nuevos modelos más pequeños  
Novos modelos mais pequenos



60 mm



# Max

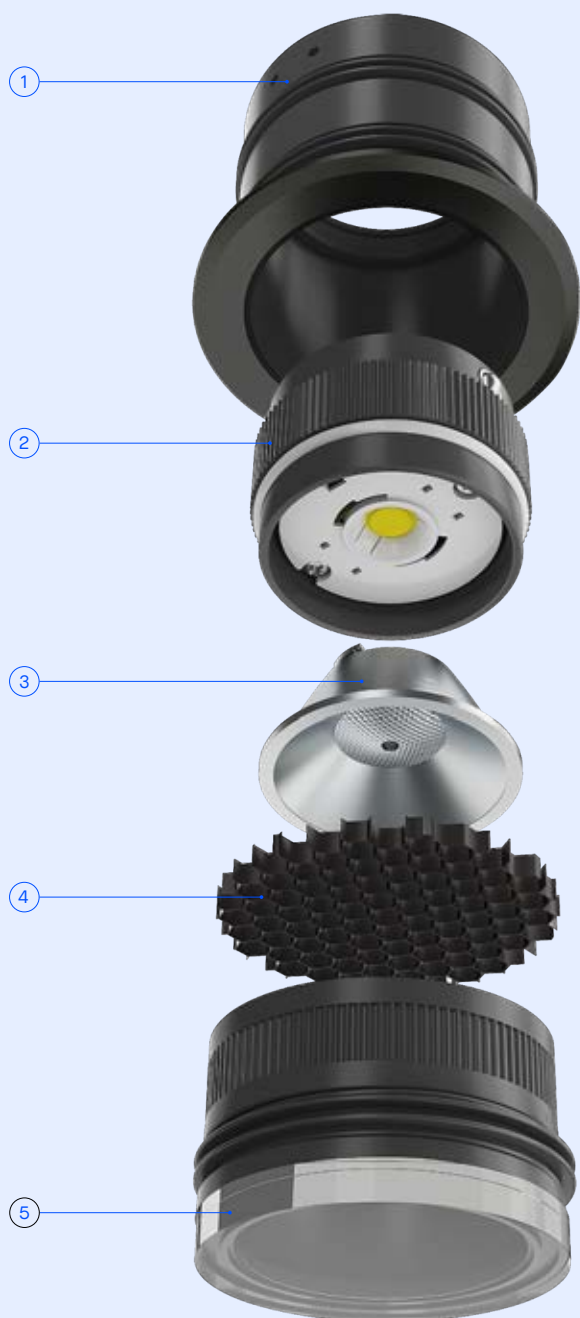

Trimless

Round

Square

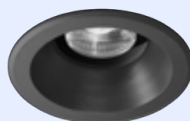

## Accesorios ópticos Acessórios óticos

- 1 Difusor elíptico (5u.)  
Difusor elíptico (5u.)
- 2 Difusor cuadrado (5u.)  
Difusor quadrado (5u.)
- 3 Difusor opal (5u.)  
Difusor opalino (5u.)
- 4 Panel de abeja (5u.)  
Painel de abelha (5u.)
- 5 Difusor wall washer (5u.)  
Difusor wall washer (5u.)

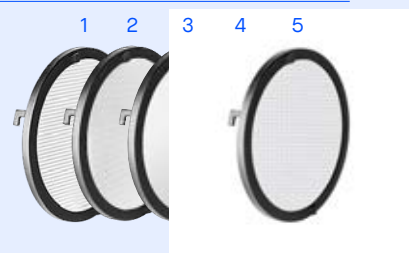

- 1 **Estructura**  
**Estrutura**  
Downlight Trimless  
Downlight Round  
Downlight Square

- 2 **Módulos LED**  
**eco-diseñados para**  
**ser reemplazables**  
**Módulos LED**  
**eco-projetados para**  
**serem substituíveis**

- 3 **Óptica**  
**Ótica**  
Ángulos de apertura:  
8,6° - 17° - 27° - 50°  
Ângulo de abertura:  
8,6° - 17° - 27° - 50°

- 4 **Accesorios ópticos**  
**Acessórios óticos**

- 5 **Cierre**  
**Fecho**  
Cierre hermético para  
garantizar IP66  
Fecho hermético para  
garantir IP66



# Precisión Precisão

9°

17°

27°

50°

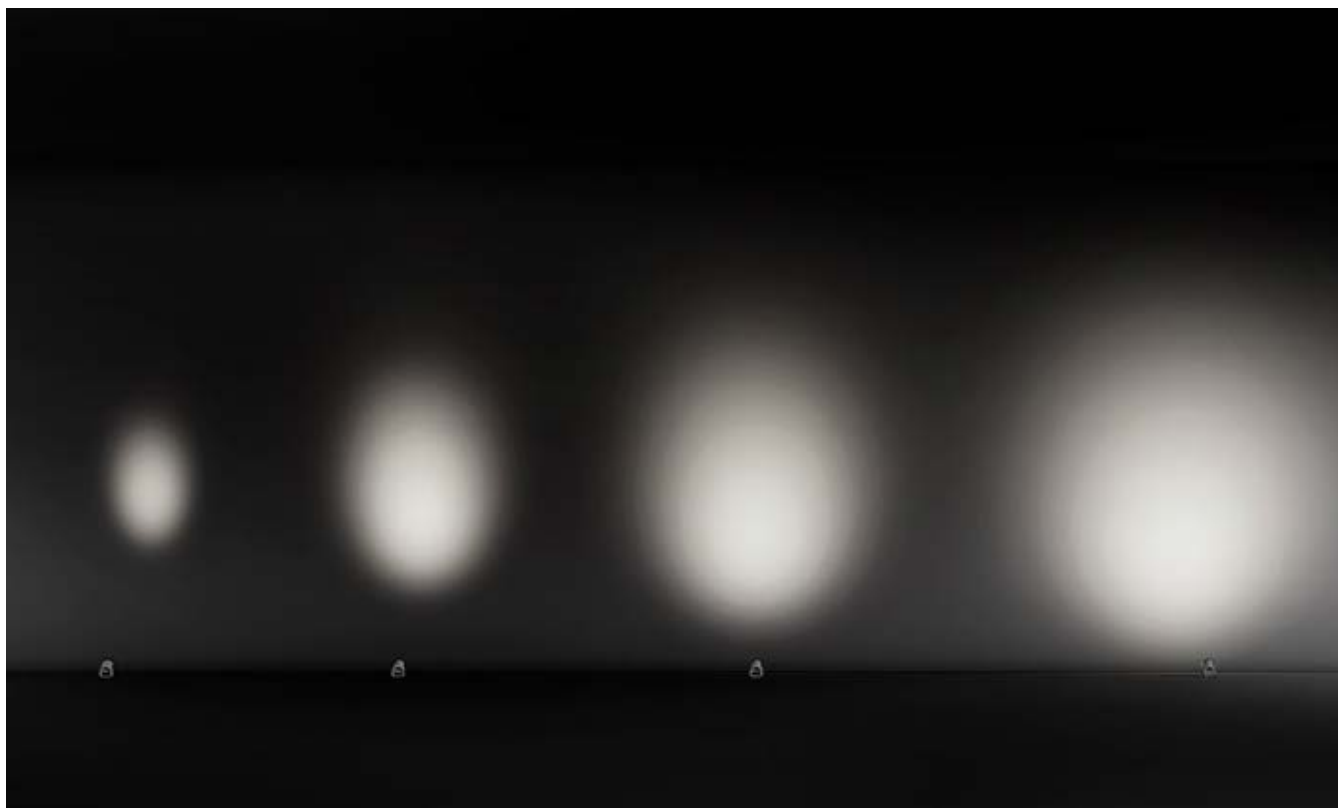

Ópticas del modelo Medium.  
Óticas do modelo Medium.

Small  
Ø35mm

Medium  
Ø50mm

Big  
Ø75mm



Distintos tamaños y potencias para todas las aplicaciones  
Diferentes tamanhos e potências para todas as aplicações

# Extensa gama de acabados

## Extensa gama de acabamentos



Acabados pintados para empotrables de techo, proyectores, balizas, apliques y plafones.  
Acabamentos pintados para encastráveis de teto, projetores, balizas, apliques e plafons.

### Nuevos acabados metálicos para empotrables de suelo

### Novos acabamentos metálicos para encastráveis de chão

Acero inoxidable  
Aço inoxidável



Latón dorado  
Latão dourado



Cromo bruñido  
Cromado polido













Modelos con CRI90  
Modelos com CRI90



Módulos LED fácilmente  
intercambiables  
Módulos LED facilmente  
intercambiáveis





# Modis

Designed by Luca Turrini



+ Modis



Colección concebida para iluminar diferentes espacios de un mismo proyecto de una forma elegante y precisa. Destaca por la versatilidad de modelos, opciones y prestaciones. El diseño de su doble rótula permite mover el cabezal en cualquier dirección para orientar la luz allí donde realmente se necesita.

Coleção concebida para iluminar diferentes espaços de um mesmo projeto de uma forma elegante e precisa. Destaca-se pela sua versatilidade de modelos, opções e prestações. O design da sua dupla junta esférica permite que a cabeça seja movida em qualquer direção para dirigir a luz para onde é realmente necessária.

Máximo exponente de versatilidad  
Máximo expoente de versatilidade

Modis Opal

Modis Optics



14

34

DL

E3

J6

Z5

60





Spotlight  
634

Wall Fixture  
857

Ceiling  
932

140 × 140 mm



428 × 140 mm



800 × 140 mm



Opal  
13,2 - 26,4 W

Optics  
21 - 42 W

Opal  
13,2 - 26,4 W

Optics  
21 - 42 W

Opal  
13,2 - 26,4 W

Optics  
21 - 42 W



GL

S - F - UF

GL

S - F - UF

GL

S - F - UF

○ ● ● ● ● ● ● ●  
14 60 34 DL E3 J6 Z5



**Bollard**  
**790**

**Lampost**  
**790**

140 × 500 mm

140 × 2300 mm



140 × 1000 mm

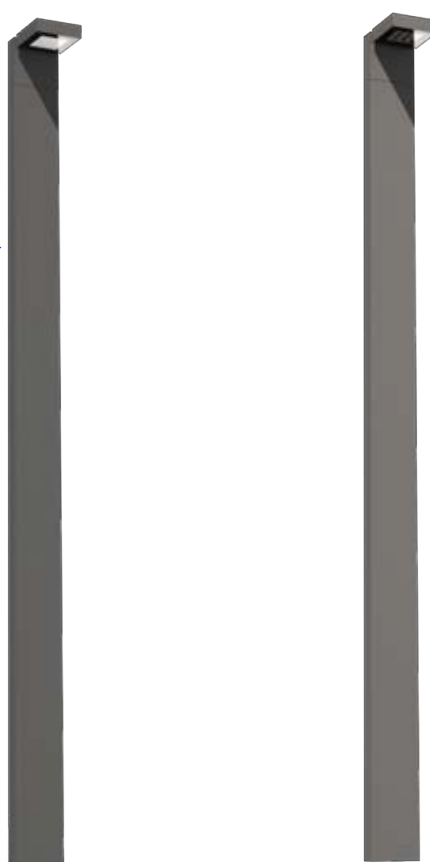
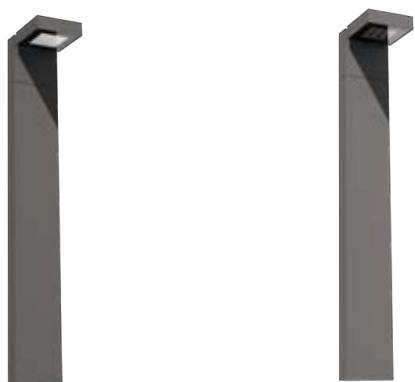

Opal  
13,2 - 26,4 W

Optics  
21 - 42 W

Opal  
13,2 - 26,4 W

Optics  
21 - 42 W



GL

S - F - UF

GL

S - F - UF

○ ● ● ● ● ● ● ●  
14 60 34 DL E3 J6 Z5



## Smart

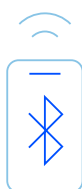

**Disponible con los protocolos DALI2 y Casambi**  
**Disponível nos protocolos DALI2 e Casambi**

Mediante la funcionalidad Smart, la colección Modis consigue un gran ahorro energético gracias a la gestión de luminarias punto a punto, por grupos o escenas, por control por ocupación y por programaciones horarias, entre otras.

Através da funcionalidade Smart, a coleção Modis consegue uma grande poupança energética graças à gestão de luminárias ponto a ponto, por grupos ou cenas, por controlo de ocupação e por programações horárias, entre outras.



Ejemplo de control via Bluetooth Casambi.  
 Exemplo de controlo via Bluetooth Casambi.



Rotación  
del cabezal  
Rotação  
da cabeça

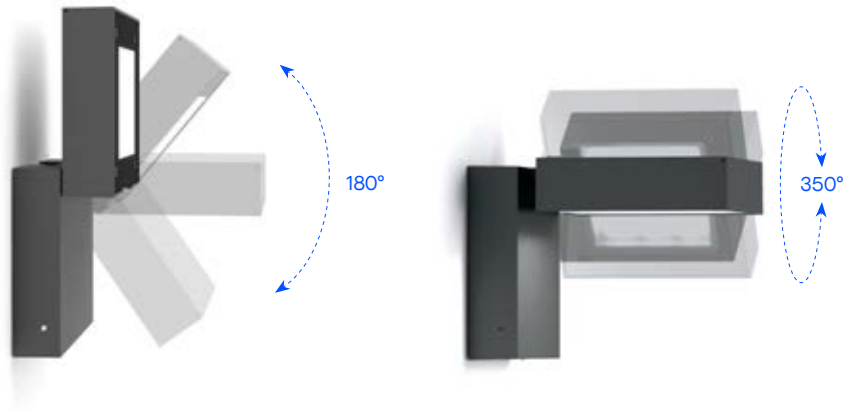

Efectos de luz  
Efeitos de luz

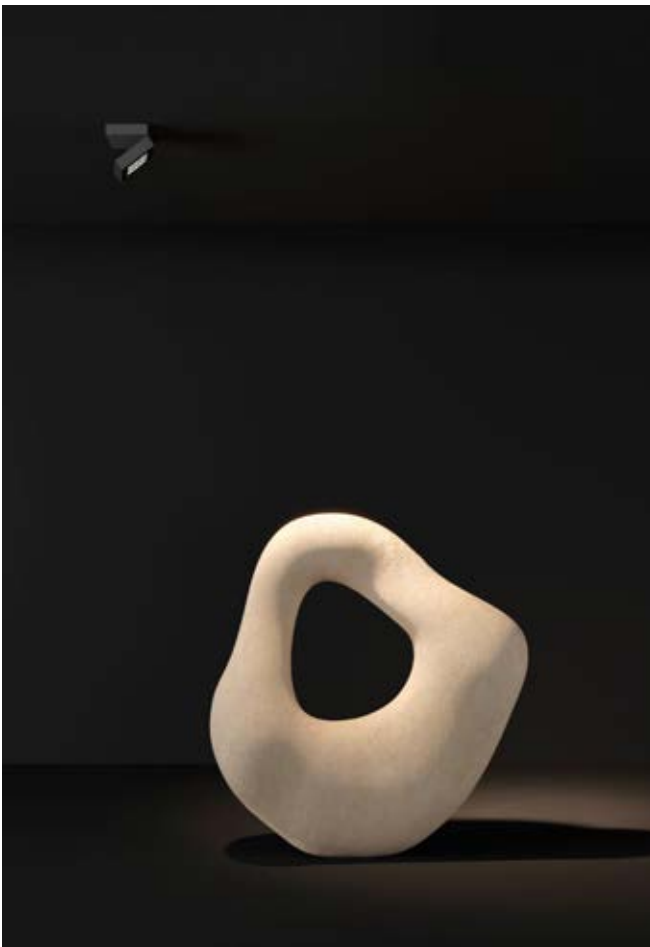

**Modis Optics**  
Para iluminación focalizada.  
Para iluminação focalizada.



**Modis Opal**  
Para iluminación general.  
Para iluminação geral.





Múltiples aplicaciones  
con una misma estética  
Múltiplas aplicações com  
uma mesma estética





# Orbit

Designed by Luca Turrini



+ Orbit

## Perfecto diálogo entre tecnicidad y belleza Diálogo perfeito entre tecnicidade e beleza

Detallista y minuciosa, Orbit es el elemento diferencial que transforma la vida a su alrededor, iluminando vegetación, objetos o ambientes de forma cálida y elegante. La sencillez de su silueta aporta un valor añadido, ya que cede todo el protagonismo a la luz, trabajada al detalle para ofrecer altas prestaciones técnicas con diversas opciones de direccionamiento del haz de luz.

Detalhista e minucioso, Orbit é o elemento diferenciador que transforma a vida à sua volta, iluminando vegetação, objetos ou ambientes de uma forma cálida e elegante. A simplicidade da sua silhueta proporciona um valor acrescentado, uma vez que dá todo o protagonismo à luz, trabalhada em detalhe para oferecer elevadas prestações técnicas de direccionamento do feixe de luz.



300 mm    1060 mm    1800 mm    500 mm    900 mm    2300 mm



14    34    DL    E3    J6    Z5    60







Table Lamp

958

Rechargeable

300 mm



Floor Lamp

962

Rechargeable

1060 mm

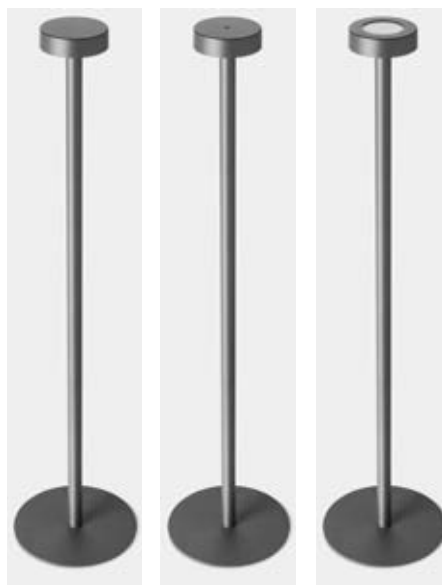

Plug&Play

1800 mm

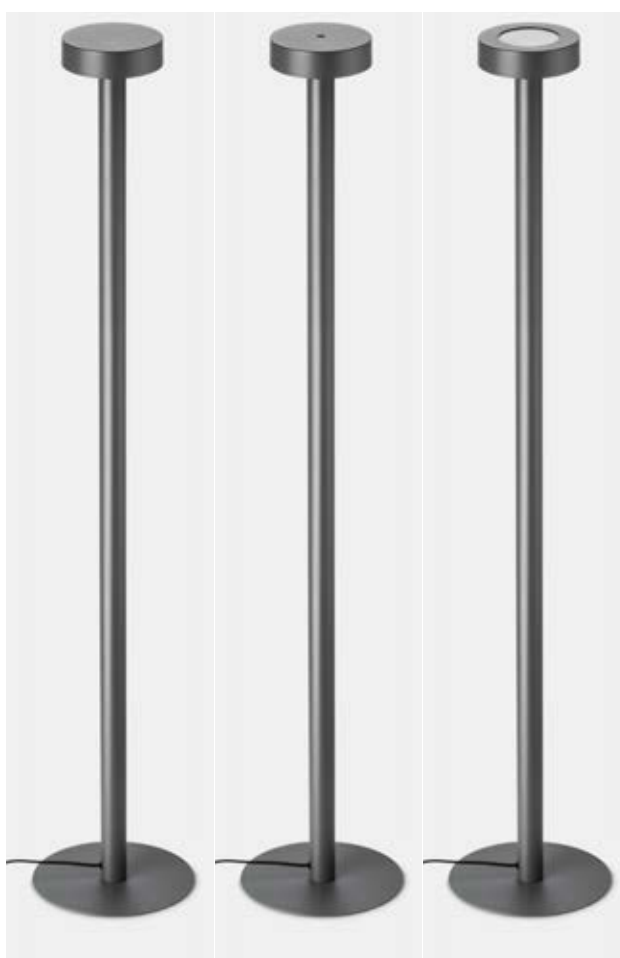

○ ● ● ● ● ● ●  
14 60 34 DL E3 J6 Z5

**Bollard**  
**784**

**Lampost**  
**789**

**Fixed**

500 mm



900 mm



**Fixed**

2300 mm

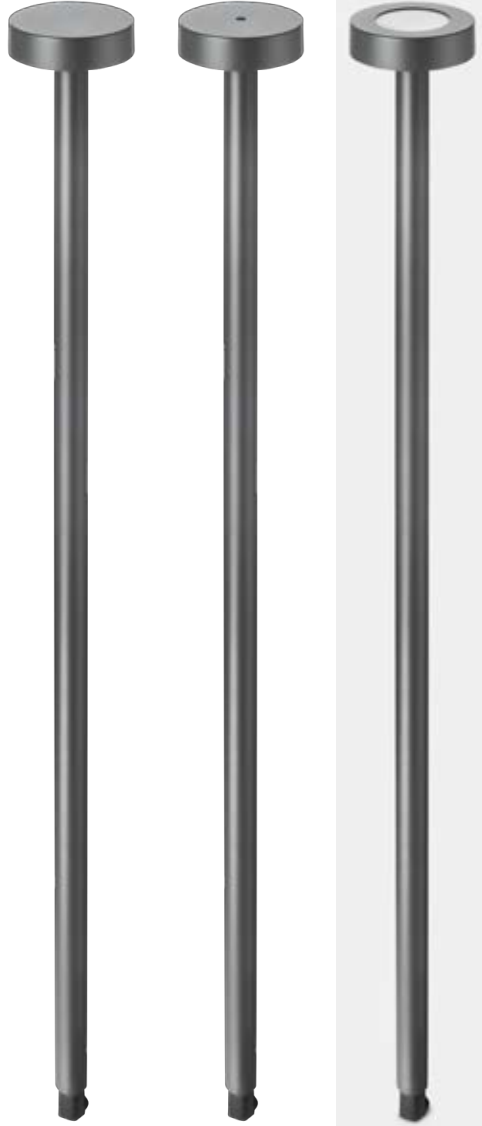









Opciones de luz en la parte superior del cabezal:  
punto de señalización, nula contaminación  
lumínica y suave luz hacia arriba.

Opções de luz na parte superior da  
cabeça: ponto de sinalização, poluição  
lumínica nula e luz suave para cima.



2700K



3000K



4000K



Switch CCT integrado que permite cambiar la temperatura de color según necesidad del espacio.  
Switch CCT integrado que permite alterar a temperatura da cor de acordo com as necessidades do espaço.



Difusor antivandálico IK10  
Difusor antivandalismo IK10

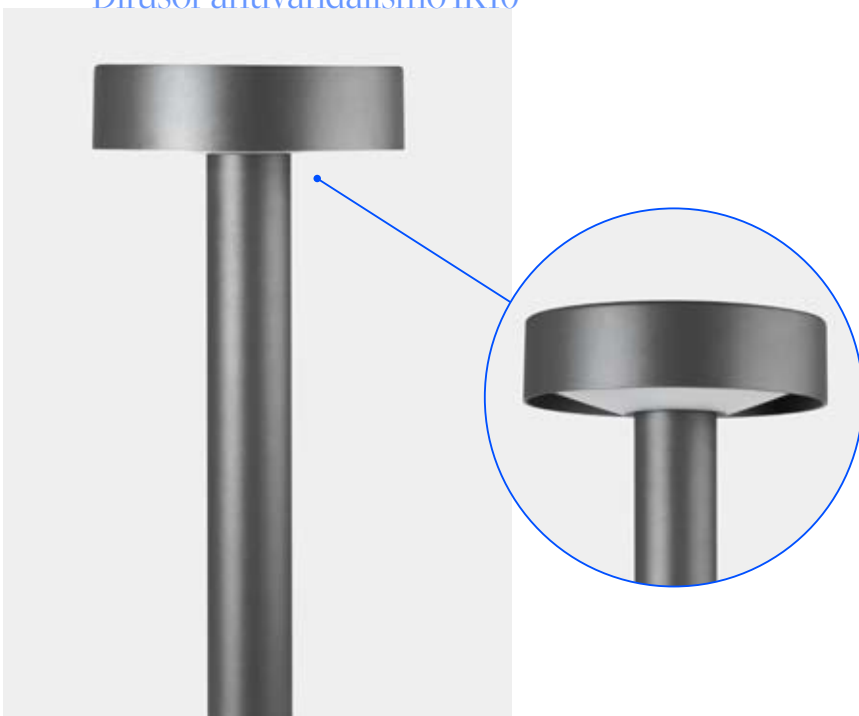



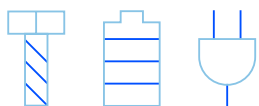

Tres opciones de alimentación:

Fija, portátil con batería y portátil con cable y enchufe.

Três opções de alimentação:

Fixa, portátil com bateria e portátil com cabo e ficha.





# Rack

Designed by Luca Turrini



+ Rack



No es fácil encontrar luminarias decorativas con altas prestaciones, como IP66, regulación DALI, eficiencia BREEAM o con un tratamiento especial para resistir en atmósferas marinas. Rack ha sido minuciosamente desarrollada para iluminar proyectos en los que la fiabilidad de la luminaria es tan importante como su función decorativa.

Não é fácil encontrar luminárias decorativas com altas prestações, como IP66, regulação DALI, eficiência BREEAM ou com um tratamento especial para resistir a atmosferas marinhas. Rack foi cuidadosamente desenvolvido para iluminar projetos onde a fiabilidade da luminária é tão importante como a sua função decorativa.

Máxima flexibilidad para una mejor adaptación  
Máxima flexibilidade para uma melhor adaptação



14

34

DL

E3

J6

Z5

60









Rechargeable

Plug&Play

Bollard

Wall Fixtures

958

958

958

910

100 × 100 × 270 mm

150 × 150 × 160 mm



150 × 150 × 300 mm



260 × 260 × 300 mm



150 × 150 × 700 mm



260 × 260 × 900 mm



○ ● ● ● ● ● ● ●  
14 60 34 DL E3 J6 Z5



Fuente de luz LED  
Fonte de luz LED

Accesorio difusor esférico  
Acessório difusor esférico



Instalaciones  
Instalações

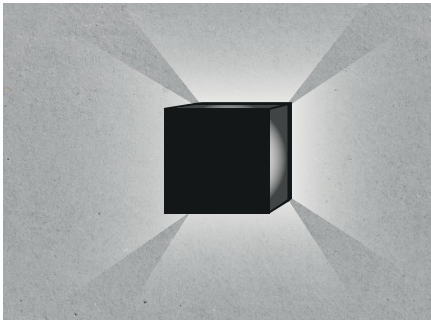

Aplique  
Aplique



Portátil  
Portátil

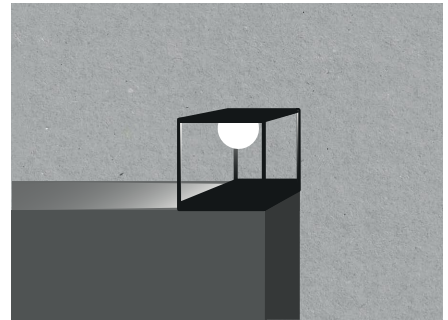

Sobremuro  
De mesa

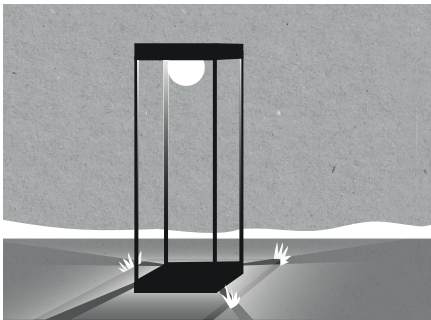

Baliza  
Baliza

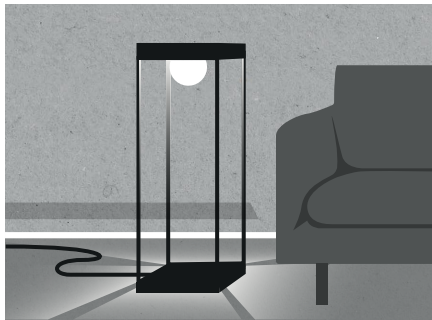

Pie de salón  
De pé

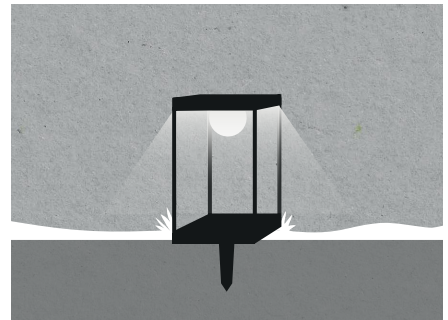

Portátil con estaca  
Portátil com estaca



Rack es una colección versátil que permite crear múltiples combinaciones  
 Rack é uma coleção versátil que permite criar múltiplas combinações

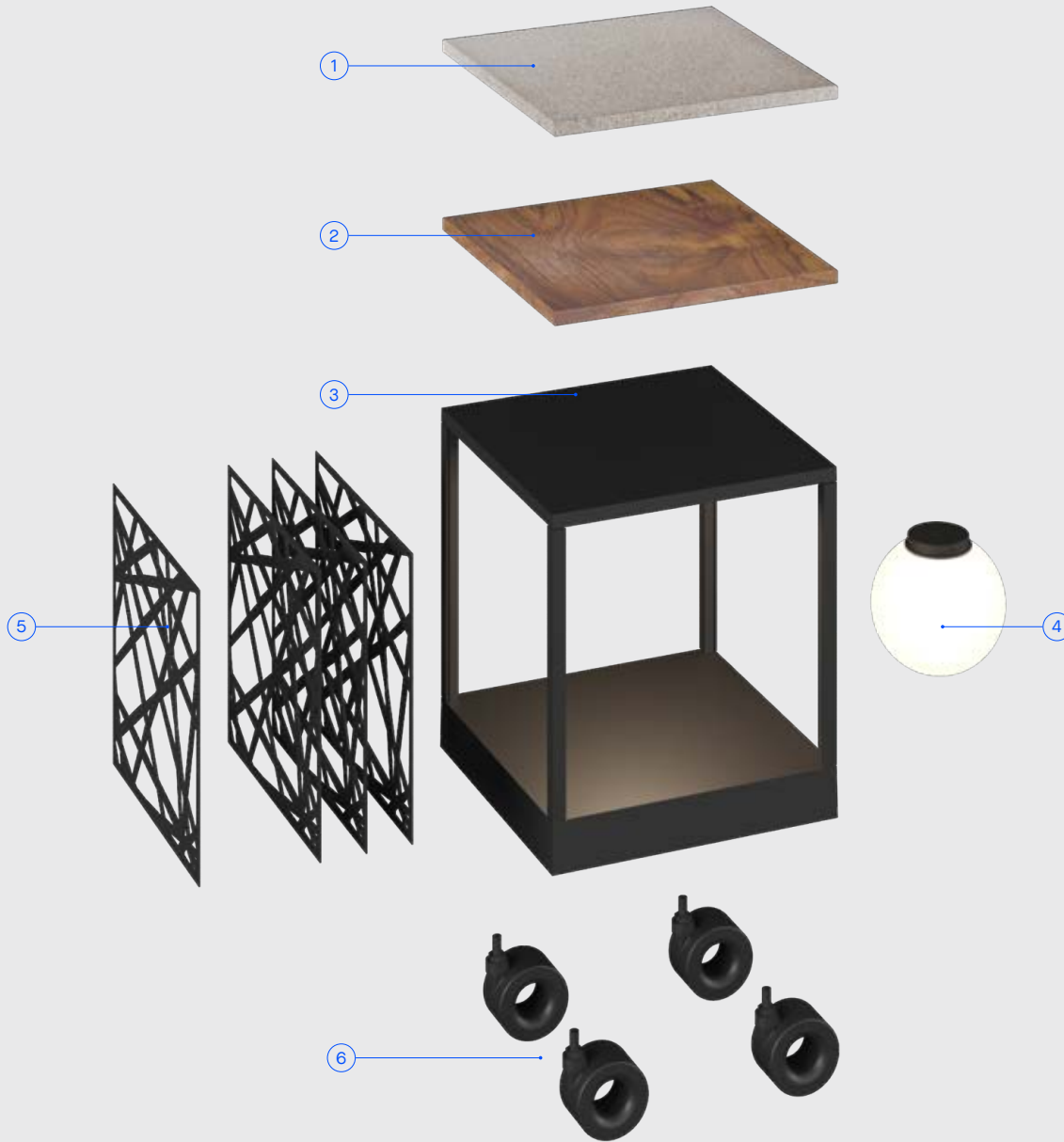

**Acabados superiores**  
**Acabamentos superiores**

- ① Tapa cemento  
Tampa cimento
- ② Tapa madera  
Tampa madeira
- ③ Sin tapa  
Sem tampa

**Accesorios opcionales**  
**Acessórios opcionais**

- ④ Difusor esférico  
Difusor esférico
- ⑤ Set de rejilla decorativa\*  
Set de grelha decorativa\*
- ⑥ Ruedas\*\*  
Rodas\*\*

**Acabados estructura**  
**Acabamentos estrutura**



\*Disponible con los colores de los acabados de estructura.  
 \*Disponível com as cores dos acabamentos da estrutura.  
 \*\*Sólo disponible para los modelos 260×260×300 mm y 260×260×900 mm.  
 \*\*Apenas disponível para os modelos 260×260×300 mm e 260×260×900 mm.

Un diseño que juega con  
distintos efectos de luz  
Um design que tem  
efeitos de luz



2700K

3000K

4000K





## Smart



Mediante la funcionalidad Smart se puede conseguir un ahorro energético gracias a a la gestión de luminarias punto a punto, por grupos o escenas, un control por ocupación y programaciones horarias, entre otras.

Através da funcionalidade Smart pode-se conseguir uma poupança energética graças à gestão de luminárias ponto a ponto, por grupos ou cenas, um controlo de ocupação e programações horárias, entre outras.

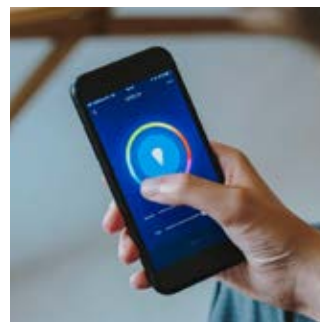

Ejemplo de aplicación con control vía Bluetooth Casambi. También disponible con el protocolo DALI2.  
Exemplo de aplicação com controlo via Bluetooth Casambi. Também disponível com o protocolo DALI2.

Acabados con materiales nobles de calidad  
Acabamentos com materiais nobres de qualidade



Ruedas diseñadas por Philippe Stark  
Rodas projetadas por Philippe Stark

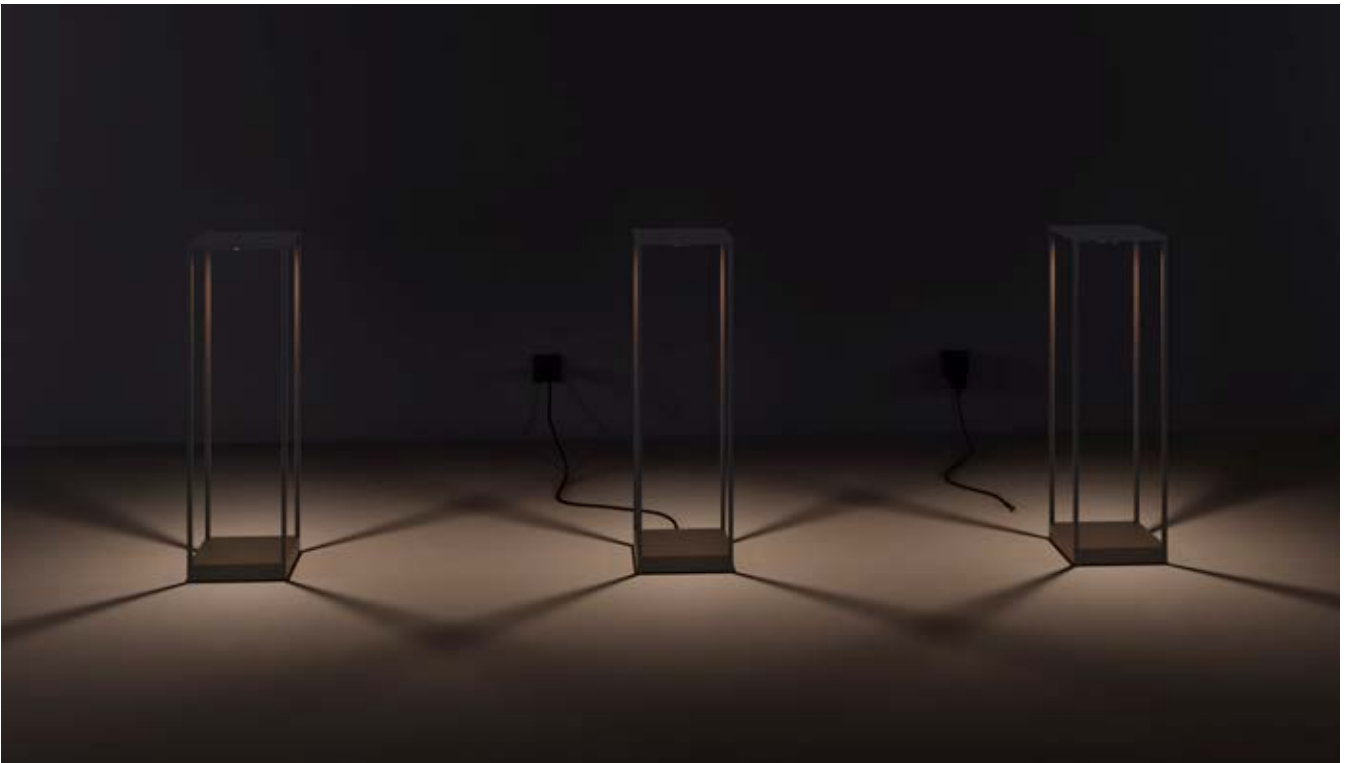

Tres opciones de alimentación:  
Fija, portátil con batería y portátil con cable y enchufe.  
Três opções de alimentação:  
Fixa, portátil com bateria e portátil com cabo e ficha.



# Sistemas Lineales

# Sistemas Lineares

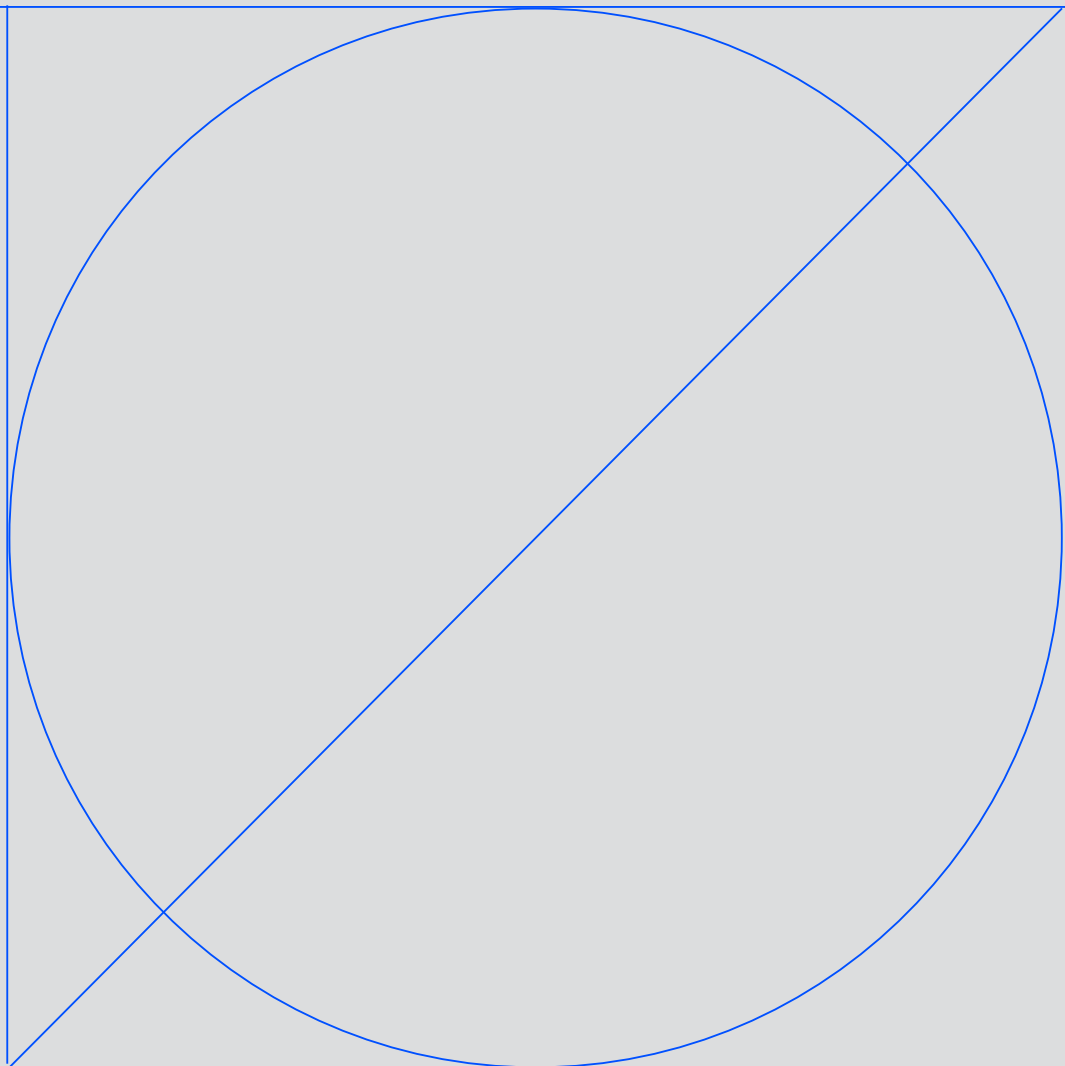
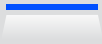

Taglio

518

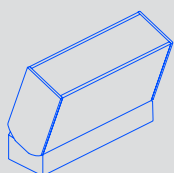

Verde

572

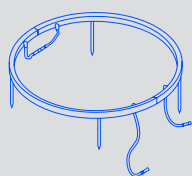

Convert

582

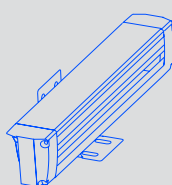

Mex

586

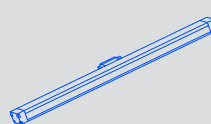

Cube Linear

594

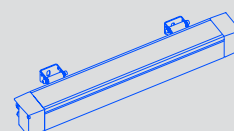

# Taglio

Designed by LedsC4 Architectural



+ Taglio

## Iluminación lineal integrada en la arquitectura

## Iluminação linear integrada na arquitetura

Taglio es una colección de iluminación lineal que enfatiza espacios arquitectónicos, crea composiciones y efectos de luz en suelos, techos y paredes. Su posibilidad de concatenación infinita la ha convertido en el máximo exponente de la integración arquitectónica en espacios exteriores.

Taglio é uma coleção de iluminação linear que enfatiza espaços arquitetônicos, cria composições e efeitos de luz no chão, tetos e paredes. A sua possibilidade de concatenação infinita converteu-a no máximo expoente da integração arquitetônica em espaços exteriores.

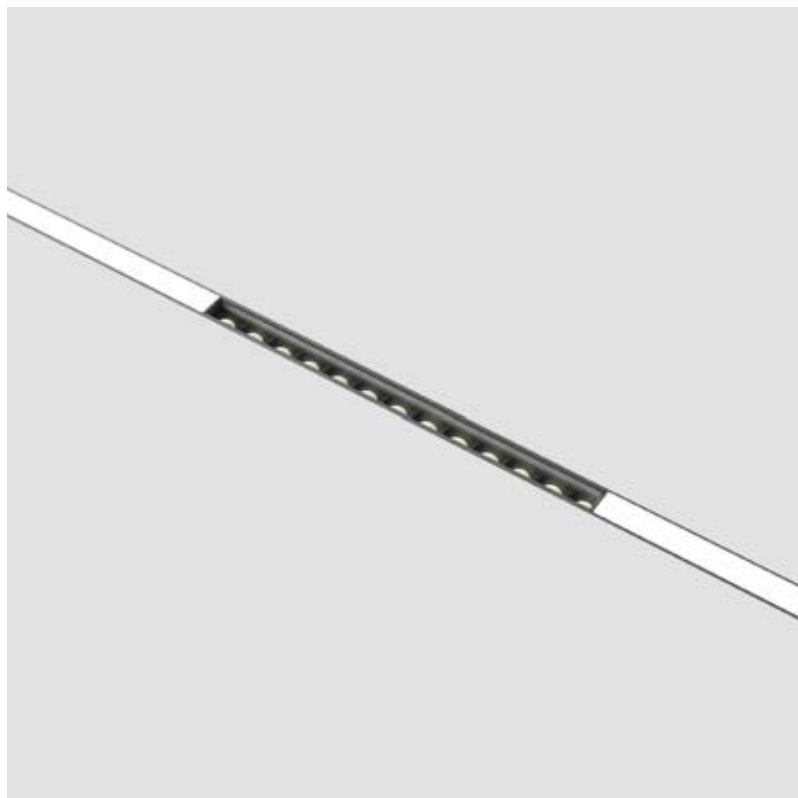

Taglio Opal



Taglio Optics



Taglio Indirect



14



34



DL



E3



J6



Z5



60





Taglio Direct Fix

524

Opal

111 × 35 mm



504 × 35 mm



1004 × 35 mm

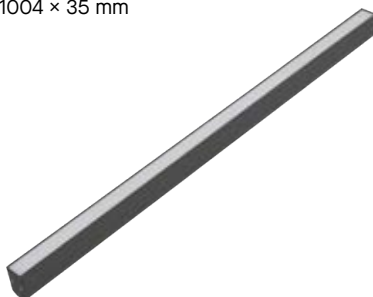

Taglio Direct Adjustable

534

111 × 35 mm



504 × 35 mm



1004 × 35 mm



Optics

111 × 35 mm



504 × 35 mm

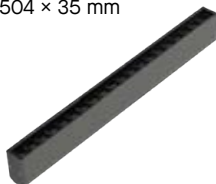

1004 × 35 mm



111 × 35 mm



504 × 35 mm

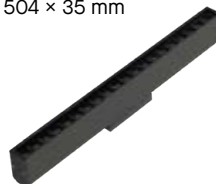

1004 × 35 mm



Opal: 1.2 W -15.4 W. Optics: 4-38 W  
3000K / 4000K / RGB



GL (Opal)

M (Optics)

○ ● ● ● ● ● ● ●  
14 60 34 DL E3 J6 Z5



M: Medium (23°) GL: General Light

Taglio Direct Wall

546

Taglio Direct Recessed

556

Taglio Indirect

568

Opal

111 x 48 mm



111 x 65 mm



504 x 48 mm



504 x 65 mm

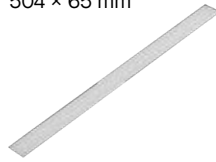

1004 x 48 mm



1004 x 65 mm



1000 x 60 mm



Optics

111 x 48 mm



111 x 65 mm



504 x 48 mm



504 x 65 mm

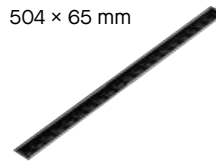

1004 x 48 mm

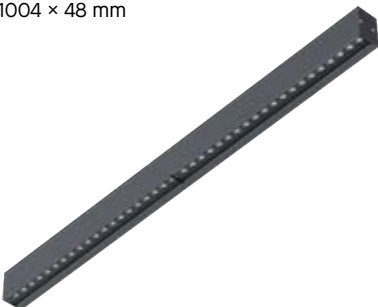

1004 x 65 mm

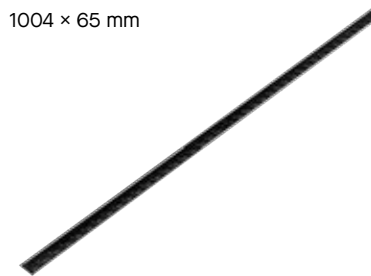

Opal: 1.2 W -15.4 W. Optics: 4-38 W  
3000K / 4000K / RGB

9.6 W  
3000K / 4000K / RGB



GL (Opal)

M (Optics)

14 60 34 DL E3 J6 Z5

14 60 34 DL E3 J6 Z5



# Instalaciones

## Instalações

### Direct Fix

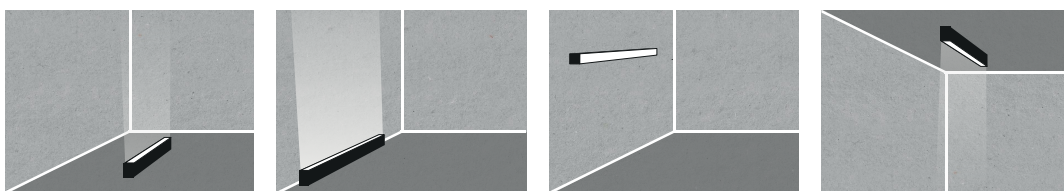

### Direct Adjustable

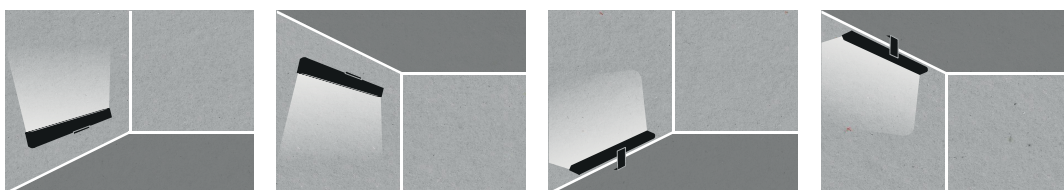

### Direct Wall

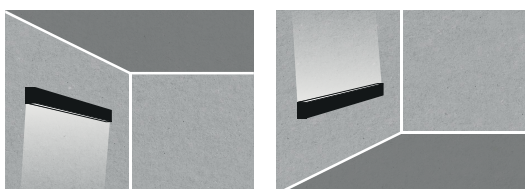

### Direct Recessed

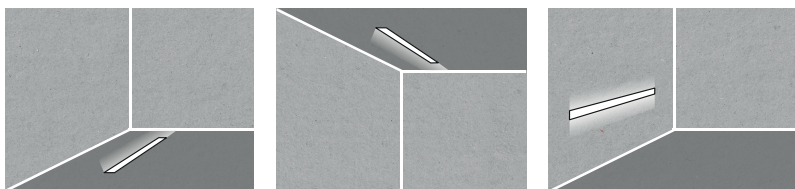

### Indirect

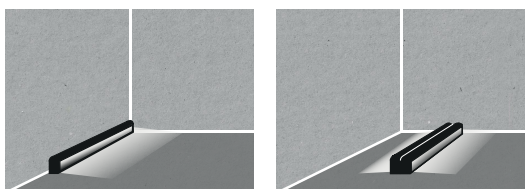

Fácil instalación  
Fácil instalação



# Tipos de iluminación

## Tipos de iluminação

### Iluminación general

#### Iluminação geral

Opal

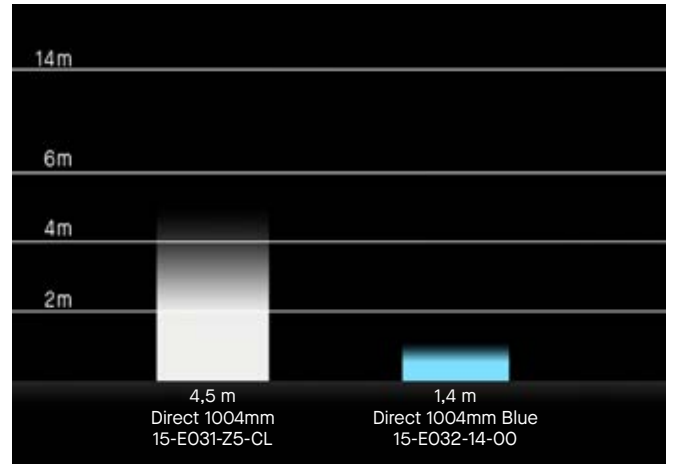

### Iluminación focalizada

#### Iluminação focalizada

Optics

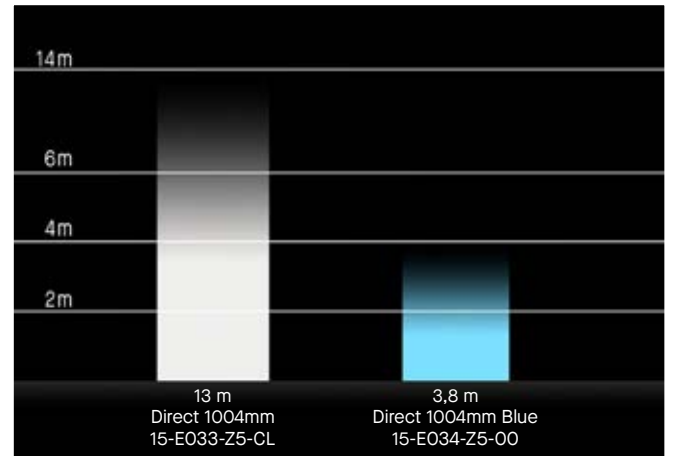

### Iluminación ambiental

#### Iluminação ambiental

Indirect



# Taglio Direct Fix



Iluminación directa  
de superficie  
Iluminación directa  
de superficie

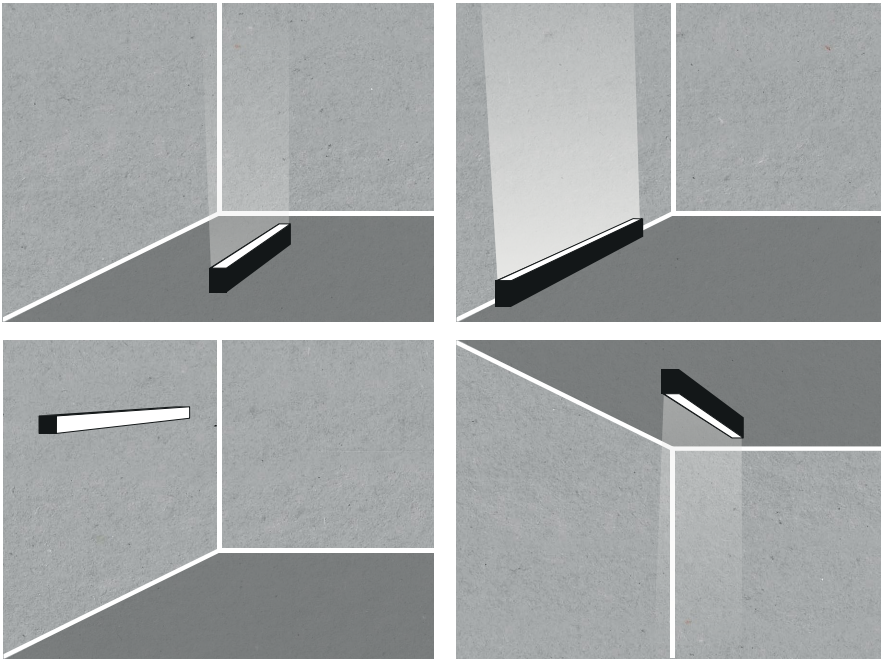

Taglio Opal

Taglio Optics



14



34



DL



E3

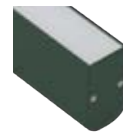

J6

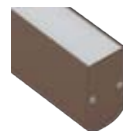

Z5

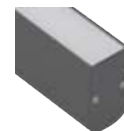

60





# Taglio

## Direct Surface Fix

BODY MAT  
AL

DIF MAT  
PMMA



50000h  
L80 B20

### Taglio Direct Surface Fix Opal 111mm



IP  
66

IK  
10

UGR  
<16

0.15 m



SEA SIDE  
SUITABLE



(SC)

Z5\* 14\* 60\* 34\* J6\* E3\* DL\*

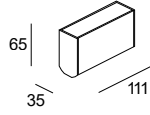
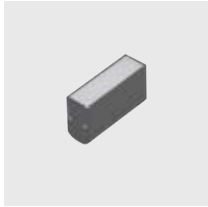

LED						24VDC	
K	CRI	W	Real Lm	Optics	Code		
3000	80	1.5	80	114°	15-E051	Z5 J6 E3 - DL - CL 14 60 34	
4000	80	1.5	85	114°	15-E051	Z5 J6 E3 - DL - CM 14 60 34	
RGB		1.2	21	114°	15-E052	Z5 J6 E3 - DL - 00 14 60 34	

**Taglio Direct Surface Fix Opal**  
**504mm**

NEW
IP 66
IK 10
UGR <16
0.15 m
SEA SIDE SUITABLE
LED
(SC)

● ○ ● ● ● ● ● ●  
 Z5\* 14\* 60\* 34\* J6\* E3\* DL\*

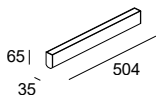

LED						24VDC	
K	CRI	W	Real Lm	Optics	Code		
3000	80	7.4	505	112°	15-E056	Z5	
						J6	
						E3	
						- DL - CL	
						14	
						60	
						34	
4000	80	7.4	541	112°	15-E056	Z5	
						J6	
						E3	
						- DL - CM	
						14	
						60	
						34	
RGB		7.8	104	113°	15-E057	Z5	
						J6	
						E3	
						- DL - 00	
						14	
						60	
						34	

\* Consulte condiciones y plazos de entrega a nuestro equipo comercial.  
 \* Consultar a nossa equipa comercial para informações sobre as condições e os prazos de entrega.

**Taglio Direct Surface Fix Opal**  
1004mm



Z5\* 14\* 60\* 34\* J6\* E3\* DL\*

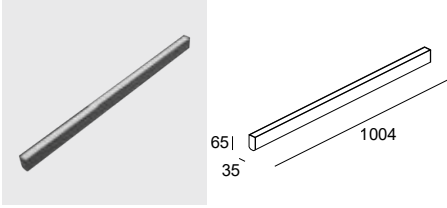

LED							24VDC	
K	CRI	W	Real Lm	Optics	Code			
3000	80	14.7	1092	114°	15-E060	Z5	J6	E3
						- DL - CL	14	60
						34		
4000	80	14.7	1169	114°	15-E060	Z5	J6	E3
						- DL - CM	14	60
						34		
RGB		15.6	207	113°	15-E061	Z5	J6	E3
						- DL - 00	14	60
						34		

**Taglio Direct Surface Fix Optics**  
111mm



Z5\* 14\* 60\* 34\* J6\* E3\* DL\*

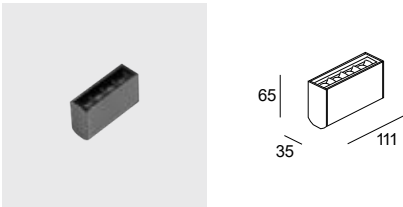

LED							24VDC	
K	CRI	W	Real Lm	Optics	Code			
3000	80	4	249	23°	15-E054	Z5	J6	E3
						- DL - CL	14	60
						34		
4000	80	4	249	23°	15-E054	Z5	J6	E3
						- DL - CM	14	60
						34		
RGB		3.7	91	21°	15-E055	Z5	J6	E3
						- DL - 00	14	60
						34		

\* Consulte condiciones y plazos de entrega a nuestro equipo comercial.  
\* Consultar a nossa equipa comercial para informações sobre as condições e os prazos de entrega.

## Taglio Direct Surface Fix Optics 504mm



Z5\* 14\* 60\* 34\* J6\* E3\* DL\*

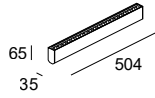

LED						24VDC
K	CRI	W	Real Lm	Optics	Code	
3000	80	19	1182	23°	15-E058	Z5 J6 E3 - DL - CL 14 60 34
4000	80	19	1182	23°	15-E058	Z5 J6 E3 - DL - CM 14 60 34
RGB		20	460	22°	15-E059	Z5 J6 E3 - DL - 00 14 60 34

## Taglio Direct Surface Fix Optics 1004mm

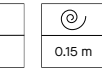

Z5\* 14\* 60\* 34\* J6\* E3\* DL\*

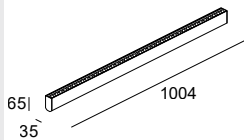

LED						24VDC
K	CRI	W	Real Lm	Optics	Code	
3000	80	38	2364	23°	15-E062	Z5 J6 E3 - DL - CL 14 60 34
4000	80	38	2364	23°	15-E062	Z5 J6 E3 - DL - CM 14 60 34
RGB		40	919	22°	15-E063	Z5 J6 E3 - DL - 00 14 60 34

\* Consulte condiciones y plazos de entrega a nuestro equipo comercial.  
\* Consultar a nossa equipa comercial para informações sobre as condições e os prazos de entrega.



Taglio Direct  
Surface Fix Opal  
111mm



Taglio Direct  
Surface Fix Opal  
111mm RGB



Taglio Direct  
Surface Fix Opal  
504mm



**Fuentes de alimentación**  
Fontes de alimentação

P. 1166



ON-OFF  
IP20

-

**71-6343-00-00**   
Min.15 - Max.75

-

ON-OFF  
IP67

**71-E158-00-00**   
Min.1 - Max.16

**71-E158-00-00**   
Min.1 - Max.16

**71-E159-00-00**   
Min.1 - Max.7



DALI2  
IP67

**71-E098-00-00**   
Min.1 - Max.30

-

**71-E098-00-00**   
Min.1 - Max.7



Fuente de alimentación estanca con conectores IP67  
Fonte de alimentação estanque com conectores IP67

**71-E101-05-05**   
Min.1 - Max.13

-

**71-E101-05-05**   
Min.1 - Max.2

**Controladores**  
Controladores

P. 1166



CASAMBI  
IP20

-

**71-8050-00-00**   
Min.10 - Max.28

-



CASAMBI  
IP67

**71-A242-00-00**

-

**71-A242-00-00**



Controlador DMX  
Controlador DMX

-

**71-3493-00-00**   
Min.10 - Max.28

-

**Accesorios de fijación**  
Acessórios de fixação



Estaca de 302mm  
Estaca de 302 mm

**71-9998-05-05**

**71-9998-05-05**

**71-9998-05-05**



Estaca de 235mm  
Estaca de 235 mm

**71-9997-05-05**

**71-9997-05-05**

**71-9997-05-05**

Taglio Direct  
Surface Fix Opal  
504mm RGB



Taglio Direct  
Surface Fix Opal  
1004mm



Taglio Direct  
Surface Fix Opal  
1004mm RGB



## Fuentes de alimentación Fontes de alimentação

P. 1166

	ON-OFF IP20	<b>71-6343-00-00</b>	-	<b>71-6343-00-00</b>
		Min.1 - Max.17		Min.1 - Max.9
	ON-OFF IP67	<b>71-E159-00-00</b>	<b>71-6345-00-00</b>	<b>71-6345-00-00</b>
		Min.1 - Max.7	Min.1 - Max.14	Min.1 - Max.14
	DALI2 IP67	-	<b>71-E099-00-00</b>	-
			Min.1 - Max.7	
	Fuente de alimentación estanca con conectores IP67 Fonte de alimentação estanque com conectores IP67	-	<b>71-E101-05-05</b>	-
			Min.1 - Max.1	

## Controladores Controladores

P. 1166

	CASAMBI IP20	<b>71-8050-00-00</b>	-	<b>71-8050-00-00</b>
		Min.1 - Max.16		Min.1 - Max.9
	CASAMBI IP67	-	<b>71-A242-00-00</b>	-
	Controlador DMX Controlador DMX	<b>71-3493-00-00</b>	-	<b>71-3493-00-00</b>
		Min.1 - Max.16		Min.1 - Max.9

## Accesorios de fijación Acessórios de fixação

	Estaca de 302mm Estaca de 302 mm	<b>71-9998-05-05</b>	<b>71-9998-05-05</b>	<b>71-9998-05-05</b>
	Estaca de 235mm Estaca de 235 mm	<b>71-9997-05-05</b>	<b>71-9997-05-05</b>	<b>71-9997-05-05</b>

Taglio Direct  
Surface Fix Optics  
111mm



Taglio Direct  
Surface Fix Optics  
111mm RGB



Taglio Direct  
Surface Fix Optics  
504mm



**Fuentes de alimentación**  
Fontes de alimentação

P. 1166



ON-OFF  
IP20

-

**71-6343-00-00**   
Min.5 - Max.36

-

ON-OFF  
IP67

**71-E159-00-00**   
Min.1 - Max.14

**71-E159-00-00**   
Min.1 - Max.14

**71-6345-00-00**   
Min.1 - Max.11



DALI2  
IP67

**71-E098-00-00**   
Min.1 - Max.14

-

**71-E099-00-00**   
Min.1 - Max.5



Fuente de alimentación estanca con conectores IP67  
Fonte de alimentação estanque com conectores IP67

**71-E101-05-05**   
Min.1 - Max.5

-

**71-E101-05-05**   
Min.1 - Max.1

**Controladores**  
Controladores

P. 1166



CASAMBI  
IP20

-

**71-8050-00-00**

-



CASAMBI  
IP67

**71-A242-00-00**

-

**71-A242-00-00**



Controlador DMX  
Controlador DMXz

-

**71-3493-00-00**   
Min.5 - Max.36

-

**Accesorios de fijación**  
Acessórios de fixação



Estaca de 302mm  
Estaca de 302 mm

**71-9998-05-05**

**71-9998-05-05**

**71-9998-05-05**



Estaca de 235mm  
Estaca de 235 mm

**71-9997-05-05**

**71-9997-05-05**

**71-9997-05-05**

Taglio Direct  
Surface Fix Optics  
504mm RGB



Taglio Direct  
Surface Fix Optics  
1004mm



Taglio Direct  
Surface Fix Optics  
1004mm RGB



## Fuentes de alimentación Fontes de alimentação

P. 1166

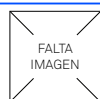

ON-OFF  
IP20

**71-6343-00-00**   
Min.1 - Max.7

-

**71-6343-00-00**   
Min.1 - Max.3

ON-OFF  
IP67

**71-6345-00-00**   
Min.1 - Max.11

**71-6345-00-00**   
Min.1 - Max.6

**71-6345-00-00**   
Min.1 - Max.6



DALI2  
IP67

-

**71-E099-00-00**   
Min.1 - Max.3

-



Fuente de alimentación estanca con conectores IP67  
Fonte de alimentação estanque com conectores IP67

-

-

-

## Controladores Controladores

P. 1166



CASAMBI  
IP20

**71-8050-00-00**   
Min.1 - Max.7

-

**71-8050-00-00**   
Min.1 - Max.3



CASAMBI  
IP67

-

**71-A242-00-00**

-



Controlador DMX  
Controlador DMX

**71-3493-00-00**   
Min.1 - Max.7

-

**71-3493-00-00**   
Min.1 - Max.3

## Accesorios de fijación Acessórios de fixação



Estaca de 302mm  
Estaca de 302 mm

**71-9998-05-05**

**71-9998-05-05**

**71-9998-05-05**



Estaca de 235mm  
Estaca de 235 mm

**71-9997-05-05**

**71-9997-05-05**

**71-9997-05-05**

# Taglio Direct Adjustable



Iluminación directa  
y orientable de  
superficie  
Iluminação direta  
e orientável de  
superfície



Taglio Opal con accesorio brazo  
Taglio Opal com acessório braço



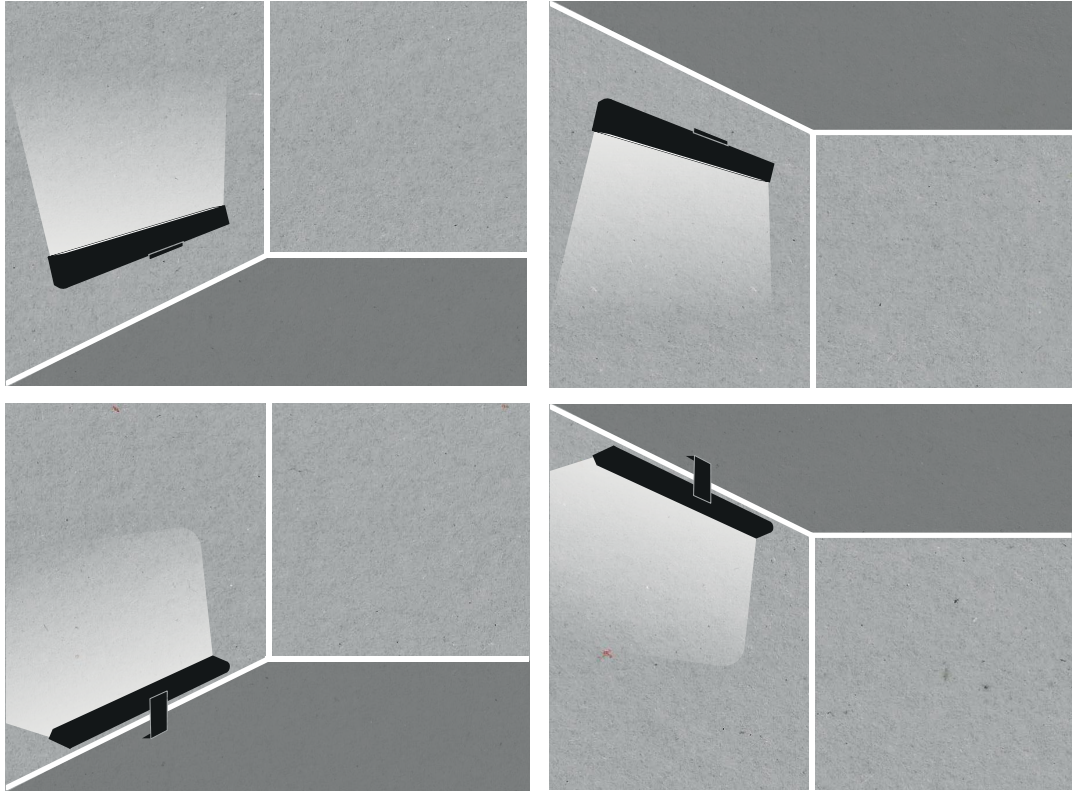

# Taglio

## Direct Surface Adjustable

BODY MAT  
AL

DIF MAT  
PMMA



50000h  
L80 B20

### Taglio Direct Surface Adjustable Opal 111mm

IP  
66

IK  
10

UGR  
<16

0.15 m



SEA SIDE  
SUITABLE

20°



(SC)

Z5\* 14\* 60\* 34\* J6\* E3\* DL\*

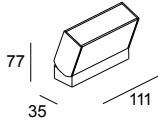

LED						24VDC	
K	CRI	W	Real Lm	Optics	Code		
3000	80	1.5	80	114°	15-E023	Z5 J6 E3 - DL - CL 14 60 34	
4000	80	1.5	85	114°	15-E023	Z5 J6 E3 - DL - CM 14 60 34	
RGB		1.2	19	114°	15-E024	Z5 J6 E3 - DL - 00 14 60 34	



**Taglio Direct Surface**  
**Adjustable Opal 504mm**

IP	IK	UGR			SEA SIDE SUITABLE			(SC)
66	10	<16	0.15 m			20°		

● ○ ● ● ● ● ● ●  
Z5\* 14\* 60\* 34\* J6\* E3\* DL\*

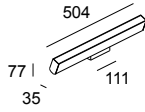

LED							24VDC
K	CRI	W	Real Lm	Optics	Code		
3000	80	7.4	505	112°	15-E027	Z5	
						J6	
						E3	
						- DL - CL	
						14	
						60	
						34	
4000	80	7.4	541	112°	15-E027	Z5	
						J6	
						E3	
						- DL - CM	
						14	
						60	
						34	
RGB		8.4	99	112°	15-E028	Z5	
						J6	
						E3	
						- DL - 00	
						14	
						60	
						34	

**Taglio Direct Surface**  
**Adjustable Opal 1000mm**

IP	IK	UGR			SEA SIDE SUITABLE			(SC)
66	10	<16	0.15 m			20°		

● ○ ● ● ● ● ● ●  
Z5\* 14\* 60\* 34\* J6\* E3\* DL\*

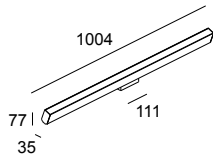

LED							24VDC
K	CRI	W	Real Lm	Optics	Code		
3000	80	14.7	1092	114°	15-E031	Z5	
						J6	
						E3	
						- DL - CL	
						14	
						60	
						34	
4000	80	14.7	1169	114°	15-E031	Z5	
						J6	
						E3	
						- DL - CM	
						14	
						60	
						34	
RGB		15.4	198	112°	15-E032	Z5	
						J6	
						E3	
						- DL - 00	
						14	
						60	
						34	

\* Consulte condiciones y plazos de entrega a nuestro equipo comercial.  
\* Consultar a nossa equipa comercial para informações sobre as condições e os prazos de entrega.

**Taglio Direct Surface**  
**Adjustable Optics 111mm**

IP 66	IK 10	UGR <10	0.15 m		SEA SIDE SUITABLE	20°		(SC)
----------	----------	------------	--------	--	----------------------	-----	--	------

Z5\* 14\* 60\* 34\* J6\* E3\* DL\*

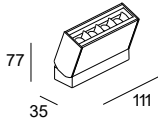

LED								24VDC
K	CRI	W	Real Lm	Optics	Code			
3000	80	4	249	23°	15-E025	Z5	J6	E3
						- DL - CL		
						14		
						60		
34								
4000	80	4	249	23°	15-E025	Z5	J6	E3
						- DL - CM		
						14		
						60		
34								
RGB		4	85	21°	15-E026	Z5	J6	E3
						- DL - 00		
						14		
						60		
34								

**Taglio Direct Surface**  
**Adjustable Optics 504mm**

IP 66	IK 06	UGR <10	0.15 m		SEA SIDE SUITABLE	20°		(SC)
----------	----------	------------	--------	--	----------------------	-----	--	------

Z5\* 14\* 60\* 34\* J6\* E3\* DL\*

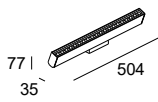

LED								24VDC
K	CRI	W	Real Lm	Optics	Code			
3000	80	19	1182	23°	15-E029	Z5	J6	E3
						- DL - CL		
						14		
						60		
34								
4000	80	19	1182	23°	15-E029	Z5	J6	E3
						- DL - CM		
						14		
						60		
34								
RGB		20	421	22°	15-E030	Z5	J6	E3
						- DL - 00		
						14		
						60		
34								

\* Consulte condiciones y plazos de entrega a nuestro equipo comercial.  
\* Consultar a nossa equipa comercial para informações sobre as condições e os prazos de entrega.

**Taglio Direct Surface**  
Adjustable Optics 1004mm

IP
66

IK
06

UGR
<10

⊙
0.15 m



SEA SIDE SUITABLE
----------------------

↻
20°



● ○ ● ● ● ● ● ●  
Z5\* 14\* 60\* 34\* J6\* E3\* DL\*

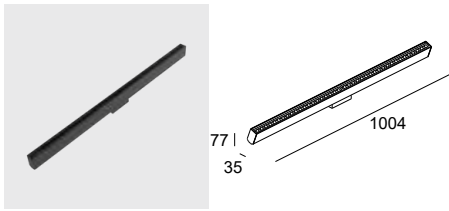

LED						24VDC	
K	CRI	W	Real Lm	Optics	Code		
3000	80	38	2364	23°	15-E033	Z5	
						J6	
						E3	
						- DL - CL	
						14	
						60	
						34	
4000	80	38	2364	23°	15-E033	Z5	
						J6	
						E3	
						- DL - CM	
						14	
						60	
						34	
RGB		40	842	22°	15-E034	Z5	
						J6	
						E3	
						- DL - 00	
						14	
						60	
						34	

OUTDOOR

SISTEMAS LINEALES | SISTEMAS LINEARES

\* Consulte condiciones y plazos de entrega a nuestro equipo comercial.  
\* Consultar a nossa equipa comercial para informações sobre as condições e os prazos de entrega.

Taglio Direct  
Surface Adjustable  
Opal 111mm



Taglio Direct  
Surface Adjustable  
Opal 111mm RGB



Taglio Direct  
Surface Adjustable  
Opal 504mm



**Fuentes de alimentación**  
Fontes de alimentação

P. 1166

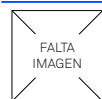

ON-OFF  
IP20

-

**71-6343-00-00**   
Min.15 - Max.75

-



ON-OFF  
IP67

**71-E158-00-00**   
Min.1 - Max.16

**71-E158-00-00**   
Min.1 - Max.16

**71-E159-00-00**   
Min.1 - Max.7



DALI2  
IP67

**71-E098-00-00**   
Min.1 - Max.30

-

**71-E098-00-00**   
Min.1 - Max.7



Fuente de alimentación estanca con conectores IP67  
Fonte de alimentação estanque com conectores IP67

**71-E101-05-05**   
Min.1 - Max.13

-

**71-E101-05-05**   
Min.1 - Max.2

**Controladores**  
Controladores

P. 1166



CASAMBI  
IP20

-

**71-8050-00-00**   
Min.10 - Max.28

-



CASAMBI  
IP67

**71-A242-00-00**

-

**71-A242-00-00**



Controlador DMX  
Controlador DMX

-

**71-3493-00-00**   
Min.10 - Max.28

-

Taglio Direct  
Surface Adjustable  
Opal 504mm RGB



Taglio Direct  
Surface Adjustable  
Opal 1000mm



Taglio Direct  
Surface Adjustable  
Opal 1000mm RGB



## Fuentes de alimentación Fontes de alimentação

P. 1166



ON-OFF  
IP20

**71-6343-00-00**   
Min.1 - Max.17

-

**71-6343-00-00**   
Min.1 - Max.9



ON-OFF  
IP67

**71-E159-00-00**   
Min.1 - Max.7

**71-6345-00-00**   
Min.1 - Max.14

**71-6345-00-00**   
Min.1 - Max.14



DALI2  
IP67

-

**71-E099-00-00**   
Min.1 - Max.7

-



Fuente de alimentación estanca con conectores IP67  
Fonte de alimentação estanque com conectores IP67

-

**71-E101-05-05**   
Min.1 - Max.1

-

## Controladores Controladores

P. 1166



CASAMBI  
IP20

**71-8050-00-00**   
Min.1 - Max.16

-

**71-8050-00-00**   
Min.1 - Max.9



CASAMBI  
IP67

-

**71-A242-00-00**

-



Controlador DMX  
Controlador DMX

**71-3493-00-00**   
Min.1 - Max.16

-

**71-3493-00-00**   
Min.1 - Max.9

Taglio Direct  
Surface Adjustable  
Optics 111mm



Taglio Direct  
Surface Adjustable  
Optics 111mm RGB



Taglio Direct  
Surface Adjustable  
Optics 504mm



**Fuentes de alimentación**  
Fontes de alimentação

P. 1166

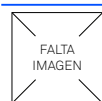

ON-OFF  
IP20

-

**71-6343-00-00**   
Min.5 - Max.36

-



ON-OFF  
IP67

**71-E159-00-00**   
Min.1 - Max.14

**71-E159-00-00**   
Min.1 - Max.14

**71-6345-00-00**   
Min.1 - Max.11



DALI2  
IP67

**71-E098-00-00**   
Min.1 - Max.14

-

**71-E099-00-00**   
Min.1 - Max.5



Fuente de alimentación estanca con conectores IP67  
Fonte de alimentação estanque com conectores IP67

**71-E101-05-05**   
Min.1 - Max.5

-

**71-E101-05-05**   
Min.1 - Max.1

**Controladores**  
Controladores

P. 1166



CASAMBI  
IP20

-

**71-8050-00-00**   
Min.5 - Max.36

-



CASAMBI  
IP67

**71-A242-00-00**

**71-A242-00-00**

**71-A242-00-00**



Controlador DMX  
Controlador DMX

-

**71-3493-00-00**   
Min.5 - Max.36

-

Taglio Direct  
Surface Adjustable  
Optics 504mm RGB



Taglio Direct  
Surface Adjustable  
Optics 1004mm



Taglio Direct  
Surface Adjustable  
Optics 1004mm RGB



## Fuentes de alimentación Fontes de alimentação

P. 1166

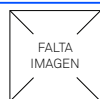

ON-OFF  
IP20

**71-6343-00-00**   
Min.1 - Max.7

-

**71-6343-00-00**   
Min.1 - Max.3



ON-OFF  
IP67

**71-6345-00-00**   
Min.1 - Max.11

**71-6345-00-00**   
Min.1 - Max.6

**71-6345-00-00**   
Min.1 - Max.6



DALI2  
IP67

-

**71-E099-00-00**   
Min.1 - Max.3

-



Fuente de alimentación estanca con conectores IP67  
Fonte de alimentação estanque com conectores IP67

-

-

-

## Controladores Controladores

P. 1166



CASAMBI  
IP20

**71-8050-00-00**   
Min.1 - Max.7

-

**71-8050-00-00**   
Min.1 - Max.3



CASAMBI  
IP67

-

**71-A242-00-00**

**71-A242-00-00**



Controlador DMX  
Controlador DMX

**71-3493-00-00**   
Min.1 - Max.7

-

**71-3493-00-00**   
Min.1 - Max.3



Taglio Direct Surface  
Adjustable Opal 111mm



Taglio Direct Surface  
Adjustable Opal 111mm RGB



Taglio Direct Surface  
Adjustable Opal 504mm



**Accesorios de fijación**  
Acessórios de fixação



Braço alargador 70mm  
Braço extensor 70mm

71-E359-Z5-00

71-E359-Z5-00

71-E359-Z5-00

71-E359-J6-00

71-E359-J6-00

71-E359-J6-00

71-E359-E3-00

71-E359-E3-00

71-E359-E3-00

71-E359-DL-00

71-E359-DL-00

71-E359-DL-00

71-E359-14-00

71-E359-14-00

71-E359-14-00

71-E359-60-00

71-E359-60-00

71-E359-60-00

71-E359-34-00

71-E359-34-00

71-E359-34-00



Braço alargador 140mm  
Braço extensor 140mm

71-E360-Z5-00

71-E360-Z5-00

71-E360-Z5-00

71-E360-J6-00

71-E360-J6-00

71-E360-J6-00

71-E360-E3-00

71-E360-E3-00

71-E360-E3-00

71-E360-DL-00

71-E360-DL-00

71-E360-DL-00

71-E360-14-00

71-E360-14-00

71-E360-14-00

71-E360-60-00

71-E360-60-00

71-E360-60-00

71-E360-34-00

71-E360-34-00

71-E360-34-00

Taglio Direct Surface  
Adjust. Opal 504mm RGB



Taglio Direct Surface  
Adjustable Opal 1000mm



Taglio Direct Surface  
Adjust. Opal 1000mm RGB



**Accesorios de fijación**  
Acessórios de fixação



Braço alargador 70mm  
Braço extensor 70mm

71-E359-Z5-00

71-E359-Z5-00

71-E359-Z5-00

71-E359-J6-00

71-E359-J6-00

71-E359-J6-00

71-E359-E3-00

71-E359-E3-00

71-E359-E3-00

71-E359-DL-00

71-E359-DL-00

71-E359-DL-00

71-E359-14-00

71-E359-14-00

71-E359-14-00

71-E359-60-00

71-E359-60-00

71-E359-60-00

71-E359-34-00

71-E359-34-00

71-E359-34-00



Braço alargador 140mm  
Braço extensor 140mm

71-E360-Z5-00

71-E360-Z5-00

71-E360-Z5-00

71-E360-J6-00

71-E360-J6-00

71-E360-J6-00

71-E360-E3-00

71-E360-E3-00

71-E360-E3-00

71-E360-DL-00

71-E360-DL-00

71-E360-DL-00

71-E360-14-00

71-E360-14-00

71-E360-14-00

71-E360-60-00

71-E360-60-00

71-E360-60-00

71-E360-34-00

71-E360-34-00

71-E360-34-00

Taglio Direct Surface  
Adjustable Optics 111mm



Taglio Direct Surface Adjus.  
Optics 111mm RGB



Taglio Direct Surface  
Adjustable Optics 504mm



**Accesorios de fijación**  
Acessórios de fixação



Brazo alargador 70mm  
Braço extensor 70mm

71-E359-Z5-00

71-E359-Z5-00

71-E359-Z5-00

71-E359-J6-00

71-E359-J6-00

71-E359-J6-00

71-E359-E3-00

71-E359-E3-00

71-E359-E3-00

71-E359-DL-00

71-E359-DL-00

71-E359-DL-00

71-E359-14-00

71-E359-14-00

71-E359-14-00

71-E359-60-00

71-E359-60-00

71-E359-60-00

71-E359-34-00

71-E359-34-00

71-E359-34-00



Brazo alargador 140mm  
Braço extensor 140mm

71-E360-Z5-00

71-E360-Z5-00

71-E360-Z5-00

71-E360-J6-00

71-E360-J6-00

71-E360-J6-00

71-E360-E3-00

71-E360-E3-00

71-E360-E3-00

71-E360-DL-00

71-E360-DL-00

71-E360-DL-00

71-E360-14-00

71-E360-14-00

71-E360-14-00

71-E360-60-00

71-E360-60-00

71-E360-60-00

71-E360-34-00

71-E360-34-00

71-E360-34-00

Taglio Direct Surface  
Adjust. Optics 504mm RGB



Taglio Direct Surface  
Adjustable Optics 1004mm



Taglio Direct Surface  
Adjust. Optics 1004mm RGB



**Accesorios de fijación**  
Acessórios de fixação



Brazo alargador 70mm  
Braço extensor 70mm

71-E359-Z5-00

71-E359-Z5-00

71-E359-Z5-00

71-E359-J6-00

71-E359-J6-00

71-E359-J6-00

71-E359-E3-00

71-E359-E3-00

71-E359-E3-00

71-E359-DL-00

71-E359-DL-00

71-E359-DL-00

71-E359-14-00

71-E359-14-00

71-E359-14-00

71-E359-60-00

71-E359-60-00

71-E359-60-00

71-E359-34-00

71-E359-34-00

71-E359-34-00



Brazo alargador 140mm  
Braço extensor 140mm

71-E360-Z5-00

71-E360-Z5-00

71-E360-Z5-00

71-E360-J6-00

71-E360-J6-00

71-E360-J6-00

71-E360-E3-00

71-E360-E3-00

71-E360-E3-00

71-E360-DL-00

71-E360-DL-00

71-E360-DL-00

71-E360-14-00

71-E360-14-00

71-E360-14-00

71-E360-60-00

71-E360-60-00

71-E360-60-00

71-E360-34-00

71-E360-34-00

71-E360-34-00

# Taglio Direct Wall



Iluminación rasante  
en la pared  
Iluminação rasante  
na parede

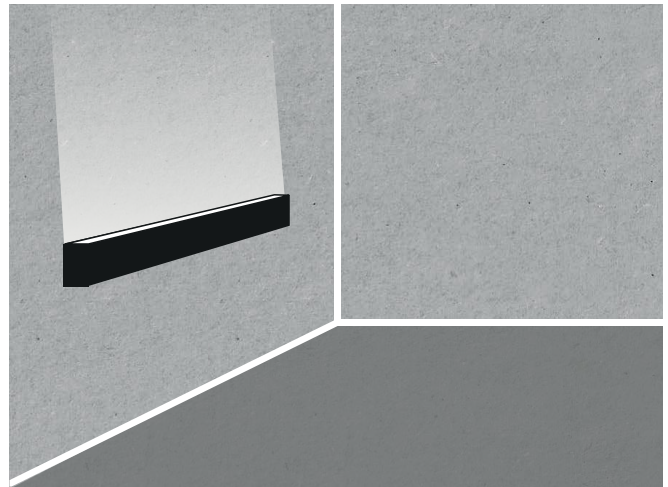
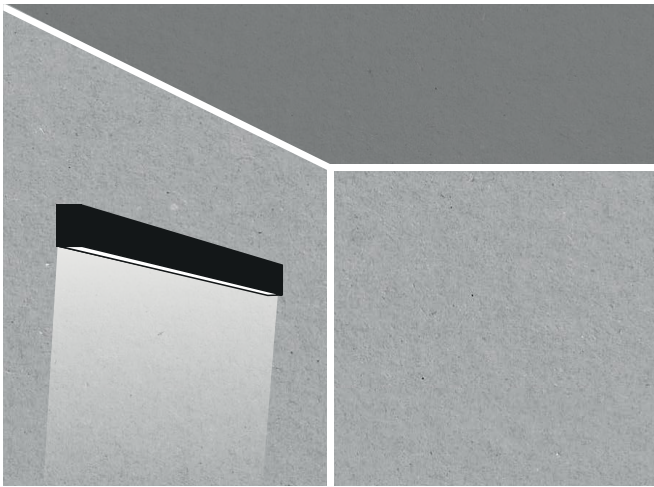

Taglio Opal



Taglio Optics



14



J6

34



Z5

DL



60

E3

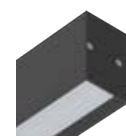
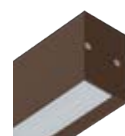
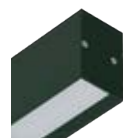



BODY MAT
AL

DIF MAT
PMMA



50000h
L80 B20

### Taglio Direct Wall Opal 111mm



IP
66

IK
10

UGR
<16

0.15 m
--------



Z5\* 14\* 60\* 34\* J6\* E3\* DL\*

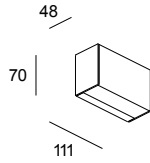

LED						24VDC	
K	CRI	W	Real Lm	Optics	Code		
3000	80	1.5	80	114°	<b>05-E113</b>	- DL - CL	Z5 J6 E3 14 60 34
4000	80	1.5	85	114°	<b>05-E113</b>	- DL - CM	Z5 J6 E3 14 60 34
RGB		1.2	21	114°	<b>05-E114</b>	- DL - 00	Z5 J6 E3 14 60 34

## Taglio Direct Wall Opal 504mm

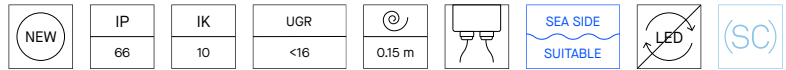

Z5\* 14\* 60\* 34\* J6\* E3\* DL\*

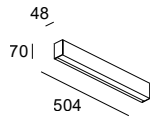

LED							24VDC		
K	CRI	W	Real Lm	Optics	Code	Z5	J6	E3	
3000	80	7.4	505	112°	05-E119	- DL - CL	14	60	34
4000	80	7.4	541	112°	05-E119	- DL - CM	14	60	34
RGB		7.8	104	113°	05-E120	- DL - 00	14	60	34

## Taglio Direct Wall Opal 1004mm

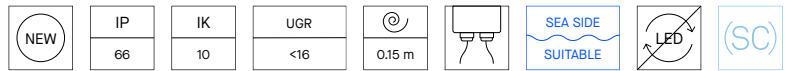

Z5\* 14\* 60\* 34\* J6\* E3\* DL\*

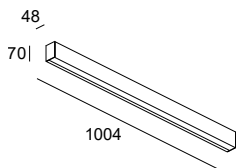

LED							24VDC		
K	CRI	W	Real Lm	Optics	Code	Z5	J6	E3	
3000	80	14.7	1092	114°	05-E123	- DL - CL	14	60	34
4000	80	14.7	1169	114°	05-E123	- DL - CM	14	60	34
RGB		15.6	207	113°	05-E124	- DL - 00	14	60	34

\* Consulte condiciones y plazos de entrega a nuestro equipo comercial.  
 \* Consultar a nossa equipa comercial para informações sobre as condições e os prazos de entrega.

Taglio Direct Wall Optics 111mm

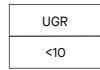

Z5\* 14\* 60\* 34\* J6\* E3\* DL\*

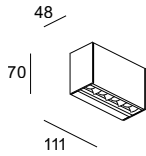

LED						24VDC	
K	CRI	W	Real Lm	Optics	Code		
3000	80	4	249	23°	05-E117	Z5 J6 E3 - DL - CL 14 60 34	
4000	80	4	249	23°	05-E117	Z5 J6 E3 - DL - CM 14 60 34	
RGB		3.7	91	21°	05-E118	Z5 J6 E3 - DL - 00 14 60 34	

Taglio Direct Wall Optics 504mm

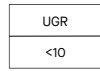

Z5\* 14\* 60\* 34\* J6\* E3\* DL\*

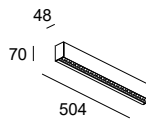

LED						24VDC	
K	CRI	W	Real Lm	Optics	Code		
3000	80	19	1182	23°	05-E121	Z5 J6 E3 - DL - CL 14 60 34	
4000	80	19	1182	23°	05-E121	Z5 J6 E3 - DL - CM 14 60 34	
RGB		20	460	22°	05-E122	Z5 J6 E3 - DL - 00 14 60 34	

\* Consulte condiciones y plazos de entrega a nuestro equipo comercial.  
 \* Consultar a nossa equipa comercial para informações sobre as condições e os prazos de entrega.



**Taglio Direct Wall Optics**  
1004mm

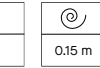

Z5\* 14\* 60\* 34\* J6\* E3\* DL\*

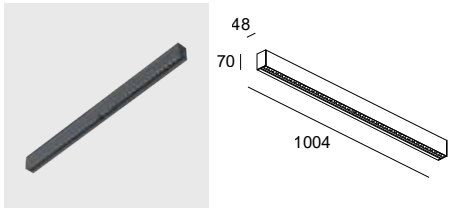

LED							24VDC	
K	CRI	W	Real Lm	Optics	Code			
3000	80	38	2364	23°	05-E125	Z5		
						J6		
						E3	- DL - CL	
						14	60	34
4000	80	38	2364	23°	05-E125	Z5		
						J6		
						E3	- DL - CM	
						14	60	34
RGB		40	919	22°	05-E126	Z5		
						J6		
						E3	- DL - 00	
						14	60	34

OUTDOOR

SISTEMAS LINEALES | SISTEMAS LINEARES

\* Consulte condiciones y plazos de entrega a nuestro equipo comercial.  
\* Consultar a nossa equipa comercial para informações sobre as condições e os prazos de entrega.

Taglio Direct Wall  
Opal 111mm



Taglio Direct Wall  
Opal 111mm RGB



Taglio Direct Wall  
Opal 504mm



**Fuentes de alimentación**  
Fontes de alimentação

P. 1166

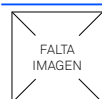

ON-OFF  
IP20

-

**71-6343-00-00**   
Min.15 - Max.75

-



ON-OFF  
IP67

**71-E158-00-00**   
Min.1 - Max.16

**71-E158-00-00**   
Min.1 - Max.16

**71-E159-00-00**   
Min.1 - Max.7



DALI2  
IP67

**71-E098-00-00**   
Min.1 - Max.30

-

**71-E098-00-00**   
Min.1 - Max.7



Fuente de alimentación estanca con conectores IP67  
Fonte de alimentação estanque com conectores IP67

**71-E101-05-05**   
Min.1 - Max.13

-

**71-E101-05-05**   
Min.1 - Max.2

**Controladores**  
Controladores

P. 1166



CASAMBI  
IP20

-

**71-8050-00-00**

-



CASAMBI  
IP67

**71-A242-00-00**

-

**71-A242-00-00**



Controlador DMX  
Controlador DMX

-

**71-3493-00-00**   
Min.10 - Max.28

-

Taglio Direct Wall  
Opal 504mm RGB



Taglio Direct Wall  
Opal 1004mm



Taglio Direct Wall  
Opal 1004mm RGB



## Fuentes de alimentación Fontes de alimentação

P. 1166



ON-OFF  
IP20

**71-6343-00-00**   
Min.1 - Max.17

-

**71-6343-00-00**   
Min.1 - Max.9



ON-OFF  
IP67

**71-E159-00-00**   
Min.1 - Max.7

**71-6345-00-00**   
Min.1 - Max.14

**71-6345-00-00**   
Min.1 - Max.14



DALI2  
IP67

-

**71-E099-00-00**   
Min.1 - Max.7

-



Fuente de alimentación estanca con conectores IP67  
Fonte de alimentação estanque com conectores IP67

-

**71-E101-05-05**   
Min.1 - Max.1

-

## Controladores Controladores

P. 1166



CASAMBI  
IP20

**71-8050-00-00**

-

**71-8050-00-00**



CASAMBI  
IP67

-

**71-A242-00-00**

-



Controlador DMX  
Controlador DMX

**71-3493-00-00**   
Min.1 - Max.16

-

**71-3493-00-00**   
Min.1 - Max.9

Taglio Direct Wall  
Optics 111mm

Taglio Direct Wall  
Optics 111mm RGB

Taglio Direct Wall  
Optics 504mm



**Fuentes de alimentación**  
Fontes de alimentação

P. 1166

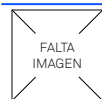

ON-OFF  
IP20

-

**71-6343-00-00**   
Min.5 - Max.36

-



ON-OFF  
IP67

**71-E159-00-00**   
Min.1 - Max.14

**71-E159-00-00**   
Min.1 - Max.14

**71-6345-00-00**   
Min.1 - Max.11



DALI2  
IP67

**71-E098-00-00**   
Min.1 - Max.14

-

**71-E099-00-00**   
Min.1 - Max.5



Fuente de alimentación estanca con conectores IP67  
Fonte de alimentação estanque com conectores IP67

**71-E101-05-05**   
Min.1 - Max.5

-

**71-E101-05-05**   
Min.1 - Max.1

**Controladores**  
Controladores

P. 1166



CASAMBI  
IP20

-

**71-8050-00-00**

-



CASAMBI  
IP67

**71-A242-00-00**

-

**71-A242-00-00**



Controlador DMX  
Controlador DMX

-

**71-3493-00-00**   
Min.5 - Max.36

-

Taglio Direct Wall  
Optics 504mm RGB

Taglio Direct Wall  
Optics 1004mm

Taglio Direct Wall  
Optics 1004mm  
RGB



**Fuentes de alimentación**  
**Fontes de alimentação**

P. 1166



ON-OFF  
IP20

**71-6343-00-00**   
Min.1 - Max.7

-

**71-6343-00-00**   
Min.1 - Max.3



ON-OFF  
IP67

**71-6345-00-00**   
Min.1 - Max.11

**71-6345-00-00**   
Min.1 - Max.6

**71-6345-00-00**   
Min.1 - Max.6



DALI2  
IP67

-

**71-E099-00-00**   
Min.1 - Max.3

-



Fuente de alimentación estanca con conectores IP67  
Fonte de alimentação estanque com conectores IP67

-

-

-

**Controladores**  
**Controladores**

P. 1166



CASAMBI  
IP20

**71-8050-00-00**

-

**71-8050-00-00**



CASAMBI  
IP67

-

**71-A242-00-00**

-



Controlador DMX  
Controlador DMX

**71-3493-00-00**   
Min.1 - Max.7

-

**71-3493-00-00**   
Min.1 - Max.3

# Taglio Recessed



Iluminación rasante  
Iluminação rasante

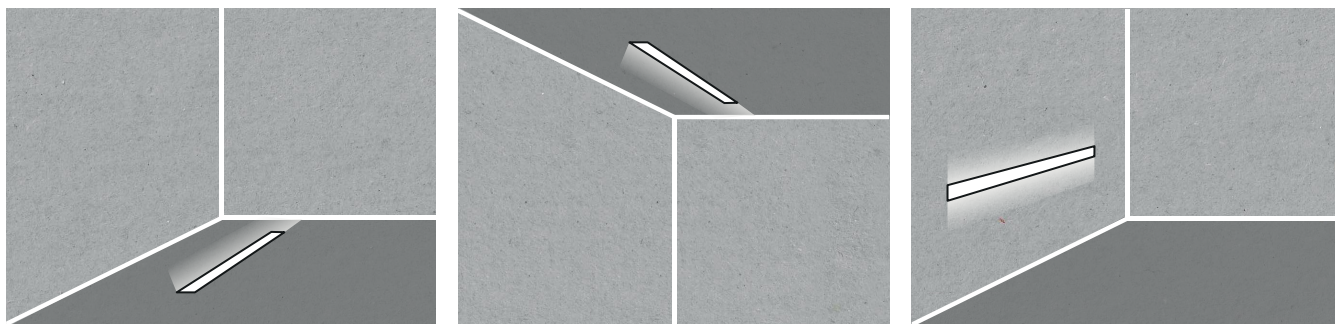

Taglio Opal

Taglio Optics



### Taglio Direct Recessed Opal 111mm

	IP 66	IK 10	UGR <16	 0.15 m		SEA SIDE SUITABLE			
--	----------	----------	------------	------------	--	----------------------	--	--	--

(SC)

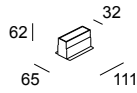

111x65

LED						24VDC
K	CRI	W	Real Lm	Optics	Code	
3000	80	1.5	80	114°	<b>55-E039 - M3 - CL</b>	
4000	80	1.5	85	114°	<b>55-E039 - M3 - CM</b>	
RGB		1.2	19	114°	<b>55-E040 - M3 - 00</b>	

M3

### Taglio Direct Recessed Opal 504mm

	IP 66	IK 10	UGR <16	 0.15 m		SEA SIDE SUITABLE			
--	----------	----------	------------	------------	--	----------------------	--	--	--

(SC)

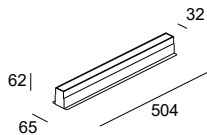

504x65

LED						24VDC
K	CRI	W	Real Lm	Optics	Code	
3000	80	7.4	505	112°	<b>55-E042 - M3 - CL</b>	
4000	80	7.4	541	112°	<b>55-E042 - M3 - CM</b>	
RGB		8.4	99	112°	<b>55-E043 - M3 - 00</b>	

M3

### Taglio Direct Recessed Opal 1004mm

IP 65	IK 10	UGR <19	BREEAM	 0.15 m		SEA SIDE SUITABLE			
----------	----------	------------	--------	------------	--	----------------------	--	--	--

(SC)

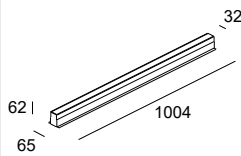

1004x65

LED						24VDC
K	CRI	W	Real Lm	Optics	Code	
3000	80	14.7	1092	114°	<b>55-E004 - M3 - CL</b>	
4000	80	14.7	1169	114°	<b>55-E004 - M3 - CM</b>	
RGB		15.4	800	128°	<b>55-E005 - M3 - 00</b>	

M3

### Taglio Direct Recessed Optics 111mm

	IP 66	IK 10	UGR <10	 0.15 m		SEA SIDE SUITABLE			
--	----------	----------	------------	------------	--	----------------------	--	--	--

(SC)

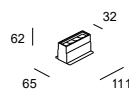

111x65

LED						24VDC
K	CRI	W	Real Lm	Optics	Code	
3000	80	4	249	23°	<b>55-E162 - 37 - CL</b>	
4000	80	4	261	23°	<b>55-E162 - 37 - CM</b>	
RGB		4	85	21°	<b>55-E041 - 37 - 00</b>	

37



**Taglio Direct Recessed Optics  
504mm**

NEW
IP 66
IK 06
UGR <10
1500 Kg
0.15 m
SEA SIDE SUITABLE
LED



37

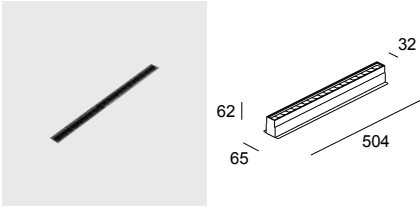

LED						24VDC
K	CRI	W	Real Lm	Optics	Code	
3000	80	19	1088	23°	<b>55-E163 - 37 - CL</b>	
4000	80	19	1140	23°	<b>55-E163 - 37 - CM</b>	
RGB		20	421	22°	<b>55-E050 - 37 - 00</b>	

504x65

**Taglio Direct Recessed Optics  
1004mm**

NEW
IP 66
IK 06
UGR <10
1500 Kg
0.15 m
SEA SIDE SUITABLE
LED



37

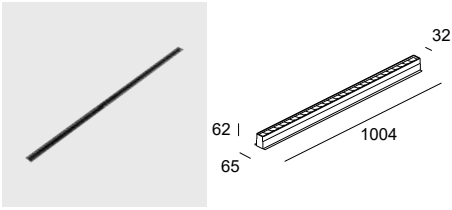

LED						24VDC
K	CRI	W	Real Lm	Optics	Code	
3000	80	38	2364	23°	<b>55-E051 - 37 - CL</b>	
4000	80	38	2364	23°	<b>55-E051 - 37 - CM</b>	
RGB		40	842	22°	<b>55-E052 - 37 - 00</b>	

1004x65



Taglio Direct  
Recessed Opal  
111mm



Taglio Direct  
Recessed Opal  
111mm RGB



Taglio Direct  
Recessed Opal  
504mm



**Fuentes de alimentación**  
Fontes de alimentação

P. 1166

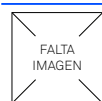

ON-OFF  
IP20

-

**71-6343-00-00**   
Min.15 - Max.75

-



ON-OFF  
IP67

**71-E158-00-00**   
Min.1 - Max.16

**71-E158-00-00**   
Min.1 - Max.16

**71-E159-00-00**   
Min.1 - Max.7



DALI2  
IP67

**71-E098-00-00**   
Min.1 - Max.30

-

**71-E098-00-00**   
Min.1 - Max.7



Fuente de alimentación estanca con conectores IP67  
Fonte de alimentação estanque com conectores IP67

**71-E101-05-05**   
Min.1 - Max.13

-

**71-E101-05-05**   
Min.1 - Max.2

**Controladores**  
Controladores

P. 1166



CASAMBI  
IP20

-

**71-8050-00-00**   
Min.10 - Max.28

-



CASAMBI  
IP67

**71-A242-00-00**

**71-A242-00-00**

**71-A242-00-00**



Controlador DMX  
Controlador DMX

-

**71-3493-00-00**   
Min.10 - Max.28

-

**Accesorios de fijación**  
Acessórios de fixação



Caja de empotrar  
Caixa de encastrar

242

242

242



Tapa protectora durante la instalación  
Tampa protetora durante a instalação

Included

Included

Included

**Accesorios de reparación**  
Acessórios de reparação



Kit de extracción módulo LED  
Kit de extração módulo LED

**71-E362-Z5-00**

**71-E362-Z5-00**

**71-E362-Z5-00**

Taglio Direct  
Recessed Opal  
504mm RGB



Taglio Direct  
Recessed Opal  
1004mm



Taglio Direct  
Recessed Opal  
1004mm RGB



## Fuentes de alimentación Fontes de alimentação

P. 1166



ON-OFF  
IP20

**71-6343-00-00**   
Min.1 - Max.17

-

**71-6343-00-00**   
Min.1 - Max.9



ON-OFF  
IP67

**71-E159-00-00**   
Min.1 - Max.7

**71-6345-00-00**   
Min.1 - Max.14

**71-6345-00-00**   
Min.1 - Max.14



DALI2  
IP67

-

**71-E099-00-00**   
Min.1 - Max.7

-



Fuente de alimentación estanca con conectores IP67  
Fonte de alimentação estanque com conectores IP67

-

**71-E101-05-05**   
Min.1 - Max.1

-

## Controladores Controladores

P. 1166



CASAMBI  
IP20

**71-8050-00-00**   
Min.1 - Max.16

-

**71-8050-00-00**



CASAMBI  
IP67

**71-A242-00-00**

**71-A242-00-00**

-



Controlador DMX  
Controlador DMX

**71-3493-00-00**   
Min.1 - Max.16

-

**71-3493-00-00**   
Min.1 - Max.9

## Accesorios de fijación Acessórios de fixação



Caja de empotrar  
Caixa de encastrar

242

242

Included



Tapa protectora durante la instalación  
Tampa protetora durante a instalação

Included

Included

Included

## Accesorios de reparación Acessórios de reparação



Kit de extracción módulo LED  
Kit de extração módulo LED

**71-E362-Z5-00**

**71-E362-Z5-00**

**71-E362-Z5-00**

Taglio Direct  
Recessed Optics  
111mm



Taglio Direct  
Recessed Optics  
111mm RGB



Taglio Direct  
Recessed Optics  
504mm



**Fuentes de alimentación**  
Fontes de alimentação

P. 1166



ON-OFF  
IP20

-

**71-6343-00-00**   
Min.5 - Max.36

-



ON-OFF  
IP67

**71-E159-00-00**   
Min.1 - Max.14

**71-E159-00-00**   
Min.1 - Max.14

**71-6345-00-00**   
Min.1 - Max.11



DALI2  
IP67

**71-E098-00-00**   
Min.1 - Max.14

-

**71-E099-00-00**   
Min.1 - Max.5



Fuente de alimentación estanca con conectores IP67  
Fonte de alimentação estanque com conectores IP67

**71-E101-05-05**   
Min.1 - Max.5

-

**71-E101-05-05**   
Min.1 - Max.1

**Controladores**  
Controladores

P. 1166



CASAMBI  
IP20

-

**71-8050-00-00**   
Min.5 - Max.36

-



CASAMBI  
IP67

**71-A242-00-00**

**71-A242-00-00**

**71-A242-00-00**



Controlador DMX  
Controlador DMX

-

**71-3493-00-00**   
Min.5 - Max.36

-

**Accesorios de fijación**  
Acessórios de fixação



Caja de empotrar  
Caixa de encastrar

Included

242

Included



Tapa protectora durante la instalación  
Tampa protetora durante a instalação

Included

Included

Included

**Accesorios de reparación**  
Acessórios de reparação



Kit de extracción módulo LED  
Kit de extração módulo LED

**71-E362-Z5-00**

**71-E362-Z5-00**

**71-E362-Z5-00**

Taglio Direct  
Recessed Optics  
504mm RGB



Taglio Direct  
Recessed Optics  
1004mm







Taglio Direct  
Recessed Optics  
1004mm RGB







## Fuentes de alimentación Fontes de alimentação

P. 1166



	ON-OFF IP20	<b>71-6343-00-00</b>  Min.1 - Max.7	-	<b>71-6343-00-00</b>  Min.1 - Max.3
	ON-OFF IP67	<b>71-6345-00-00</b>  Min.1 - Max.11	<b>71-6345-00-00</b>  Min.1 - Max.6	<b>71-6345-00-00</b>  Min.1 - Max.6
	DALI2 IP67	-	<b>71-E099-00-00</b>  Min.1 - Max.3	-
	Fuente de alimentación estanca con conectores IP67 Fonte de alimentação estanque com conectores IP67	-	-	-

## Controladores Controladores

P. 1166

	CASAMBI IP20	<b>71-8050-00-00</b>	-	<b>71-8050-00-00</b>
	CASAMBI IP67	-	<b>71-A242-00-00</b>	-
	Controlador DMX Controlador DMX	<b>71-3493-00-00</b>  Min.1 - Max.7	-	<b>71-3493-00-00</b>  Min.1 - Max.3

## Accesorios de fijación Acessórios de fixação

	Caja de empotrar Caixa de encastrar	Included	242	Included
	Tapa protectora durante la instalación Tampa protetora durante a instalação	Included	Included	Included

## Accesorios de reparación Acessórios de reparação

	Kit de extracción módulo LED Kit de extração módulo LED	<b>71-E362-Z5-00</b>	<b>71-E362-Z5-00</b>	<b>71-E362-Z5-00</b>
-------------------------------------------------------------------------------------	------------------------------------------------------------	----------------------	----------------------	----------------------

Taglio Direct  
Opal 111mmTaglio Direct  
Opal 111mm RGBTaglio Direct  
Opal 504mm**Accesorios de unión**  
**Acessórios de união**Placas para instalación concatenada  
Placas para instalação concatenada

Included

Included

Included

**Accesorios de conexión**  
**Acessórios de conexão**Cable con conectores estancos macho-hembra (1m)  
Cabo com conetores estanques macho-fêmea (1 m)

71-E034-00-00

-

71-E034-00-00

Cable con conectores estancos macho-hembra (5m)  
Cabo com conetores estanques macho-fêmea (5 m)

71-E004-00-00

-

71-E004-00-00

Cable RGB con conectores estancos macho-hembra (1m)  
Cabo RGB com conetores estanques macho-fêmea (1 m)

-

71-E071-00-00

-

Cable RGB con conectores estancos macho-hembra (5m)  
Cabo RGB com conetores estanques macho-fêmea (5 m)

-

71-E005-00-00

-

Conector IP67 (1 entrada + 1 salida) Ø 5,5 - 7,5mm, 3 polos  
Conetor IP67 (1 entrada + 1 saída) Ø 5,5 - 7,5 mm, 3 polos

71-E510-00-00

-

71-E510-00-00

Conector IP67 (1 entrada + 2 salidas) Ø 5,5 - 7,5mm, 3 polos  
Conetor IP67 (1 entrada + 2 saídas) Ø 5,5 - 7,5 mm, 3 polos

71-E511-00-00

-

71-E511-00-00

Conector IP68 (1 entrada + 1 salida) Ø 5,5 - 11,5mm, 4 polos  
Conetor IP68 (1 entrada + 1 saída) Ø 5,5 - 11,5 mm, 4 polos

71-E512-00-00

71-E512-00-00

71-E512-00-00

Conector IP68 (1 entrada + 2 salidas) Ø 5,5 - 11,5mm, 3 polos  
Conetor IP68 (1 entrada + 2 saídas) Ø 5,5 - 11,5 mm, 3 polos

71-E513-00-00

-

71-E513-00-00

Conector anticondensación IP68 (1 entrada + 1 salida) Ø 5,5 - 12mm, 4 polos  
Conetor anticondensação IP68 (1 entrada + 1 saída) Ø 5,5 - 12 mm, 4 polos

71-E112-00-00

71-E112-00-00

71-E112-00-00

Conector anticondensación IP68 (1 entrada + 3 salidas) Ø 5,5 - 12mm, 4 polos  
Conetor anticondensação IP68 (1 entrada + 3 saídas) Ø 5,5 - 12 mm, 4 polos

71-E122-00-00

71-E122-00-00

71-E122-00-00



Taglio Direct  
Opal 504mm RGB



Taglio Direct  
Opal 1004mm



Taglio Direct  
Opal 1004mm RGB



## Accesorios de unión Acessórios de união



Placas para instalación concatenada  
Placas para instalação concatenada

Included

Included

Included

## Accesorios de conexión Acessórios de conexão



Cable con conectores estancos macho-hembra (1m)  
Cabo com conetores estanques macho-fêmea (1 m)

-

**71-E034-00-00**

-



Cable con conectores estancos macho-hembra (5m)  
Cabo com conetores estanques macho-fêmea (5 m)

-

**71-E004-00-00**

-



Cable RGB con conectores estancos macho-hembra (1m)  
Cabo RGB com conetores estanques macho-fêmea (1 m)

**71-E071-00-00**

-

**71-E071-00-00**



Cable RGB con conectores estancos macho-hembra (5m)  
Cabo RGB com conetores estanques macho-fêmea (5 m)

**71-E005-00-00**

-

**71-E005-00-00**



Conector IP67 (1 entrada + 1 salida) Ø 5,5 - 7,5mm, 3 polos  
Conetor IP67 (1 entrada + 1 saída) Ø 5,5 - 7,5 mm, 3 polos

-

**71-E510-00-00**

-



Conector IP67 (1 entrada + 2 salidas) Ø 5,5 - 7,5mm, 3 polos  
Conetor IP67 (1 entrada + 2 saídas) Ø 5,5 - 7,5 mm, 3 polos

-

**71-E511-00-00**

-



Conector IP68 (1 entrada + 1 salida) Ø 5,5 - 11,5mm, 4 polos  
Conetor IP68 (1 entrada + 1 saída) Ø 5,5 - 11,5 mm, 4 polos

**71-E512-00-00**

**71-E512-00-00**

**71-E512-00-00**



Conector IP68 (1 entrada + 2 salidas) Ø 5,5 - 11,5mm, 3 polos  
Conetor IP68 (1 entrada + 2 saídas) Ø 5,5 - 11,5 mm, 3 polos

-

**71-E513-00-00**

-



Conector anticondensación IP68 (1 entrada + 1 salida) Ø 5,5 - 12mm, 4 polos  
Conetor anticondensação IP68 (1 entrada + 1 saída) Ø 5,5 - 12 mm, 4 polos

**71-E112-00-00**

**71-E112-00-00**

**71-E112-00-00**



Conector anticondensación IP68 (1 entrada + 3 salidas) Ø 5,5 - 12mm, 4 polos  
Conetor anticondensação IP68 (1 entrada + 3 saídas) Ø 5,5 - 12 mm, 4 polos

**71-E122-00-00**

**71-E122-00-00**

**71-E122-00-00**

Taglio Direct  
Optics 111mmTaglio Direct  
Optics 111mm RGBTaglio Direct  
Optics 504mm**Accesorios de unión**  
Acessórios de uniãoPlacas para instalación concatenada  
Placas para instalação concatenada

Included

Included

Included

**Accesorios de conexión**  
Acessórios de conexãoCable con conectores estancos macho-hembra (1m)  
Cabo com conetores estanques macho-fêmea (1 m)

71-E034-00-00

-

71-E034-00-00

Cable con conectores estancos macho-hembra (5m)  
Cabo com conetores estanques macho-fêmea (5 m)

71-E004-00-00

-

71-E004-00-00

Cable RGB con conectores estancos macho-hembra (1m)  
Cabo RGB com conetores estanques macho-fêmea (1 m)

-

71-E071-00-00

-

Cable RGB con conectores estancos macho-hembra (5m)  
Cabo RGB com conetores estanques macho-fêmea (5 m)

-

71-E005-00-00

-

Conector IP67 (1 entrada + 1 salida) Ø 5,5 - 7,5mm, 3 polos  
Conetor IP67 (1 entrada + 1 saída) Ø 5,5 - 7,5 mm, 3 polos

71-E510-00-00

-

71-E510-00-00

Conector IP67 (1 entrada + 2 salidas) Ø 5,5 - 7,5mm, 3 polos  
Conetor IP67 (1 entrada + 2 saídas) Ø 5,5 - 7,5 mm, 3 polos

71-E511-00-00

-

71-E511-00-00

Conector IP68 (1 entrada + 1 salida) Ø 5,5 - 11,5mm, 4 polos  
Conetor IP68 (1 entrada + 1 saída) Ø 5,5 - 11,5 mm, 4 polos

71-E512-00-00

71-E512-00-00

71-E512-00-00

Conector IP68 (1 entrada + 2 salidas) Ø 5,5 - 11,5mm, 3 polos  
Conetor IP68 (1 entrada + 2 saídas) Ø 5,5 - 11,5 mm, 3 polos

71-E513-00-00

-

71-E513-00-00

Conector anticondensación IP68 (1 entrada + 1 salida) Ø 5,5 - 12mm, 4 polos  
Conetor anticondensação IP68 (1 entrada + 1 saída) Ø 5,5 - 12 mm, 4 polos

71-E112-00-00

71-E112-00-00

71-E112-00-00

Conector anticondensación IP68 (1 entrada + 3 salidas) Ø 5,5 - 12mm, 4 polos  
Conetor anticondensação IP68 (1 entrada + 3 saídas) Ø 5,5 - 12 mm, 4 polos

71-E122-00-00

71-E122-00-00

71-E122-00-00

Taglio Direct  
Optics 504mm RGB

Taglio Direct  
Optics 1004mm

Taglio Direct  
Optics 1004mm RGB



### Accesorios de unión Acessórios de união



Placas para instalación concatenada  
Placas para instalação concatenada

Included

Included

Included

### Accesorios de conexión Acessórios de conexão



Cable con conectores estancos macho-hembra (1m)  
Cabo com conetores estanques macho-fêmea (1 m)

-

71-E034-00-00

-



Cable con conectores estancos macho-hembra (5m)  
Cabo com conetores estanques macho-fêmea (5 m)

-

71-E004-00-00

-



Cable RGB con conectores estancos macho-hembra (1m)  
Cabo RGB com conetores estanques macho-fêmea (1 m)

71-E071-00-00

-

71-E071-00-00



Cable RGB con conectores estancos macho-hembra (5m)  
Cabo RGB com conetores estanques macho-fêmea (5 m)

71-E005-00-00

-

71-E005-00-00



Conector IP67 (1 entrada + 1 salida) Ø 5,5 - 7,5mm, 3 polos  
Conetor IP67 (1 entrada + 1 saída) Ø 5,5 - 7,5 mm, 3 polos

-

71-E510-00-00

-



Conector IP67 (1 entrada + 2 salidas) Ø 5,5 - 7,5mm, 3 polos  
Conetor IP67 (1 entrada + 2 saídas) Ø 5,5 - 7,5 mm, 3 polos

-

71-E511-00-00

-



Conector IP68 (1 entrada + 1 salida) Ø 5,5 - 11,5mm, 4 polos  
Conetor IP68 (1 entrada + 1 saída) Ø 5,5 - 11,5 mm, 4 polos

71-E512-00-00

71-E512-00-00

71-E512-00-00



Conector IP68 (1 entrada + 2 salidas) Ø 5,5 - 11,5mm, 3 polos  
Conetor IP68 (1 entrada + 2 saídas) Ø 5,5 - 11,5 mm, 3 polos

-

71-E513-00-00

-



Conector anticondensación IP68 (1 entrada + 1 salida) Ø 5,5 - 12mm, 4 polos  
Conetor anticondensação IP68 (1 entrada + 1 saída) Ø 5,5 - 12 mm, 4 polos

71-E112-00-00

71-E112-00-00

71-E112-00-00



Conector anticondensación IP68 (1 entrada + 3 salidas) Ø 5,5 - 12mm, 4 polos  
Conetor anticondensação IP68 (1 entrada + 3 saídas) Ø 5,5 - 12 mm, 4 polos

71-E122-00-00

71-E122-00-00

71-E122-00-00

# Taglio Indirect



Iluminación indirecta en el suelo  
Iluminação indireta no chão

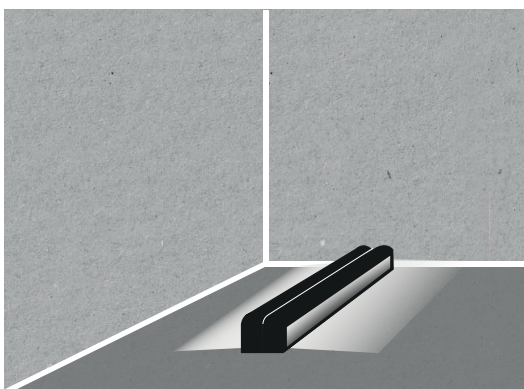
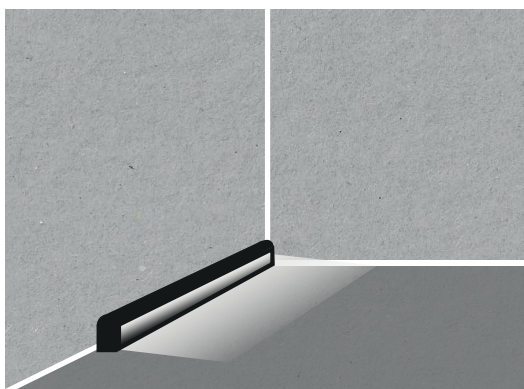

IP	IK	UGR			SEA SIDE SUITABLE		(SC)
66	10	<10	0.15 m				

Z5\* 14\* 60\* 34\* J6\* E3\* DL\* 54

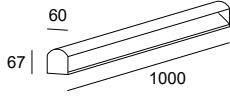

LED							24VDC
K	CRI	W	Real Lm	Optics	Code		
3000	80	9.6	184	83°	55-E034	Z5	
						J6	
						E3	
						DL	- CL
						54	
4000	80	9.6	184	83°	55-E034	Z5	
						J6	
						E3	
						DL	- CM
						54	
RGB		9.6	138	83°	55-E071	Z5	
						J6	
						E3	
						DL	- 00
						54	
						14	
						60	
						34	

Taglio Indirect Surface

Taglio Indirect Surface RGB



## Fuentes de alimentación

### Fontes de alimentação

P. 1166



ON-OFF  
IP67

**71-6341-00-00**

Min.1 - Max.9

-



DALI2  
IP67

**71-E099-00-00**

Min.1 - Max.11

-



Fuente de alimentación estanca con conectores IP67  
Fonte de alimentação estanque com conectores IP67

**71-E101-05-05**

Min.1 - Max.2

-

## Controladores

### Controladores

P. 1166



CASAMBI  
IP20

-

**71-8050-00-00**

Min.1 - Max.14



CASAMBI  
IP67

**71-A242-00-00**

Min.2 - Max.11

-



Controlador DMX  
Controlador DMX

-

**71-3493-00-00**

Min.1 - Max.14

## Accesorios de unión

### Acessórios de união



Placas para instalación concatenada  
Placas para instalação concatenada

Included

Included



### Accesorios de conexión

### Accessórios de conexão

	Cable con conectores estancos macho-hembra (1m) Cabo com conetores estanques macho-fêmea (1 m)	<b>71-E034-00-00</b>	-
	Cable con conectores estancos macho-hembra (5m) Cabo com conetores estanques macho-fêmea (5 m)	<b>71-E004-00-00</b>	-
	Cable RGB con conectores estancos macho-hembra (1m) Cabo RGB com conetores estanques macho-fêmea (1 m)	-	<b>71-E071-00-00</b>
	Cable RGB con conectores estancos macho-hembra (5m) Cabo RGB com conetores estanques macho-fêmea (5 m)	-	<b>71-E005-00-00</b>
	Conectores estancos Conetores estanques	Included	Included
	Conector IP67 (1 entrada + 1 saída) Ø 5,5 - 7,5mm, 3 polos Conetor IP67 (1 entrada + 1 saída) Ø 5,5 - 7,5 mm, 3 polos	<b>71-E510-00-00</b>	-
	Conector IP67 (1 entrada + 2 salidas) Ø 5,5 - 7,5mm, 3 polos Conetor IP67 (1 entrada + 2 saídas) Ø 5,5 - 7,5 mm, 3 polos	<b>71-E511-00-00</b>	-
	Conector IP68 (1 entrada + 1 saída) Ø 5,5 - 11,5mm, 4 polos Conetor IP68 (1 entrada + 1 saída) Ø 5,5 - 11,5 mm, 4 polos	<b>71-E512-00-00</b>	<b>71-E512-00-00</b>
	Conector IP68 (1 entrada + 2 salidas) Ø 5,5 - 11,5mm, 3 polos Conetor IP68 (1 entrada + 2 saídas) Ø 5,5 - 11,5 mm, 3 polos	<b>71-E513-00-00</b>	-
	Conector anticondensación IP68 (1 entrada + 1 saída) Ø 5,5 - 12mm, 4 polos Conetor anticondensação IP68 (1 entrada + 1 saída) Ø 5,5 - 12 mm, 4 polos	<b>71-E112-00-00</b>	<b>71-E112-00-00</b>
	Conector anticondensación IP68 (1 entrada + 3 salidas) Ø 5,5 - 12mm, 4 polos Conetor anticondensação IP68 (1 entrada + 3 saídas) Ø 5,5 - 12 mm, 4 polos	<b>71-E122-00-00</b>	<b>71-E122-00-00</b>
	Cable impermeable Cabo impermeável	Included	Included





# Vercle

Designed by Artec Studio



+ Vercle

## Iluminación minimalista para vegetación

## Iluminação minimalista para vegetação

La colección Vercle es concebida para dar el verdadero protagonismo a la vegetación y crear espacios más puros y relajados entre el paisaje y las personas. Una colección minimalista e invisible que permite iluminar el contorno de los árboles y todo tipo de elementos vegetales.

A coleção Vercle foi concebida para dar à vegetação o verdadeiro protagonista e criar espaços mais puros e relaxados entre a paisagem e as pessoas. Uma coleção minimalista e invisível que permite iluminar os contornos das árvores e todo o tipo de elementos vegetais.



### Circular

400 mm

650 mm

1200 mm



### Linear

500 mm

1970 mm



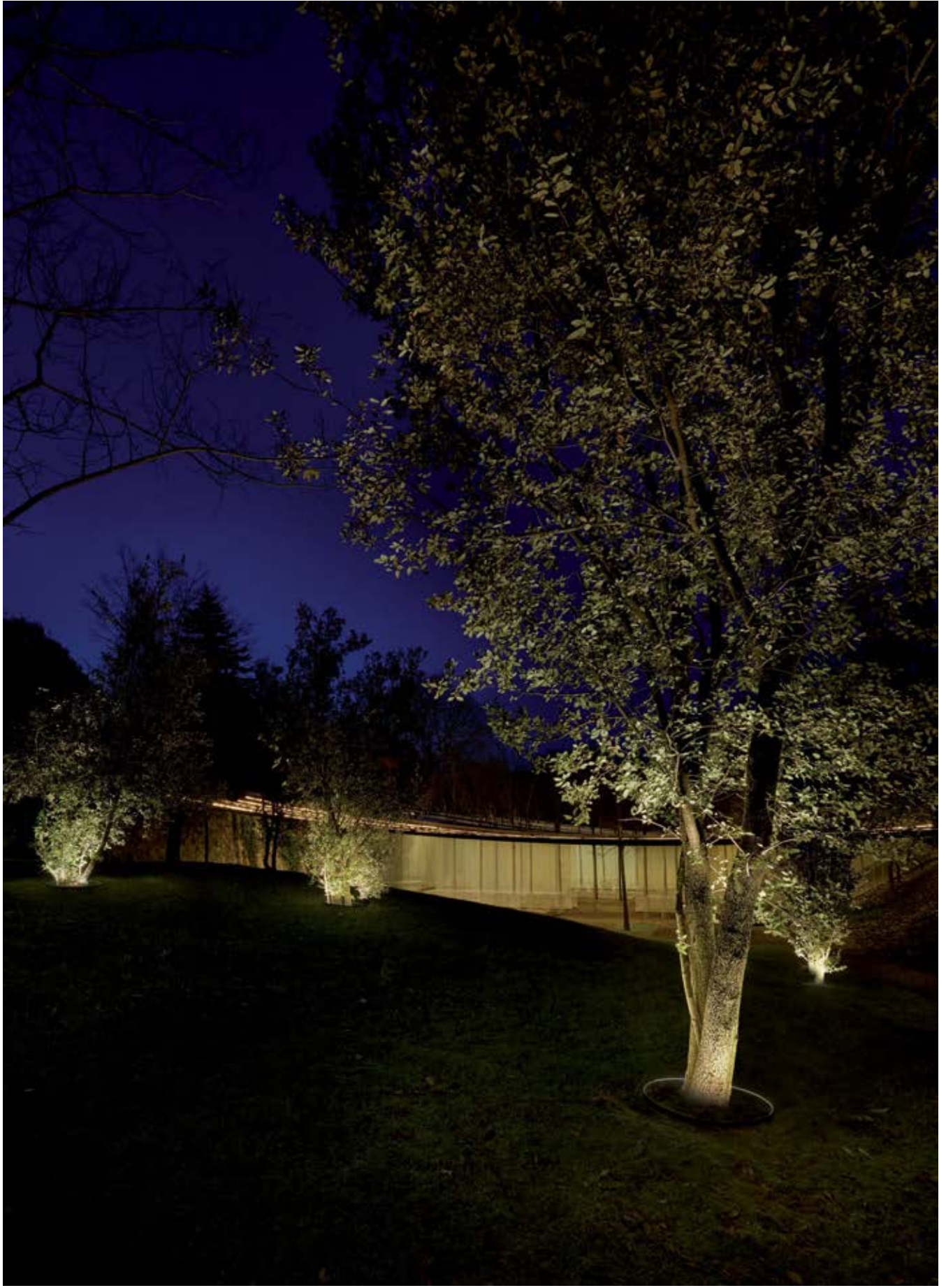









Pensada para ser invisible  
e iluminar mucho  
Pensada para ser invisível  
e iluminar muito

Parte exterior del perfil más elevada que la inferior para maximizar el confort visual.  
A parte exterior do perfil é mais elevada que a inferior para maximizar o conforto visual.



Luz adaptable  
a cada escena  
Luz adaptável  
a cada cena

El control total de la luz de Vercle permite crear distintas escenas adaptables a la arquitectura del espacio y de cada momento.  
O controlo total da luz de Vercle permite a criação de diferentes cenas adaptáveis à arquitetura do espaço e de cada momento.



## Diseño cuidado y compacto Design cuidado e compacto



Sólo 17mm de alto.  
Apenas 17mm de altura.



Sólo 10mm de ancho.  
Apenas 10mm de largura.

## Composiciones Composições

Vercle permite crear composiciones propias combinando el modelo circular y lineal.

Vercle permite criar as suas próprias composições através da combinação do modelo circular com o linear.



Composición de Vercle circular 650mm y lineal de 1970mm.  
Composição de Vercle circular de 650mm e linear de 1970mm.

## Instalaciones Instalações

Se incluyen estacas de diferentes alturas para la fijación en terrenos blandos.

Estão incluídas estacas de diferentes alturas para a fixação em terrenos macios.

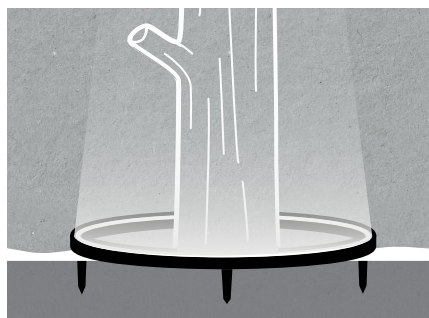

Superficie plana  
Superficie plana

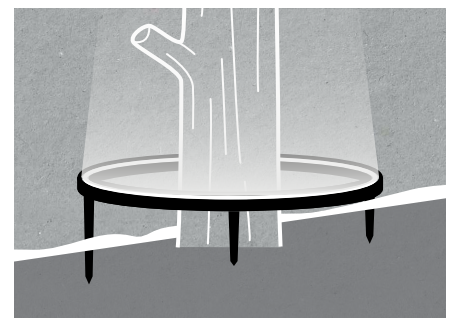

Superficie inclinada  
Superficie inclinada



BODY MAT
AL



50000h
L80 B20

3
MacAdam

## Vercle Round 400mm

IP	IK	UGR				
65	10	<16				

●  
05

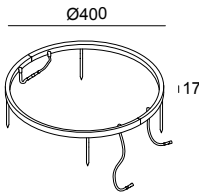

LED						24VDC
K	CRI	W	Real Lm	Code		
3000	80	26	589	<b>55-E117 - 05 - CL</b>		

## Vercle Round 650mm

IP	IK	UGR				
65	10	<10				

●  
05

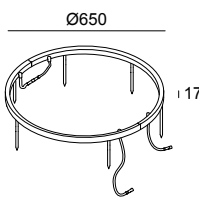

LED						24VDC
K	CRI	W	Real Lm	Code		
3000	80	43.9	1001	<b>55-E118 - 05 - CL</b>		

## Vercle Round 1200mm

	IP	IK	UGR				
	65	10	<10				

●  
05

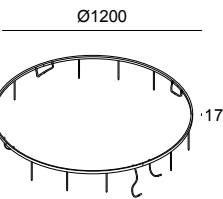
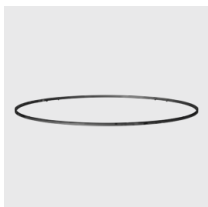



LED						24VDC
K	CRI	W	Real Lm	Code		
3000	80	64.8	1567	<b>55-E021 - 05 - CL</b>		

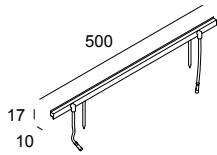

**Vercle Lineal 500mm**

IP	IK	UGR		SEA SIDE SUITABLE		(SC)
65	10	<19				



LED					 24VDC
K	CRI	W	Real Lm	Code	
3000	80	10.3	211	<b>55-E119 - 05 - CL</b>	

05

**Vercle Lineal 1970mm**

IP	IK	UGR		SEA SIDE SUITABLE		(SC)
65	10	<19				

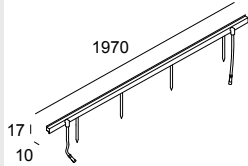
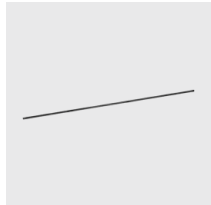

LED					 24VDC
K	CRI	W	Real Lm	Code	
3000	80	42.5	869	<b>55-E120 - 05 - CL</b>	

05

Vercle Round  
400mmVercle Round  
650mmVercle Round  
1200mm**Fuentes de alimentación**  
Fontes de alimentação

P. 1166

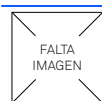
ON-OFF  
IP67**71-6345-00-00**   
Min.1 - Max.9**71-6345-00-00**   
Min.1 - Max.5**71-6345-00-00**   
Min.1 - Max.2DALI2  
IP67**71-E099-00-00**   
Min.1 - Max.4**71-E099-00-00**   
Min.1 - Max.2**71-E099-00-00**   
Min.1 - Max.1Fuente de alimentación estanca con conectores IP67  
Fonte de alimentação estanque com conectores IP67

-

-

-

**Controladores**  
Controladores

P. 1166

CASAMBI  
IP67**71-A242-00-00**   
Min.1 - Max.4**71-A242-00-00**   
Min.1 - Max.2**71-A242-00-00**   
Min.1 - Max.1**Accesorios de fijación**  
Acessórios de fixaçãoEstaca  
Estaca

Included

Included

Included

**Accesorios de conexión**  
Acessórios de conexãoCable con conectores estancos macho-hembra (5m)  
Cabo com conetores estanques macho-fêmea (5 m)**71-E118-05-05****71-E118-05-05****71-E118-05-05**Conectores estancos  
Conetores estanques

Included

Included

Included

Conector anticondensación IP68 (1 entrada + 1 salida) Ø  
5,5 - 12mm, 4 polos  
Conetor anticondensação IP68 (1 entrada + 1 saída) Ø  
5,5 - 12 mm, 4 polos**71-E112-00-00****71-E112-00-00****71-E112-00-00**Conector anticondensación IP68 (1 entrada + 3 salidas)  
Ø 5,5 - 12mm, 4 polos  
Conetor anticondensação IP68 (1 entrada + 3 saídas) Ø  
5,5 - 12 mm, 4 polos**71-E122-00-00****71-E122-00-00****71-E122-00-00**



**Fuentes de alimentación**  
Fontes de alimentação

P. 1166



ON-OFF  
IP67

**71-6341-00-00**   
Min.1 - Max.9

**71-6345-00-00**   
Min.1 - Max.5



DALI2  
IP67

**71-E099-00-00**   
Min.1 - Max.11

**71-E099-00-00**   
Min.1 - Max.2



Fuente de alimentación estanca con conectores IP67  
Fonte de alimentação estanque com conectores IP67

**71-E101-05-05**   
Min.1 - Max.1

-

**Controladores**  
Controladores

P. 1166



CASAMBI  
IP67

**71-A242-00-00**   
Min.1 - Max.11

**71-A242-00-00**   
Min.1 - Max.2

**Accesorios de fijación**  
Acessórios de fixação



Estaca  
Estaca

Included

Included

**Accesorios de conexión**  
Acessórios de conexão



Cable con conectores estancos macho-hembra (5m)  
Cabo com conetores estanques macho-fêmea (5 m)

**71-E118-05-05**

**71-E118-05-05**



Conectores estancos  
Conetores estanques

Included

Included



Conector anticondensación IP68 (1 entrada + 1 salida) Ø 5,5 - 12mm, 4 polos  
Conetor anticondensação IP68 (1 entrada + 1 saída) Ø 5,5 - 12 mm, 4 polos

**71-E112-00-00**

**71-E112-00-00**



Conector anticondensación IP68 (1 entrada + 3 salidas) Ø 5,5 - 12mm, 4 polos  
Conetor anticondensação IP68 (1 entrada + 3 saídas) Ø 5,5 - 12 mm, 4 polos

**71-E122-00-00**

**71-E122-00-00**

# Convert

Designed by LedsC4 Architectural



Iluminación uniforme, sin ningún tipo de residuo que entorpezca la homogeneidad lumínica, en fachadas de altura media.

Iluminação uniforme, sem qualquer tipo de resíduos que impeça a homogeneidade lumínica, em fachadas de altura média.



Iluminación para fachadas de altura media  
Iluminação para fachadas de altura média

## Convert Surface

# 584

356 mm



○  
54

984 mm



○  
54

12.2 - 45 W  
43° x 16°



## Convert Recessed

# 585

330 mm



○  
34

1000 mm



12.2 - 45 W  
43° x 16°



# Ópticas Óticas



Óptica elíptica 41° x 13° (05-9750-54-CL)  
Ótica elíptica 41° x 13° (05-9750-54-CL)

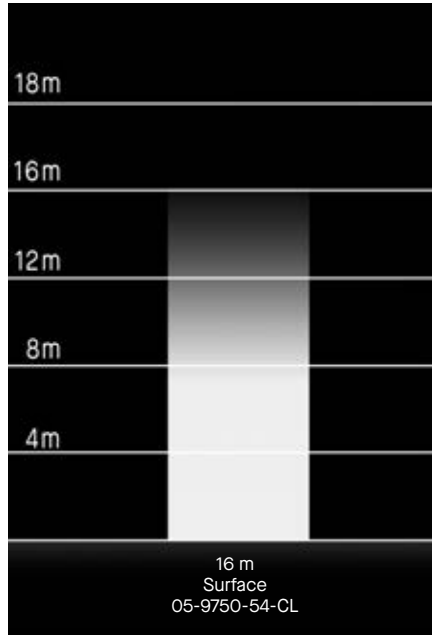

Las ópticas elípticas permiten iluminar más anchura de pared con el mínimo de piezas.

As óticas elípticas permitem a iluminação mais larga da parede com o mínimo de peças.



Módulo LED inclinado 5° en la versión de empotrar para dirigir el flujo lumínico en la pared y no generar luz residual.

Módulo LED inclinado em 5° na versão de encastrar para dirigir o fluxo lumínico na parede e não gerar luz residual.

# Convert Surface

BODY MAT	DIF MAT		50000h	3
AL	GLA		L80 B20	MacAdam

## Convert Surface 356mm

IP	IK	UGR	BREEAM		SEA SIDE SUITABLE	±90°		
66	03	<13						

54

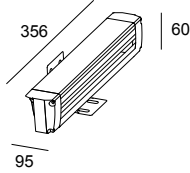

LED							
K	CRI	W Total	Real Lm	Optics	Code		
3000	80	12.9	1170	Elíptico 41° x 13°	<b>05-9749 - 54 - CL</b>	ON-OFF 100-240V	
4000	80	12.9	1228	Elíptico 41° x 13°	<b>05-9749 - 54 - CM</b>	ON-OFF 100-240V	

## Convert Surface 984mm

IP	IK	BREEAM		SEA SIDE SUITABLE	±90°		
66	03						

54

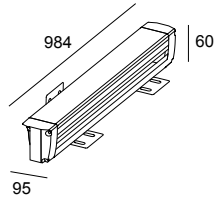

LED							
K	CRI	W Total	Real Lm	Optics	Code		
3000	80	36.5	2909	Elíptico 41° x 13°	<b>05-9750 - 54 - CL</b>	ON-OFF 100-240V	
4000	80	36.5	3055	Elíptico 41° x 13°	<b>05-9750 - 54 - CM</b>	ON-OFF 100-240V	

Convert Surface 356mm

Convert Surface 984mm



### Accesorios de fijación Acessórios de fixação



Brazos alargadores 307mm  
Braços extensores 307mm

71-E155-CA-CA

71-E155-CA-CA

## Convert Recessed 330mm

IP	IK	BREEAM			SEA SIDE SUITABLE		
65	10		250 Kg				

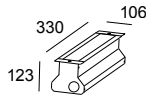

317x133

LED							
K	CRI	W Total	Real Lm	Optics	Code		
3000	80	15.6	1261	Eliptic 43° x 19°	<b>55-E074 - 34 - CL</b>	ON-OFF 100-240V	
4000	80	15.6	1261	Eliptic 43° x 19°	<b>55-E074 - 34 - CM</b>	ON-OFF 100-240V	

## Convert Recessed 1000mm

IP	IK	UGR	BREEAM			SEA SIDE SUITABLE		
65	10	<10		250 Kg				

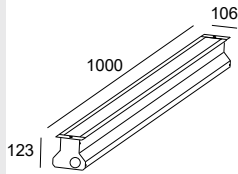

987x133

LED							
K	CRI	W Total	Real Lm	Optics	Code		
3000	80	45.7	3522	Eliptic 43° x 19°	<b>55-9958 - 34 - CL</b>	0-10V 100-240V	
4000	80	45.7	3522	Eliptic 43° x 19°	<b>55-9958 - 34 - CM</b>	0-10V 100-240V	

### Convert Recessed 330mm

### Convert Recessed 1000mm



### Accesorios de fijación Acessórios de fixação



Caja de empotrar  
Caixa de encastrar

Included

Included

### Accesorios de unión Acessórios de união



Accesorio de concatenación  
Acessório de concatenação

Included

Included



# Mex

Designed by LedsC4 Architectural



+ Mex

## Solución compacta para fachadas de poca altura Solução compacta para fachadas de pouca altura

Discreta y elegante, Mex es un bañador de pared que busca iluminar sin ser visto. La homogeneidad y el efecto de Dark Light de esta colección, consiguen que la percepción visual sobre la pared iluminada sea un regalo para los sentidos.

Discreto e elegante, Mex é um washlight de parede que visa iluminar sem ser visto. A homogeneidade e o efeito de Dark Light desta coleção fazem com que a percepção visual da parede iluminada seja um deleite para os sentidos.



### Surface

330 mm

1000 mm



### Recessed

334 mm

1004 mm





# Ópticas Óticas

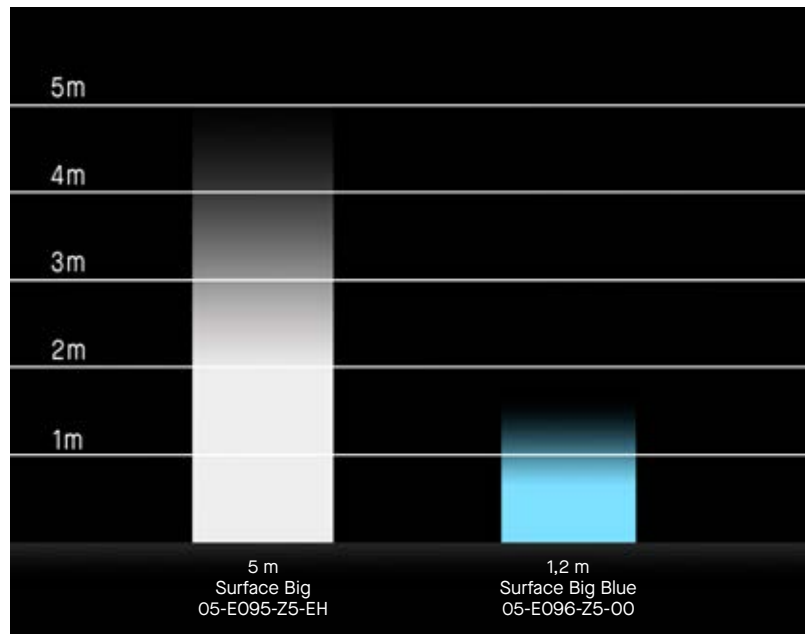

- ① Módulo LED  
Módulo LED
- ② Reflector  
Refletor
- ③ Antideslumbrante  
Antiencadeamento

Los LEDs están ocultos dentro del perfil y luz se emite por reflexión sin generar deslumbramiento.

Os LEDs estão ocultos dentro do perfil e a luz é emitida por reflexão sem gerar encadeamento.

FAMILIA/FAMÍLIA: Mex Recessed

IP	IK	UGR			SEA SIDE SUITABLE		LED	DRIVER	(SC)
65	09	<10	0.2 m			+15° -90°			

## Mex Surface 330mm

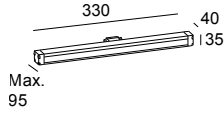

LED						24VDC
<b>K</b>	<b>CRI</b>	<b>W</b>	<b>Real Lm</b>	<b>Optics</b>	<b>Code</b>	
RGBW		9.8	151	71°	<b>05-E094 - Z5 - 00</b>	
SW 2700-3200-4000	80	9.8	314	50°	<b>05-E093 - Z5 - EH</b>	

Z5

IP	IK	UGR			SEA SIDE SUITABLE		LED	DRIVER	(SC)
65	09	<10	0.2 m			+15° -90°			

## Mex Surface 1000mm

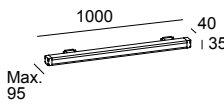

LED						24VDC
<b>K</b>	<b>CRI</b>	<b>W</b>	<b>Real Lm</b>	<b>Optics</b>	<b>Code</b>	
RGBW		24	370	71°	<b>05-E096 - Z5 - 00</b>	
SW 2700-3200-4000	80	24	769	50°	<b>05-E095 - Z5 - EH</b>	

Z5



Mex Led 330mm      Mex RGBW 330mm      Mex Led 1000mm      Mex RGBW 1000mm



## Fuentes de alimentación

### Fontes de alimentação

P. 1166

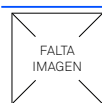

ON-OFF  
IP20

-

**71-6343-00-00**   
Min.1 - Max.15

-

**71-6343-00-00**   
Min.1 - Max.6



ON-OFF  
IP67

**71-E159-00-00**   
Min.1 - Max.6

**71-E159-00-00**   
Min.1 - Max.6

**71-6345-00-00**   
Min.1 - Max.9

**71-6345-00-00**   
Min.1 - Max.9



DALI2  
IP67

**71-E098-00-00**   
Min.1 - Max.6

-

**71-E099-00-00**   
Min.1 - Max.5

-



Fuente de alimentación estanca con  
conectores IP67  
Fonte de alimentação estanque com  
conectores IP67

**71-E101-05-05**   
Min.1 - Max.2

-

-

-

## Controladores

### Controladores

P. 1166



CASAMBI  
IP20

-

**71-8050-00-00**   
Min.1 - Max.15

-

**71-8050-00-00**   
Min.1 - Max.6



CASAMBI  
IP67

**71-A242-00-00**   
Min.3 - Max.12

-

**71-A242-00-00**   
Min.1 - Max.5

-



Controlador DMX  
Controlador DMX

-

**71-3493-00-00**   
Min.1 - Max.15

-

**71-3493-00-00**   
Min.1 - Max.6

## Accesorios de conexión

### Acessórios de conexão



Cable con conectores estancos macho-  
hembra (5m)  
Cabo com conetores estanques macho-  
fêmea (5 m)

**71-E110-00-00**

**71-E111-00-00**

**71-E110-00-00**

**71-E111-00-00**



Conectores estancos  
Conetores estanques

-

Included

-

-



Conector IP68 (1 entrada + 1 salida) Ø 6 -  
17mm, 5 polos  
Conetor IP68 (1 entrada + 1 saída) Ø 6 - 17  
mm, 5 polos

-

**71-E361-00-00**

-

**71-E361-00-00**



Conector anticondensación IP68 (1 entrada  
+ 1 salida) Ø 5,5 - 12mm, 4 polos  
Conetor anticondensação IP68 (1 entrada +  
1 saída) Ø 5,5 - 12 mm, 4 polos

**71-E112-00-00**

-

**71-E112-00-00**

-



Conector anticondensación IP68 (1 entrada  
+ 3 salidas) Ø 5,5 - 12mm, 4 polos  
Conetor anticondensação IP68 (1 entrada +  
3 saídas) Ø 5,5 - 12 mm, 4 polos

**71-E122-00-00**

-

**71-E122-00-00**

-



Caja de conexión IP68 (1 entrada + 5  
salidas) Ø 6,5 - 11mm, 6 polos  
Caixa de ligação IP68 (1 entrada + 5 saídas)  
Ø 6,5 - 11 mm, 6 polos

**71-9199-05-05**

**71-9199-05-05**

**71-9199-05-05**

**71-9199-05-05**

## Mex Recessed 334mm

IP 65	IK 09	UGR <10	250 Kg	0.2 m		SEA SIDE SUITABLE	+15° -90°	LED
----------	----------	------------	--------	-------	--	----------------------	-----------	-----

DRIVER (SC)

Z5

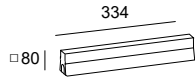
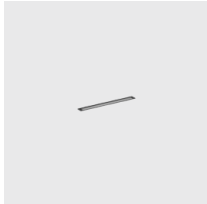

LED						24VDC
K	CRI	W	Real Lm	Optics	Code	
RGBW		9.8	151	71°	55-E094 - Z5 - 00	
SW 2700-3200-4000	80	9.8	314	50°	55-E093 - Z5 - EH	

## Mex Recessed 1004mm

IP 65	IK 09	UGR <10	250 Kg	0.2 m		SEA SIDE SUITABLE	+15° -90°	LED
----------	----------	------------	--------	-------	--	----------------------	-----------	-----

DRIVER (SC)

Z5

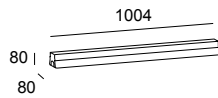

LED						24VDC
K	CRI	W	Real Lm	Optics	Code	
RGBW		24	370	71°	55-E096 - Z5 - 00	
SW 2700-3200-4000	80	24	769	50°	55-E095 - Z5 - EH	

Mex Led 330mm      Mex RGBW 330mm      Mex Led 1000mm      Mex RGBW 1000mm



## Fuentes de alimentación

### Fontes de alimentação

P. 1166

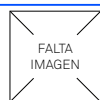

ON-OFF  
IP20

-

**71-6343-00-00**

Min.1 - Max.15

-

**71-6343-00-00**

Min.1 - Max.6



ON-OFF  
IP67

**71-E159-00-00**

Min.1 - Max.6

**71-E159-00-00**

Min.1 - Max.6

**71-6345-00-00**

Min.1 - Max.9

**71-6345-00-00**

Min.1 - Max.9



DALI2  
IP67

**71-E098-00-00**

Min.1 - Max.6

-

**71-E099-00-00**

Min.1 - Max.5

-



Fuente de alimentación estanca con  
conectores IP67  
Fonte de alimentação estanque com  
conectores IP67

**71-E101-05-05**

Min.1 - Max.2

-

-

-

## Controladores

### Controladores

P. 1166



CASAMBI  
IP20

-

**71-8050-00-00**

-

**71-8050-00-00**



CASAMBI  
IP67

**71-A242-00-00**

Min.3 - Max.12

-

**71-A242-00-00**

Min.1 - Max.5

-



Controlador DMX  
Controlador DMX

-

**71-3493-00-00**

-

**71-3493-00-00**

## Accesorios de conexión

### Acessórios de conexão



Cable con conectores estancos macho-  
hembra (5m)  
Cabo com conetores estanques macho-  
fêmea (5 m)

**71-E110-00-00**

**71-E111-00-00**

**71-E110-00-00**

**71-E111-00-00**



Conectores estancos  
Conetores estanques

-

Included

-

-



Conector IP68 (1 entrada + 1 salida) Ø 6 -  
17mm, 5 polos  
Conetor IP68 (1 entrada + 1 saída) Ø 6 - 17  
mm, 5 polos

-

**71-E361-00-00**

-

**71-E361-00-00**



Conector anticondensación IP68 (1 entrada  
+ 1 salida) Ø 5,5 - 12mm, 4 polos  
Conetor anticondensação IP68 (1 entrada +  
1 saída) Ø 5,5 - 12 mm, 4 polos

**71-E112-00-00**

-

**71-E112-00-00**

-



Conector anticondensación IP68 (1 entrada  
+ 3 salidas) Ø 5,5 - 12mm, 4 polos  
Conetor anticondensação IP68 (1 entrada +  
3 saídas) Ø 5,5 - 12 mm, 4 polos

**71-E122-00-00**

-

**71-E122-00-00**

-



Caja de conexión IP68 (1 entrada + 5  
salidas) Ø 6,5 - 11mm, 6 polos  
Caixa de ligação IP68 (1 entrada + 5 saídas)  
Ø 6,5 - 11 mm, 6 polos

**71-9199-05-05**

**71-9199-05-05**

**71-9199-05-05**

**71-9199-05-05**





# Cube Linear

Designed by LedsC4 Architectural



Precisión y control para iluminar arquitecturas exigentes

Precisão e controlo para iluminar arquiteturas exigentes

Cube Linear está concebida con la precisión de una pieza de relojería. Sus ópticas se han desarrollado para cubrir las necesidades de contornos arquitectónicos específicos, con la máxima calidad y confort. La colección cuenta con funciones mecanizadas específicas desarrolladas para facilitar su rápida instalación y conservación.

Cube Linear foi concebida com a precisão de uma peça de relojoaria. A sua ótica foi desenvolvida para satisfazer as necessidades dos contornos arquitetónicos específicos com a máxima qualidade e conforto. A coleção possui funções mecanizadas específicas desenvolvidas para facilitar a sua rápida instalação e conservação.





# Ópticas Óticas



Cube Linear Efficiency  
(12°x36°/18°x58°)  
Ópticas elípticas.  
Óticas elípticas.



Cube Linear Efficiency (6°)  
Ópticas simétricas.  
Óticas simétricas.



Cube Linear Comfort (6°)  
Ópticas simétricas con  
Honeycomb.  
Óticas simétricas con  
Honeycomb.

## Cube Linear Efficiency

Máxima  
eficiencia  
Máxima  
eficiência

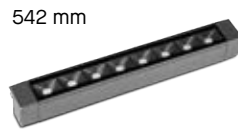

## Cube Linear Comfort

Excelente  
confort visual  
Excelente  
conforto visual

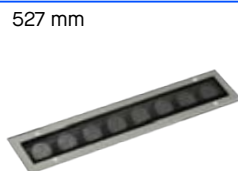
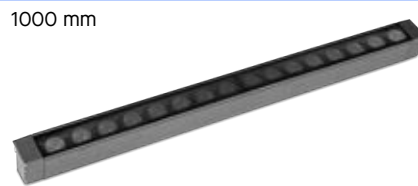



## Smart

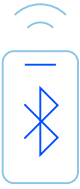

Incorporamos la tecnología Smart que añade dinamismo cromático a los espacios iluminados con los sistemas RGBW DMX RDM y DALI2.

Incorporámos a tecnologia Smart que acrescenta dinamismo cromático aos espaços iluminados com os sistemas RGBW DMX RDM e DALI2.



Una luz para cada momento adaptable a las geometrías y espacios modulares que ofrece la arquitectura.

Uma luz para cada momento, adaptável às geometrias e espaços modulares que a arquitetura oferece.

# Ópticas Ópticas

Luz para fachadas de hasta  
40 metros de altura  
Luz para fachadas de até  
40 metros de altura

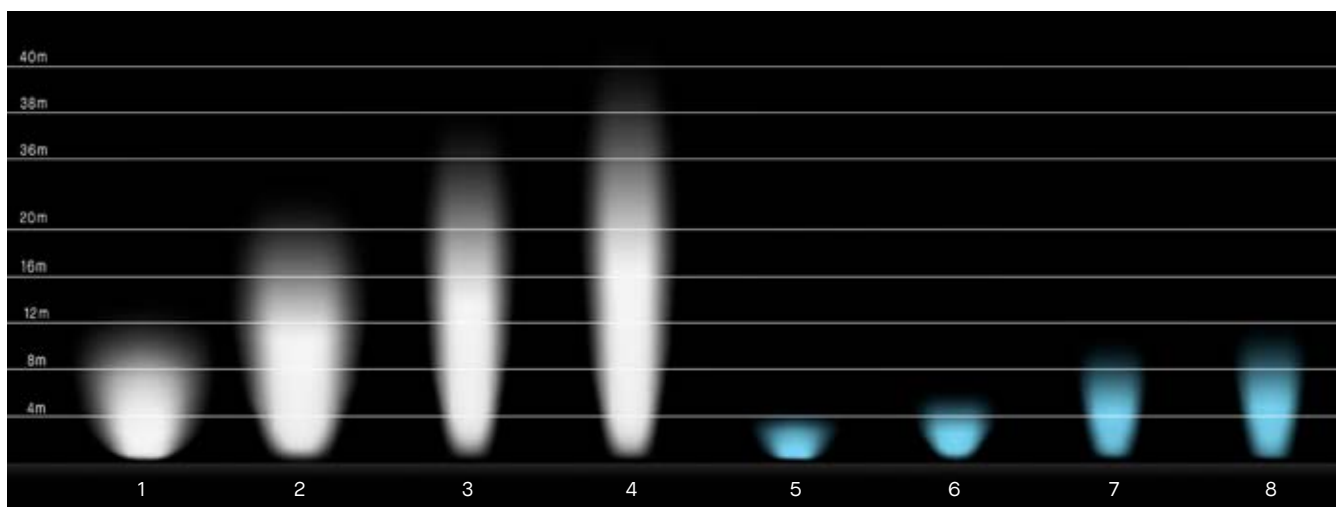

**1**  
Cube Linear Efficiency  
14 m  
BD13-88W8E6DSZ5  
18 × 58°

**2**  
Cube Linear Efficiency  
21 m  
BD13-88W8E5DSZ5  
12 × 36°

**3**  
Cube Linear Comfort  
36,5 m  
BD14-88W8S1DSZ5  
6°

**4**  
Cube Linear Efficiency  
39,5 m  
BD13-88W8S1DSZ5  
6°

**5**  
Cube Linear Efficiency RGBW  
3,9 m  
BD13-58NNE6DNZ5  
18 × 58°

**6**  
Cube Linear Efficiency RGBW  
5,5 m  
BD13-58NNE5DNZ5  
12 × 36°

**7**  
Cube Linear Comfort RGBW  
9,2 m  
BD14-58NNS1DNZ5  
6°

**8**  
Cube Linear Efficiency RGBW  
10,5 m  
BD13-58NNS1DNZ5  
6°



1



2



3

## Instalaciones Instalações



Visera basculante opcional en las versiones de superficie  
Viseira basculante opcional nas versões de superfície



Goniómetro integrado en los modelos de empotrar  
Goniómetro integrado nos modelos de encastrar

El goniómetro integrado permite bascular comodamente el módulo LED hasta  $10^\circ$  desde del exterior de la luminaria y alinear los grados de inclinación de la luz entre las luminarias.

O goniómetro integrado permite bascular comodamente o módulo LED até  $10^\circ$  desde o exterior da luminária e alinhar os graus de inclinação da luz entre as luminárias.

1



2



3





# Cube

## Linear Efficiency



BODY MAT	DIF MAT	50000h
AL	GL TMP	L80 B20

# Cube

## Cube Linear Efficiency 1000mm

	IP 65	IK 10	UGR <10			SEA SIDE SUITABLE		
--	----------	----------	------------	--	--	----------------------	--	--

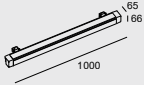
Ejemplo de código / Exemplo de código: **BD13-67V8S1BBZ5**





Model		W	K / Cri / Real lm	Optics	Source	Finishes	
 	<b>BD13 -</b> Superficie IP65	● Z5	<b>67</b> 67.6W	<b>V8</b> 2700K / CRI 80 / 6320 lm <b>W8</b> 3000K / CRI 80 / 6136 lm <b>X8</b> 4000K / CRI 80 / 4300 lm	<b>S1</b> 6° <b>E5</b> 36° <b>E6</b> 58°	<b>BB</b> 24-48 VDC	<b>Z5</b> ● <b>34</b> ○
			<b>88</b> 95W	<b>V8</b> 2700K / CRI 80 / 8888 lm <b>W8</b> 3000K / CRI 80 / 8628 lm <b>X8</b> 4000K / CRI 80 / 6040 lm	<b>S1</b> 6° <b>E5</b> 36° <b>E6</b> 58°	<b>DS</b> DALI/PUSH 220-240V	
			<b>58</b> 64W	<b>NN</b> RGBW / 3808 lm	<b>S1</b> 6° <b>E5</b> 36° <b>E6</b> 58°	<b>DN</b> DMX RDM 220-240V	
 	<b>BD17 -</b> Empotrada Encastrada IP65	○ 34					

# Cube

## Cube Linear Efficiency 500mm

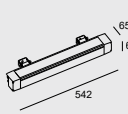

Ejemplo de código / Exemplo de código: **BD11-34V8S1BBZ5**

Model		W	K / Cri / Real lm	Optics	Source	Finishes
 <b>BD11 - Superficie IP65</b> 	● Z5	<b>34</b> 33.8W	<b>V8</b> 2700K / CRI 80 / 3160 lm	<b>S1</b> 6°	<b>BB</b>  24-48 VDC	● <b>Z5</b> ● <b>34</b>
			<b>W8</b> 3000K / CRI 80 / 3068 lm	<b>E5</b> 36°		
			<b>X8</b> 4000K / CRI 80 / 2150 lm	<b>E6</b> 58°		
 <b>BD15 - Empotrada Encastrada IP65</b> 	○ 34	<b>44</b> 47.8W	<b>V8</b> 2700K / CRI 80 / 4444 lm	<b>S1</b> 6°	<b>DS</b>  DALI/PUSH 220-240V	
			<b>W8</b> 3000K / CRI 80 / 4114 lm	<b>E5</b> 36°		
			<b>X8</b> 4000K / CRI 80 / 3020 lm	<b>E6</b> 58°		
		<b>29</b> 33W	<b>NN</b> RGBW / 1971 lm	<b>S1</b> 6°	<b>DN</b>  DMX RDM 220-240V	
				<b>E5</b> 36°		
				<b>E6</b> 58°		

Cube Linear  
Efficiency 500mm  
Surface



Cube Linear  
Efficiency 500mm  
Recessed



Cube Linear  
Efficiency  
1000mm Surface



Cube Linear  
Efficiency  
1000mm Recessed



## Fuentes de alimentación Fontes de alimentação

P. 1166



ON-OFF  
IP67

**71-7646-00-00**   
Min.1 - Max.4

**71-7646-00-00**   
Min.1 - Max.4

**71-B077-00-00**   
Min.1 - Max.4

**71-B077-00-00**   
Min.1 - Max.4

## Controladores Controladores

P. 1166



DALI  
IP67

**71-A237-00-00**

**71-A237-00-00**

**71-A237-00-00**

**71-A237-00-00**

## Accesorios de fijación Acessórios de fixação



Caja de empotrar  
Caixa de encastrar

-

Included

-

Included



Base para fijar al suelo  
Base para fixação no solo

Included

-

Included

-

## Accesorios de unión Acessórios de união



Placas para instalación concatenada  
Placas para instalação concatenada

-

Included

-

Included

## Accesorios de conexión Acessórios de conexão



Conectores estancos  
Conectores estanques

Included

Included

Included

Included



Conector IP68 (1 entrada + 1 salida) Ø 6 -  
17mm, 5 polos  
Conetor IP68 (1 entrada + 1 saída) Ø 6 - 17  
mm, 5 polos

-

**71-E361-00-00**

-

**71-E361-00-00**



Conector anticondensación IP68 (1 entrada  
+ 1 salida) Ø 5,5 - 12mm, 4 polos  
Conetor anticondensação IP68 (1 entrada +  
1 saída) Ø 5,5 - 12 mm, 4 polos

**71-E112-00-00**

**71-E112-00-00**

**71-E112-00-00**

**71-E112-00-00**



Conector anticondensación IP68 (1 entrada  
+ 3 salidas) Ø 5,5 - 12mm, 4 polos  
Conetor anticondensação IP68 (1 entrada +  
3 saídas) Ø 5,5 - 12 mm, 4 polos

**71-E122-00-00**

**71-E122-00-00**

**71-E122-00-00**

**71-E122-00-00**



Caja de conexión IP68 (1 entrada + 5  
salidas) Ø 6,5 - 11mm, 6 polos  
Caixa de ligação IP68 (1 entrada + 5 saídas)  
Ø 6,5 - 11 mm, 6 polos

**71-9199-05-05**

**71-9199-05-05**

**71-9199-05-05**

**71-9199-05-05**









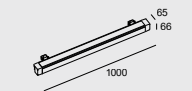

BODY MAT	DIF MAT	50000h
AL	GL TMP	L80 B20

# Cube

## Cube Linear Comfort 1000mm

NEW	IP 65	IK 10	UGR <10	0.25 m		SEA SIDE SUITABLE	LED	DRIVER
-----	----------	----------	------------	--------	--	----------------------	-----	--------

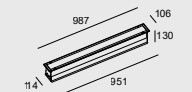
Ejemplo de código / Exemplo de código: **BD14-67V8S1BBZ5**

Model		W	K / Cri / Real lm	Optics	Source	Finishes	
 	<b>BD14 -</b> Superficie IP65	 Z5	<b>67</b> 67.6W	<b>V8</b> 2700K / CRI 80 / 5056 lm <b>W8</b> 3000K / CRI 80 / 5056 lm <b>X8</b> 4000K / CRI 80 / 5056 lm	<b>S1</b> 6°	<b>BB</b>  24-48 VDC	<b>Z5</b>  <b>34</b> 
			<b>88</b> 95W	<b>V8</b> 2700K / CRI 80 / 7110 lm <b>W8</b> 3000K / CRI 80 / 7110 lm <b>X8</b> 4000K / CRI 80 / 7110 lm	<b>S1</b> 6°	<b>DS</b>   DALI/PUSH 220-240V	
			<b>58</b> 64W	<b>NN</b> RGBW / 3136 lm	<b>S1</b> 6°	<b>DN</b>  DMX RDM 220-240V	
 	<b>BD18 -</b> Empotrada Encastrada IP65	 34					

# Cube

## Cube Linear Comfort 500mm

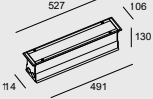

Ejemplo de código / Exemplo de código: **BD12-34V8S1BBZ5**

Model		W	K / Cri / Real lm	Optics	Source	Finishes	
 	<b>BD12 -</b> Superficie IP65	● Z5	<b>34</b> 33.8W	<b>V8</b> 2700K / CRI 80 / 2528 lm <b>W8</b> 3000K / CRI 80 / 2528 lm <b>X8</b> 4000K / CRI 80 / 2528 lm	<b>S1</b> 6°	<b>BB</b> 24-48 VDC	<b>Z5</b> ● <b>34</b> ○
			<b>44</b> 47.8W	<b>V8</b> 2700K / CRI 80 / 3555 lm <b>W8</b> 3000K / CRI 80 / 3555 lm <b>X8</b> 4000K / CRI 80 / 3555 lm	<b>S1</b> 6°	<b>DS</b> DALI/PUSH 220-240V	
			<b>29</b> 33W	<b>NN</b> RGBW / 1568 lm	<b>S1</b> 6°	<b>DN</b> DMX RDM 220-240V	
 	<b>BD16 -</b> Empotrada Encastrada IP65	○ 34					

Cube Linear  
Comfort 500mm  
Surface



Cube Linear  
Comfort 500mm  
Recessed



Cube Linear  
Comfort 1000mm  
Surface



Cube Linear  
Comfort 1000mm  
Recessed



## Fuentes de alimentación Fontes de alimentação

P. 1166



ON-OFF  
IP67

**71-7647-00-00**   
Min.1 - Max.7

**71-7647-00-00**   
Min.1 - Max.7

**71-B077-00-00**   
Min.1 - Max.4

**71-B077-00-00**   
Min.1 - Max.4

## Controladores Controladores

P. 1166



DALI  
IP67

**71-A237-00-00**

**71-A237-00-00**

**71-A237-00-00**

**71-A237-00-00**

## Accesorios ópticos Acessórios óticos



Panel de abeja  
Favo de abelha

Included

Included

Included

Included

## Accesorios de fijación Acessórios de fixação



Caja de empotrar  
Caixa de encastrar

-

Included

-

Included



Base para fijar al suelo  
Base para fixação no solo

Included

-

Included

-

## Accesorios de unión Acessórios de união



Placas para instalación concatenada  
Placas para instalação concatenada

-

Included

-

Included

## Accesorios de conexión Acessórios de conexão



Conectores estancos  
Conetores estanques

Included

Included

Included

Included



Conector IP68 (1 entrada + 1 salida) Ø 6 -  
17mm, 5 polos  
Conetor IP68 (1 entrada + 1 saída) Ø 6 - 17  
mm, 5 polos

-

**71-E361-00-00**

**71-E361-00-00**

**71-E361-00-00**



Conector anticondensación IP68 (1 entrada  
+ 1 salida) Ø 5,5 - 12mm, 4 polos  
Conetor anticondensação IP68 (1 entrada +  
1 saída) Ø 5,5 - 12 mm, 4 polos

**71-E112-00-00**

**71-E112-00-00**

**71-E112-00-00**

**71-E112-00-00**



Conector anticondensación IP68 (1 entrada  
+ 3 salidas) Ø 5,5 - 12mm, 4 polos  
Conetor anticondensação IP68 (1 entrada +  
3 saídas) Ø 5,5 - 12 mm, 4 polos

**71-E122-00-00**

**71-E122-00-00**

**71-E122-00-00**

**71-E122-00-00**



Caja de conexión IP68 (1 entrada + 5  
salidas) Ø 6,5 - 11mm, 6 polos  
Caixa de ligação IP68 (1 entrada + 5 saídas)  
Ø 6,5 - 11 mm, 6 polos

**71-9199-05-05**

**71-9199-05-05**

**71-9199-05-05**

**71-9199-05-05**

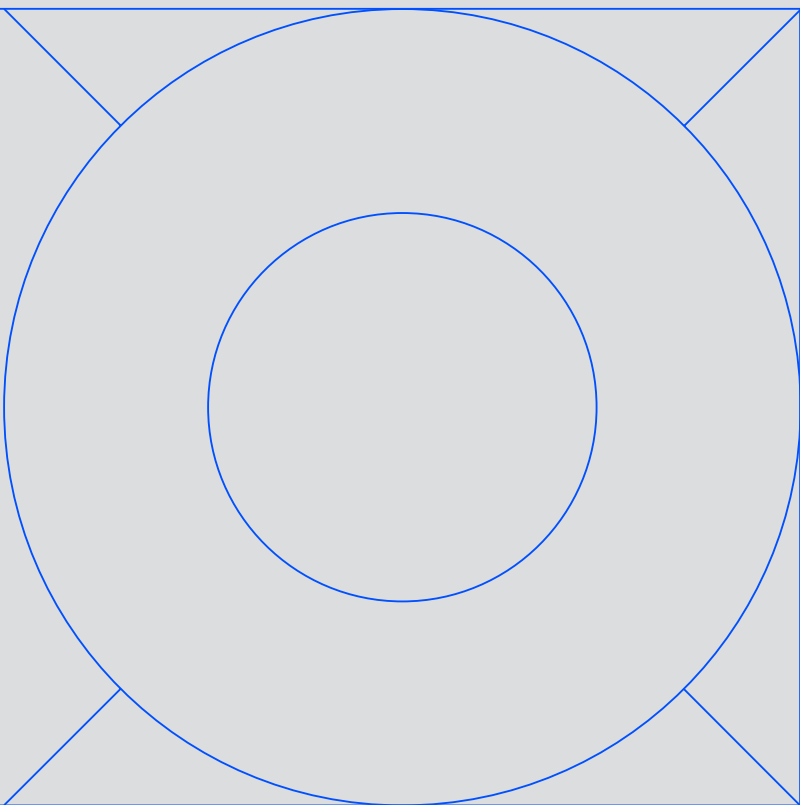

# Proyectores

# Projectores



Cube

616

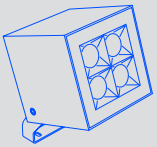

Max

626

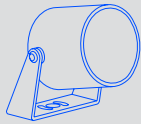

Modis

634

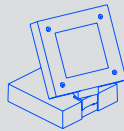

Hubble

640



Thor

660



Micro

654

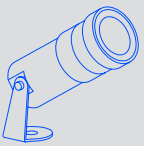

Zoom

658

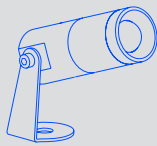

Suv

664

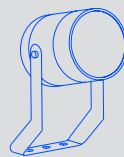

Helio

666



# Cube

Designed by LedsC4 Architectural



+ Cube

## Precisión y control Precisão e controlo

La colección Cube ha sido concebida para iluminar la arquitectura de una forma equilibrada, sin luz residual y moldeándola.

A coleção Cube foi concebida para iluminar a arquitetura de uma forma equilibrada, sem luz residual dando-lhe forma.





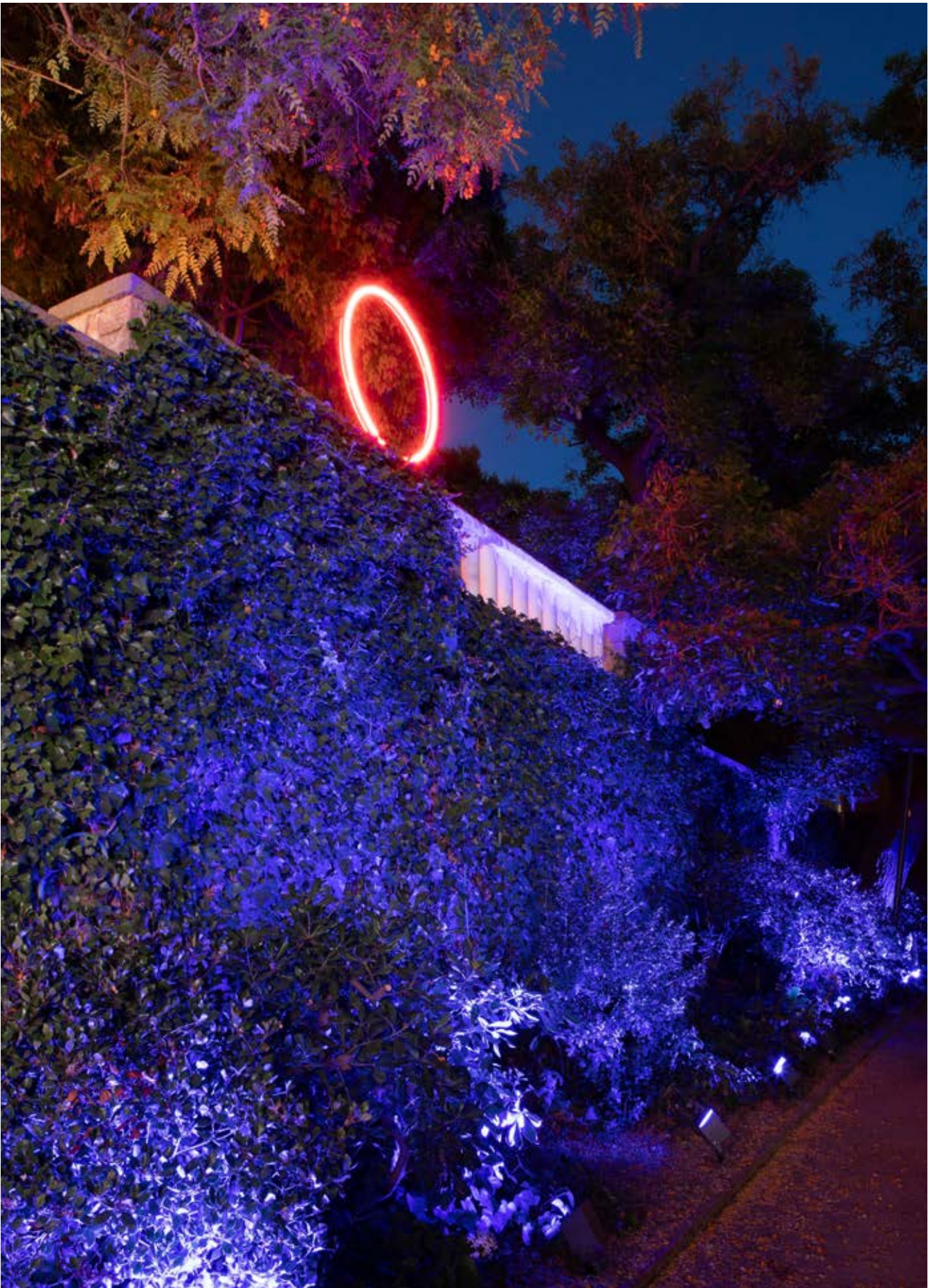

Barcelona Grec Festival 2021. Cube 4 LED.



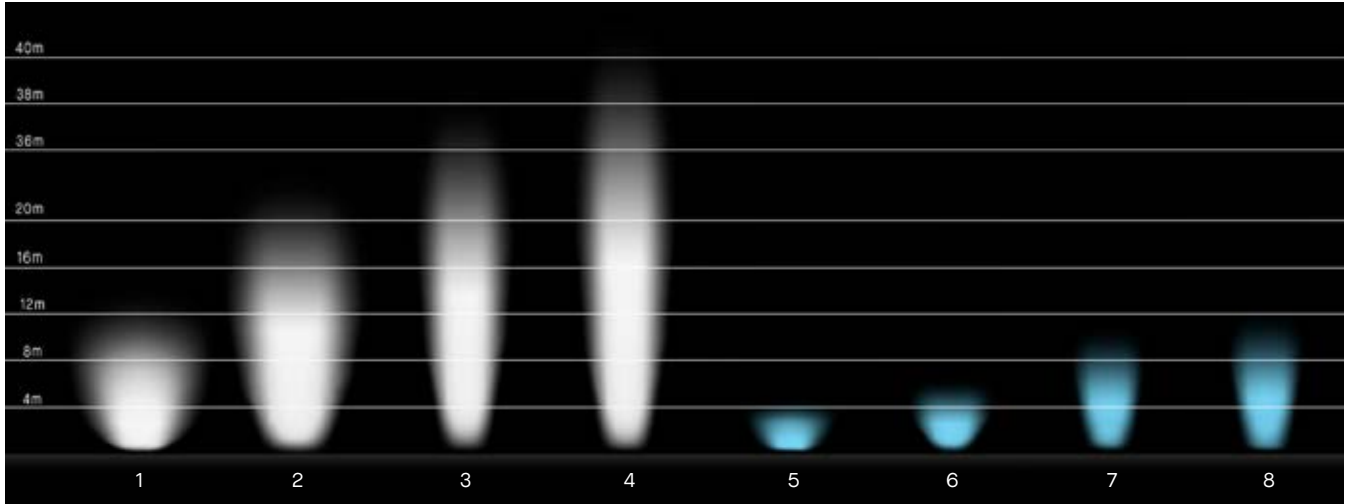

**Cube 16 LED 53W**

**1**  
14,8 m  
AN14-53W8F10UZ5  
50°

**2**  
18,4 m  
AN14-53W8M30UZ5  
35°

**3**  
21,5 m  
AN14-53W8S20UZ5  
16°

**4**  
35 m  
AN14-53W8S10UZ5  
6°

**Cube 16 LED 53W RGBW**

**5**  
4 m  
AN14-34NNF1DMZ5  
50° Blue

**6**  
4,7 m  
AN14-34NNM3DMZ5  
35° Blue

**7**  
4 m  
AN14-34NNS2DMZ5  
16° Blue

**8**  
9,5 m  
AN14-34NNS1DMZ5  
6° Blue

Instalaciones  
Instalações

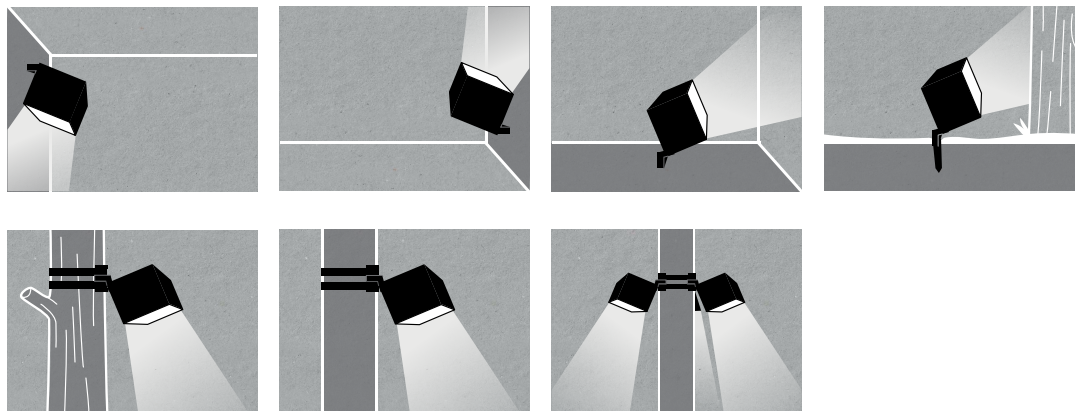



# Cube

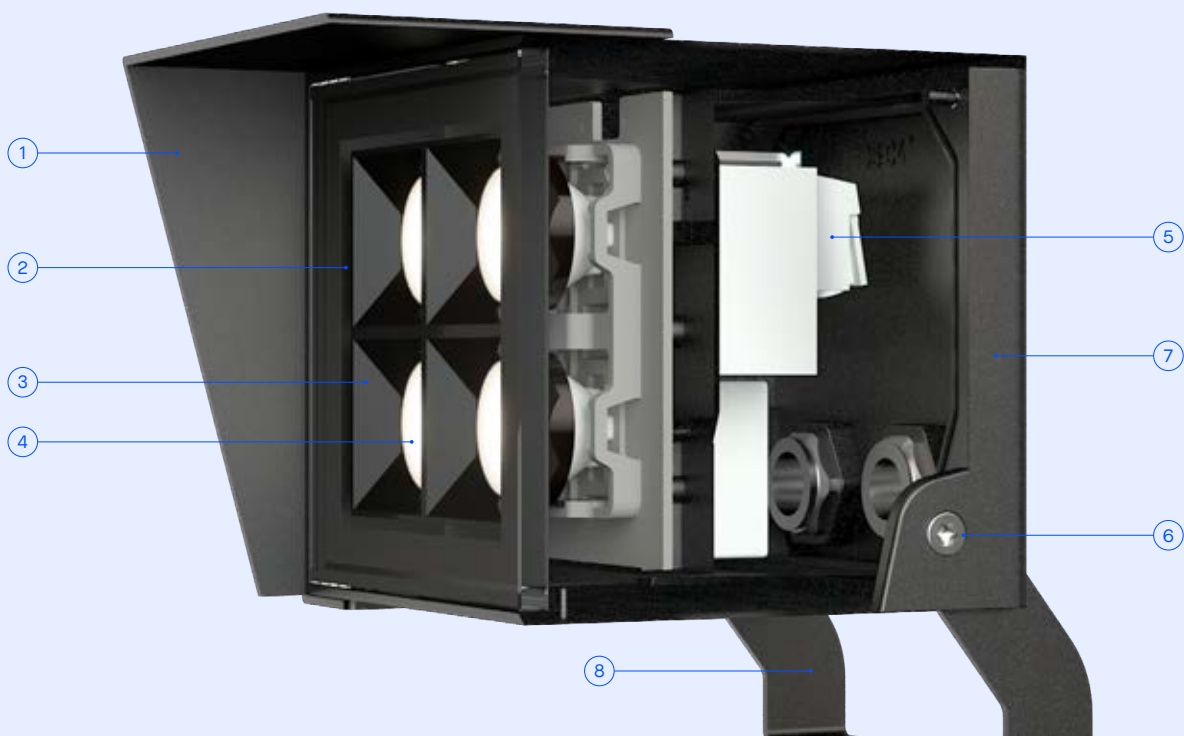

① Visera antideslumbrante  
Viseira antiencadeamento

② Difusor de cristal de 6 mm  
Difusor de vidro de 6 mm

③ Embellecedores para maximizar el confort Visual  
Embelezadores para maximizar o conforto visual

④ Ópticas desde Super Spot a Flood  
Óticas desde Super Spot a Flood

⑤ Regleta de conexión fácil sin herramientas  
Conexão sem ferramentas

⑥ Tornillería de acero inoxidable AISI316  
Parafusos de aço inoxidável AISI316

⑦ Cuerpo de aluminio inyectado con protección especial contra el óxido  
Corpo de aluminio injetado com proteção especial contra a ferrugem

⑧ Brazo basculante 90°  
Braço basculante 90°



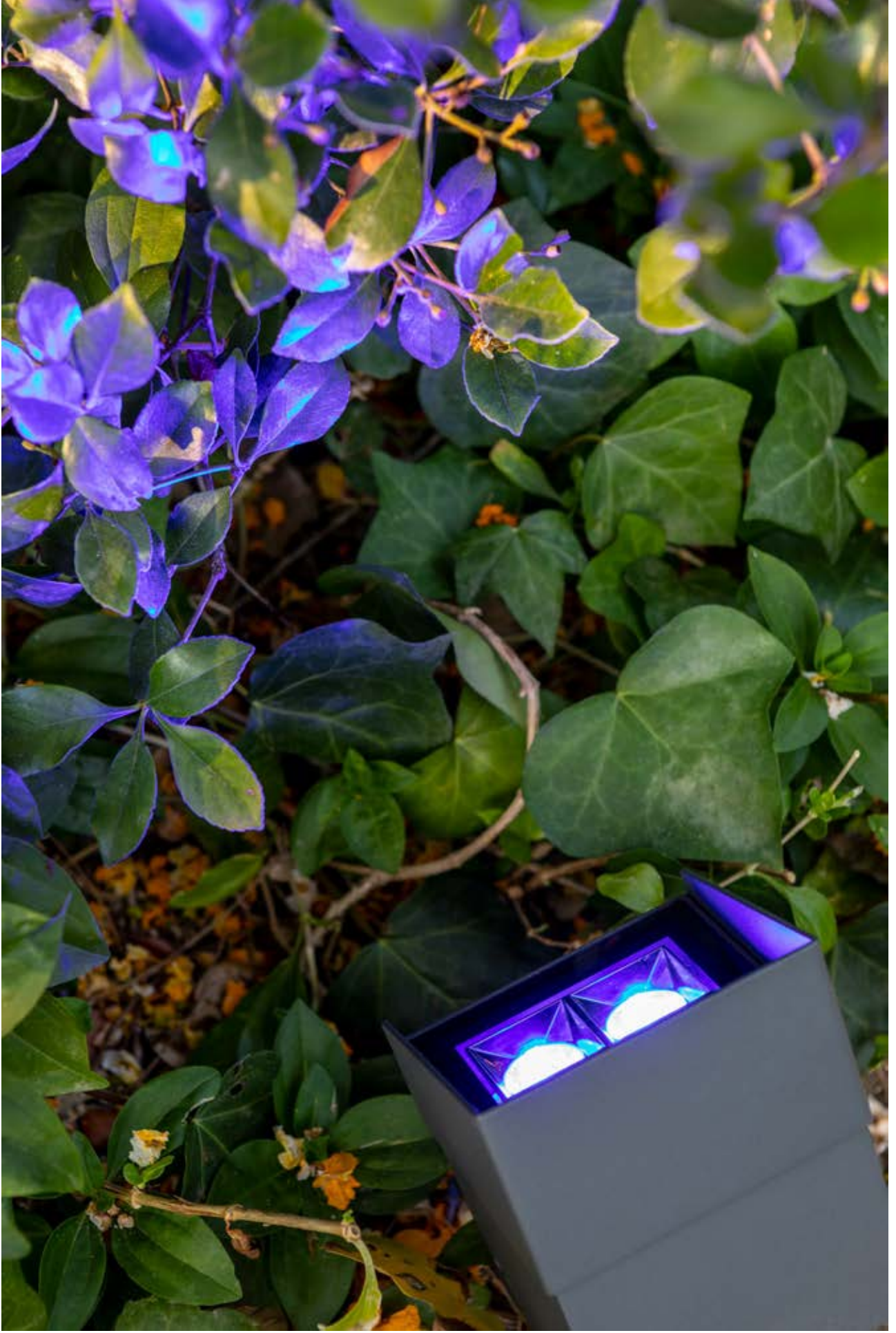



# Cube Spot

BODY MAT	DIF MAT	50000h
AL	GLA	L80 B20

FAMILIA/FAMÍLIA: Cube Linear P.XXX

## Cube Spot 1 LED

IP 66	IK 03		BREEAM	3 MacAdam		1 m		SEA SIDE SUITABLE		90°		
----------	----------	--	--------	--------------	--	-----	--	----------------------	--	-----	--	--



Ejemplo de código / Exemplo de código: AN11-P5V8S1BBZ5

Model	W	K / Cri / Real lm	Optics	Source	Finishes
<b>AN11 -</b>   	<b>P5</b> 4.5W	<b>V8</b> 2700K / CRI 80 / 387 lm	<b>S1</b> 7°	<b>BB</b> 3V/max.1500mA	<b>Z5</b>
		<b>W8</b> 3000K / CRI 80 / 399 lm			
		<b>X8</b> 4000K / CRI 80 / 411 lm			
	<b>P5</b> 5W	<b>V8</b> 2700K / CRI 80 / 426 lm	<b>S2</b> 16°	<b>BB</b> 24V/max.200mA	
		<b>W8</b> 3000K / CRI 80 / 494 lm	<b>M3</b> 37°		
		<b>X8</b> 4000K / CRI 80 / 487 lm	<b>F1</b> 54°		

## Cube Spot 4 LEDS

IP 66	IK 07		BREEAM		0 m		SEA SIDE SUITABLE		90°		
----------	----------	--	--------	--	-----	--	----------------------	--	-----	--	--







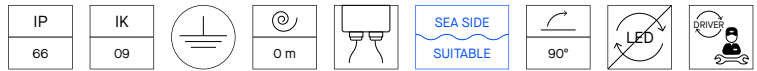

Ejemplo de código / Exemplo de código: AN12-P6V8S1DUZ5

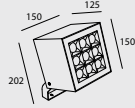
Model	W	K / Cri / Real lm	Optics	Source	Finishes	
<b>AN12 -</b>   	<b>P6</b> 7.3W	<b>V8</b> 2700K / CRI 80 / 647 lm	<b>S1</b> 7°	<b>DU</b> DALI-2 100-240V	<b>Z5</b>	
		<b>W8</b> 3000K / CRI 80 / 667 lm				
		<b>X8</b> 4000K / CRI 80 / 687 lm				
	<b>12</b> 13.7W	<b>V8</b> 2700K / CRI 80 / 1158 lm	<b>S1</b> 7°	<b>OU</b> ON-OFF 100-240V		
		<b>W8</b> 3000K / CRI 80 / 1194 lm				
		<b>X8</b> 4000K / CRI 80 / 1230 lm				
	<b>12</b> 13.2W	<b>V8</b> 2700K / CRI 80 / 1405 lm	<b>S2</b> 16°	<b>DU</b> DALI-2 100-240V		
		<b>W8</b> 3000K / CRI 80 / 1699 lm	<b>M3</b> 35°			<b>OU</b> ON-OFF 100-240V
		<b>X8</b> 4000K / CRI 80 / 1643 lm	<b>F1</b> 51°			
	<b>16</b> 16W	<b>NN</b> RGBW / CRI 80 / 908 lm	<b>S1</b> 7°	<b>BB</b> 24VDC		
			<b>S2</b> 16°			
			<b>M3</b> 35°			
<b>F1</b> 51°						

# Cube Spot 9 LEDS







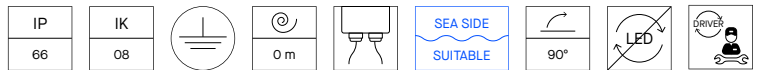

Ejemplo de código / Exemplo de código: **AN13-24V8S2DUZ5**

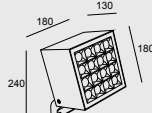
Model	W	K / Cri / Real lm	Optics	Source	Finishes	
<b>AN13 -</b>  	<b>24</b> 27W	<b>V8</b> 2700K / CRI 80 / 1939 lm	<b>S2</b> 16°	<b>DU</b>   DALI-2 120-277V	<b>Z5</b> 	
		<b>W8</b> 3000K / CRI 80 / 2345 lm	<b>M3</b> 32°			
		<b>X8</b> 4000K / CRI 80 / 2255 lm	<b>F1</b> 43°			
	<b>27</b> 30W	<b>V8</b> 2700K / CRI 80 / 2577 lm	<b>S1</b> 6°	<b>DU</b>   DALI-2 120-277V		
		<b>W8</b> 3000K / CRI 80 / 2656 lm				
		<b>X8</b> 4000K / CRI 80 / 2736 lm				
	<b>3P</b> 33W	<b>V8</b> 2700K / CRI 80 / 3268 lm	<b>S1</b> 6°	<b>OU</b>  ON-OFF 100-240V		
		<b>W8</b> 3000K / CRI 80 / 2535 lm				<b>S2</b> 16°
		<b>X8</b> 4000K / CRI 80 / 3063 lm				<b>M3</b> 32° <b>F1</b> 43°
	<b>25</b> 30W	<b>NN</b> RGBW / CRI 80 / 1690 lm	<b>S1</b> 6°	<b>DM</b>   DMX 100-277V		
						<b>S2</b> 16°
						<b>M3</b> 32°
<b>F1</b> 43°						

# Cube Spot 16 LEDS



Model	W	K / Cri / Real lm	Optics	Source	Finishes	
<b>AN14 -</b>  	<b>5P</b> 54W	<b>V8</b> 2700K / CRI 80 / 4969 lm	<b>S1</b> 7°	<b>DU</b>   DALI 220-240V	<b>Z5</b> 	
		<b>W8</b> 3000K / CRI 80 / 4847 lm	<b>S2</b> 16°			
		<b>X8</b> 4000K / CRI 80 / 5541 lm	<b>M3</b> 34° <b>F1</b> 50°			
	<b>53</b> 57W	<b>V8</b> 2700K / CRI 80 / 4820 lm	<b>S1</b> 7°	<b>OU</b>  ON-OFF 100-240V		
		<b>W8</b> 3000K / CRI 80 / 4847 lm				<b>S2</b> 16°
		<b>X8</b> 4000K / CRI 80 / 5707 lm				<b>M3</b> 34° <b>F1</b> 50°
	<b>34</b> 37W	<b>NN</b> RGBW / CRI 80 / 2147 lm	<b>S1</b> 6°	<b>DM</b>   DMX 100-277V		
						<b>S2</b> 16°
						<b>M3</b> 32°
						<b>F1</b> 43°

	Cube Spotlight 1 LED S2	Cube Spotlight 1 LED	Cube Spotlight 4 LEDS	Cube Spotlight 4 LEDS RGBW
				





## Drivers Driver

P. 1166

	ON-OFF IP20	<b>71-E217-00-00</b>  Min.1 - Max.3	<b>71-E217-00-00</b>  Min.1 - Max.3	-	-
	1-10V DALI2 IP68	<b>71-E216-00-00</b>  Min.1 - Max.15	<b>71-E216-00-00</b>  Min.1 - Max.15	-	-
	1-10V DALI2 PUSH IP20	<b>71-E221-00-00</b>  Min.1 - Max.13	<b>71-E221-00-00</b>  Min.1 - Max.13	-	-
	DALI IP20	-	<b>71-E219-00-00</b>  Min.1 - Max.2	-	-





## Fuentes de alimentación Fontes de alimentação

P. 1166

	ON-OFF IP67	-	-	-	<b>71-6341-00-00</b>  Min.1 - Max.6
	Fuente de alimentación estanca con conectores IP67 Fonte de alimentação estanque com conectores IP67	-	-	-	<b>71-E101-05-05</b>  Min.1 - Max.1

## Controladores Controladores



P. 1166





	Falta info driver	-	-	-	<b>71-A238-00-00</b>
	DALI IP67	<b>71-A237-00-00</b>  Min.BROADCAST - Max.BROADCAST	<b>71-A237-00-00</b>  Min.BROADCAST - Max.BROADCAST	<b>71-A237-00-00</b>	-

## Accesorios ópticos Acessórios óticos



	Visera Viseira	Included	Included	Included	Included
-------------------------------------------------------------------------------------	-------------------	----------	----------	----------	----------





## Accesorios de fijación Acessórios de fixação

	Estaca de 235mm Estaca de 235 mm	<b>71-9997-05-05</b>	<b>71-9997-05-05</b>	<b>71-9997-05-05</b>	<b>71-9997-05-05</b>
	Estaca de 302mm Estaca de 302 mm	<b>71-9998-05-05</b>	<b>71-9998-05-05</b>	<b>71-9998-05-05</b>	<b>71-9998-05-05</b>
	Fijación para columnas o árboles Fixação para colunas ou árvores	<b>71-9999-Z5-Z5</b>	<b>71-9999-Z5-Z5</b>	<b>71-9999-Z5-Z5</b>	<b>71-9999-Z5-Z5</b>



	Cube Spotlight 1 LED S2	Cube Spotlight 1 LED	Cube Spotlight 4 LEDS	Cube Spotlight 4 LEDS RGBW
				

**Accesorios de fijación**  
**Acessórios de fixação**

	Anclaje (máx. 3 proyectores) Fixação (máx. 3 projetores)	71-9746-05-05	71-9746-05-05	71-9746-05-05	71-9746-05-05
	Alargador pared, suelo y césped (300/500/800mm) Extensão parede, chão e relva (300/500/800mm)	71-E052-Z5-Z5	71-E052-Z5-Z5	71-E052-Z5-Z5	71-E052-Z5-Z5
	Base para cables de Ø6mm - Ø13,5mm Base para cabos de Ø6mm - Ø13,5mm	71-E016-Z5-Z5	71-E016-Z5-Z5	71-E016-Z5-Z5	71-E016-Z5-Z5

	Cube Spotlight 9 LEDS	Cube Spotlight 9 LEDS RGBW	Cube Spotlight 16 LEDS	Cube Spotlight 16 LEDS RGBW
				







**Controladores**  
**Controladores** P. 1166

	Falta info driver	-	71-A238-00-00	-	71-A238-00-00
	DALI IP67	71-A237-00-00	-	71-A237-00-00	-

**Accesorios ópticos**  
**Acessórios óticos**

	Visera Viseira	Included	Included	Included	Included
-------------------------------------------------------------------------------------	-------------------	----------	----------	----------	----------

**Accesorios de fijación**  
**Acessórios de fixação**

	Estaca de 235mm Estaca de 235 mm	71-9997-05-05	71-9997-05-05	71-9997-05-05	71-9997-05-05
	Estaca de 302mm Estaca de 302 mm	71-9998-05-05	71-9998-05-05	71-9998-05-05	71-9998-05-05
	Fijación para columnas o árboles Fixação para colunas ou árvores	71-9999-Z5-Z5	71-9999-Z5-Z5	71-9999-Z5-Z5	71-9999-Z5-Z5
	Anclaje (máx. 3 proyectores) Fixação (máx. 3 projetores)	-	-	-	-
	Alargador pared, suelo y césped (300/500/800mm) Extensão parede, chão e relva (300/500/800mm)	-	-	-	-
	Base para cables de Ø6mm - Ø13,5mm Base para cabos de Ø6mm - Ø13,5mm	71-E016-Z5-Z5	71-E016-Z5-Z5	71-E016-Z5-Z5	71-E016-Z5-Z5

# Max

Designed by LedsC4 Architectural



+ Max

**FAMILIA / FAMILIA:** Downlights P.000. Uplights P.000. Wall Fixtures P.000. Ceiling P.000

## Equilibrio perfecto Equilíbrio perfeito

La colección Max ofrece una extensa variedad de opciones y un excelente control óptico sin renunciar al minimalismo. El reducido tamaño de los proyectores facilita su integración en la arquitectura, consiguiendo que pasen prácticamente desapercibidos, lo que los convierte en una opción muy demandada por los lighting designers más exigentes.

A coleção Max oferece uma grande variedade de opções e um excelente controle ótico sem sacrificar o minimalismo. O reduzido tamanho dos projetores facilita a sua integração na arquitetura, tornando-os praticamente imperceptíveis, o que os torna uma opção muito procurada pelos designers de iluminação mais exigentes.



82 mm



58 mm



30 mm



14



34



DL



E3



J6



Z5



60







# Max Spotlight

BODY MAT	DIF MAT		50000h	2
AL	GLA		L80 B20	MacAdam

FAMILIA/FAMÍLIA: Max Downlight P.XXX / Max Uplight P.XXX / Max Bollard P.XXX / Max Wall Fixture P.XXX / Max Ceiling P.XXX

## Max Mini Spotlight

	IP	IK		SEA SIDE SUITABLE		
	66	04	1m		180°	

Ejemplo de código / Exemplo de código: **BA18-P2V8S1BBZ5**

Model	W	K / Cri / Real lm	Optics	Source	Finishes	
 	Constant Current 700mA					
	<b>P2</b> 2.2W	<b>V8</b>	2700K / CRI 80 / 163 lm	<b>S1</b> 10°	<b>BB</b> 3V/max.700mA	<b>Z5</b> <b>14*</b> <b>34*</b> <b>60*</b> <b>DL*</b> <b>E3*</b> <b>J6*</b>
		<b>W8</b>	3000K / CRI 80 / 185 lm	<b>S2</b> 15°		
		<b>X8</b>	4000K / CRI 80 / 191 lm	<b>M3</b> 32° <b>F2</b> 53°		
	Constant Voltage 24V					
	<b>P3</b> 2.5W	<b>V8</b>	2700K / CRI 80 / 94 lm	<b>S3</b> 19°	<b>BB</b> 24VDC	
<b>W8</b>		3000K / CRI 80 / 97 lm	<b>M3</b> 32°			
<b>X8</b>		4000K / CRI 80 / 87 lm	<b>F2</b> 51°			

## Max Medium Spotlight

IP	IK		SEA SIDE SUITABLE		
66	10	1m		180°	

Ejemplo de código / Exemplo de código: **AI18-P4V9S1BBZ5**

Model	W	K / Cri / Real lm	Optics	Source	Finishes	
 	Constant Current 350mA					
	<b>P4</b> 4W	<b>V9</b>	2700K / CRI 90 / 286 lm	<b>S1</b> 9°	<b>BB</b> 12V/max.350mA	<b>Z5</b> <b>14*</b> <b>34*</b> <b>60*</b> <b>DL*</b> <b>E3*</b> <b>J6*</b>
		<b>W9</b>	3000K / CRI 90 / 286 lm			
		<b>X9</b>	4000K / CRI 90 / 286 lm			
	<b>P7</b> 6.5W	<b>V9</b>	2700K / CRI 90 / 519 lm	<b>S2</b> 17°	<b>BB</b> 18V/max.350mA	
		<b>W9</b>	3000K / CRI 90 / 459 lm	<b>M2</b> 27°		
		<b>X9</b>	4000K / CRI 90 / 423 lm	<b>F1</b> 50°		
	Constant Voltage 24V					
	<b>P6</b> 6W	<b>V9</b>	2700K / CRI 90 / 204 lm	<b>S1</b> 9°	<b>BB</b> 24VDC	
		<b>W9</b>	3000K / CRI 90 / 204 lm			
		<b>X9</b>	4000K / CRI 90 / 204 lm			
	<b>P8</b> 7.9W	<b>V9</b>	2700K / CRI 90 / 519 lm	<b>S2</b> 17°	<b>BB</b> 24VDC	
<b>W9</b>		3000K / CRI 90 / 459 lm	<b>M2</b> 27°			
<b>X9</b>		4000K / CRI 90 / 423 lm	<b>F1</b> 50°			

\* Consulte condiciones y plazos de entrega a nuestro equipo comercial.  
 \* Consultar a nossa equipa comercial para informações sobre as condições e os prazos de entrega.



# Max Big Spotlight



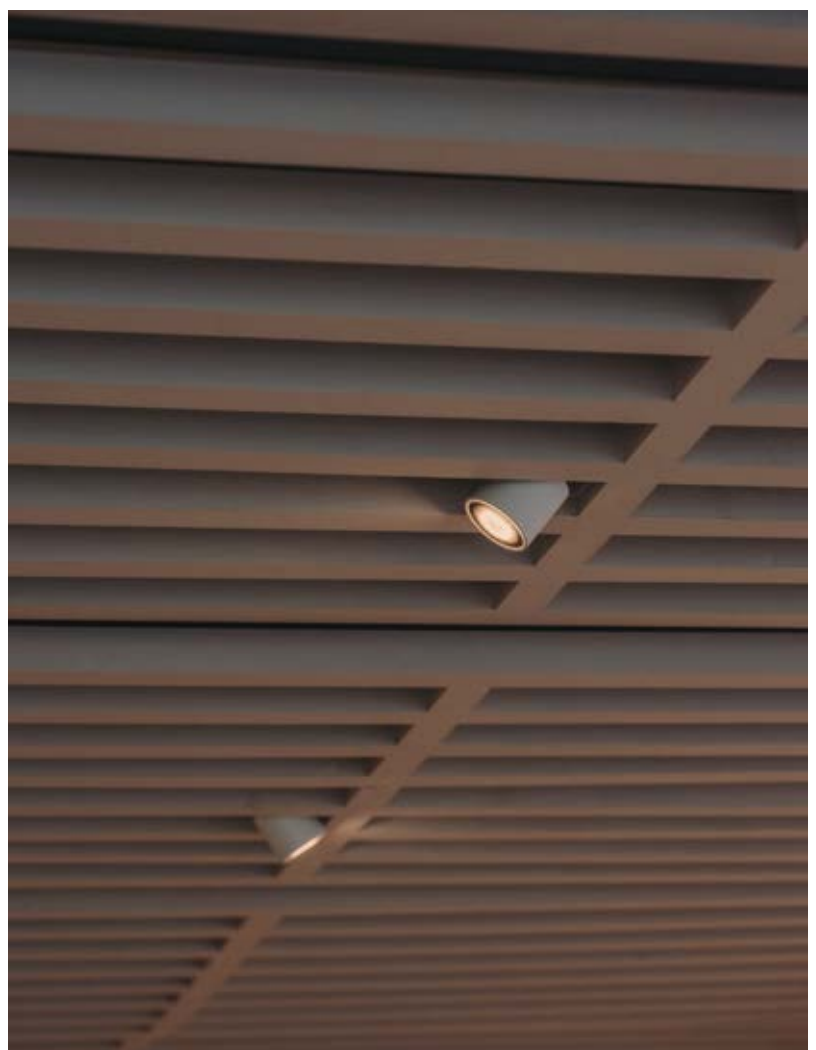

IP 66	IK 10	1 m	SEA SIDE SUITABLE	90°	LED
----------	----------	-----	----------------------	-----	-----

Ejemplo de código / Exemplo de código: **AT18-18V9S3BBZ5**

Model	W	K / Cri / Real lm	Optics	Source	Finishes	
 <p><b>AT18 -</b> Sin Soporte Sem suporte</p> 	Constant Current 500mA					
	<b>18</b> 17.3W	<b>V9</b>	2700K / CRI 90 / 1844 lm	<b>S3</b> 21°	<b>BB</b>  36V/max.500mA	<b>Z5</b>  <b>14*</b>  <b>34*</b>  <b>60*</b>  <b>DL*</b>  <b>E3*</b>  <b>J6*</b> 
		<b>W9</b>	3000K / CRI 90 / 2047 lm	<b>M3</b> 31°		
		<b>X9</b>	4000K / CRI 90 / 1803 lm	<b>F1</b> 40°		
	Constant Voltage 24V					
	<b>14</b> 13.8W	<b>V9</b>	2700K / CRI 90 / 1086 lm	<b>S3WA</b> 16°	<b>BB</b>  24VDC	
<b>W9</b>		3000K / CRI 90 / 1076 lm	<b>M2</b> 28°			
<b>X9</b>		4000K / CRI 90 / 1120 lm	<b>F2</b> 51°			





\* Consulte condiciones y plazos de entrega a nuestro equipo comercial.  
 \* Consultar a nossa equipa comercial para informações sobre as condições e os prazos de entrega.

	Max Mini Bollard Constant Current	Max Mini Bollard Constant Voltage	Max Medium Bollard Constant Current P4	Max Medium Bollard Constant Current
				



## Drivers Driver

P. 1166

	ON-OFF IP20	<b>71-3308-00-00</b> Min.1 - Max.7	-	<b>71-3542-00-00</b> Min.1 - Max.6	<b>71-3542-00-00</b> Min.1 - Max.4
	ON-OFF IP68	<b>71-E014-00-00</b> Min.1 - Max.4	-	<b>71-E079-00-00</b>  Min.1 - Max.4	<b>71-E079-00-00</b>  Min.1 - Max.2
	1-10V DALI2 IP68	-	-	<b>71-E083-00-00</b> Min.1 - Max.4	<b>71-E083-00-00</b> Min.1 - Max.2
	1-10V DALI2 PUSH IP20	-	-	<b>71-4706-00-00</b> Min.1 - Max.6	<b>71-4706-00-00</b> Min.1 - Max.4
	DALI2 IP20	<b>71-6192-00-00</b> Min.1 - Max.8	-	-	-
	DALI2 IP68	<b>71-E080-00-00</b> Min.1 - Max.14	-	-	-
	CASAMBI IP20	<b>71-A260-00-00</b> Min.4 - Max.15	-	<b>71-A260-00-00</b>  Min.1 - Max.4	<b>71-A260-00-00</b>  Min.1 - Max.2
	Not Dimmable IP20	<b>71-A654-00-00</b>  Min.1 - Max.1	-	-	-

## Fuentes de alimentación Fontes de alimentação

P. 1166

	ON-OFF IP67	-	<b>71-E158-00-00</b> Min.1 - Max.9	-	-
	DALI2 IP67	-	<b>71-E098-00-00</b> Min.1 - Max.20	-	-
	Fuente de alimentación estanca con conectores IP67 Fonte de alimentação estanque com conectores IP67	-	<b>71-E101-05-05</b> Min.1 - Max.7	-	-

## Controladores Controladores

P. 1166

	CASAMBI IP67	-	<b>71-A242-00-00</b> Min.1 - Max.20	-	-
-------------------------------------------------------------------------------------	-----------------	---	----------------------------------------	---	---

Max Medium Bollard Constant Voltage P6      Max Medium Bollard Constant Voltage      Max Big Bollard Constant Current      Max Big Bollard Constant Voltage



**Drivers** P. 1166  
**Driver**

	ON-OFF IP20	-	-	<b>71-3542-00-00</b> Min.1 - Max.2	-
	ON-OFF IP68	-	-	<b>71-E079-00-00</b> Min.1 - Max.1	-
	1-10V DALI2 IP68	-	-	<b>71-E083-00-00</b> Min.1 - Max.1	-
	1-10V DALI2 PUSH IP20	-	-	<b>71-4706-00-00</b> Min.1 - Max.2	-
	DALI2 IP20	-	-	-	-
	DALI2 IP68	-	-	-	-
	CASAMBI IP20	-	-	<b>71-A260-00-00</b> Min.1 - Max.1	-
	Not Dimmable IP20	-	-	-	-

**Fuentes de alimentación** P. 1166  
**Fontes de alimentação**

	ON-OFF IP67	<b>71-E159-00-00</b> Min.1 - Max.9	<b>71-E159-00-00</b> Min.1 - Max.7	-	<b>71-6341-00-00</b> Min.1 - Max.7
	DALI2 IP67	<b>71-E098-00-00</b> Min.1 - Max.9	<b>71-E098-00-00</b> Min.1 - Max.7	-	<b>71-E099-00-00</b> Min.1 - Max.8
	Fuente de alimentación estanca con conectores IP67 Fonte de alimentação estanque com conectores IP67	<b>71-E101-05-05</b> Min.1 - Max.3	<b>71-E101-05-05</b> Min.1 - Max.2	-	<b>71-E101-05-05</b> Min.1 - Max.1

**Controladores** P. 1166  
**Controladores**

	CASAMBI IP67	<b>71-A242-00-00</b> Min.4 - Max.15	<b>71-A242-00-00</b> Min.4 - Max.12	-	<b>71-A242-00-00</b> Min.1 - Max.8
--	-----------------	----------------------------------------	----------------------------------------	---	---------------------------------------

Max Mini Bollard  
Constant Current



Max Mini Bollard  
Constant Voltage



Max Medium  
Bollard Constant  
Current P4



Max Medium  
Bollard Constant  
Current



**Accesorios ópticos**  
**Acessórios óticos**



Panel de abeja (5u.)  
Painel de abelha (5u.)

71-E422-00-00

71-E422-00-00

71-E131-00-00

71-E131-00-00



Difusor cuadrado (5u.)  
Difusor quadrado (5u.)

71-E421-00-00

71-E421-00-00

71-E135-00-00

71-E135-00-00



Difusor elíptico (5u.)  
Difusor elíptico (5u.)

71-E420-00-00

71-E420-00-00

71-E141-00-00

71-E141-00-00

Difusor opal (5u.)  
Difusor opal (5u.)

71-E419-00-00

71-E419-00-00

71-E133-00-00

71-E133-00-00

Difusor wall washer (5u.)  
Wall washer diffuser (5u.)

71-E462-00-00

71-E462-00-00

71-E463-00-00

71-E463-00-00

Visera  
Viseira

Z5 ●

71-E417-J6-00

71-E417-J6-00

71-E145-Z5-Z5

71-E145-Z5-Z5

J6 ● \*

71-E417-J6-00

71-E417-J6-00

71-E145-J6-J6

71-E145-J6-J6

E3 ● \*

71-E417-J6-00

71-E417-J6-00

71-E145-E3-E3

71-E145-E3-E3

DL ● \*

71-E417-J6-00

71-E417-J6-00

71-E145-DL-DL

71-E145-DL-DL

14 ○ \*

71-E417-J6-00

71-E417-J6-00

71-E145-14-14

71-E145-14-14

60 ● \*

71-E417-J6-00

71-E417-J6-00

71-E145-60-60

71-E145-60-60

34 ● \*

71-E417-J6-00

71-E417-J6-00

71-E145-34-34





71-E145-34-34

71-E417-J6-00











71-E417-J6-00

-



-

	<b>Max Medium Bollard Constant Voltage P6</b>	<b>Max Medium Bollard Constant Voltage</b>	<b>Max Big Bollard Constant Current</b>	<b>Max Big Bollard Constant Voltage</b>
				

**Accesorios ópticos**  
**Acessórios óticos**

	Panel de abeja (5u.) Painel de abelha (5u.)	<b>71-E131-00-00</b>	<b>71-E131-00-00</b>	<b>71-E263-00-00</b>	<b>71-E263-00-00</b>
	Difusor cuadrado (5u.) Difusor quadrado (5u.)	<b>71-E135-00-00</b>	<b>71-E135-00-00</b>	<b>71-E262-00-00</b>	<b>71-E262-00-00</b>
	Difusor elíptico (5u.) Difusor elíptico (5u.)	<b>71-E141-00-00</b>	<b>71-E141-00-00</b>	<b>71-E261-00-00</b>	<b>71-E261-00-00</b>
	Difusor opal (5u.) Difusor opal (5u.)	<b>71-E133-00-00</b>	<b>71-E133-00-00</b>	<b>71-E260-00-00</b>	<b>71-E260-00-00</b>
	Difusor wall washer (5u.) Wall washer diffuser (5u.)	<b>71-E463-00-00</b>	<b>71-E463-00-00</b>	<b>71-E464-00-00</b>	<b>71-E464-00-00</b>
Visera Viseira	<b>Z5</b> 	<b>71-E145-Z5-Z5</b>	<b>71-E145-Z5-Z5</b>	<b>71-E259-Z5-00</b>	<b>71-E259-Z5-00</b>
	<b>J6</b>  *	<b>71-E145-J6-J6</b>	<b>71-E145-J6-J6</b>	<b>71-E259-J6-00</b>	<b>71-E259-J6-00</b>
	<b>E3</b>  *	<b>71-E145-E3-E3</b>	<b>71-E145-E3-E3</b>	<b>71-E259-E3-00</b>	<b>71-E259-E3-00</b>
	<b>DL</b>  *	<b>71-E145-DL-DL</b>	<b>71-E145-DL-DL</b>	<b>71-E259-DL-00</b>	<b>71-E259-DL-00</b>
	<b>14</b>  *	<b>71-E145-14-14</b>	<b>71-E145-14-14</b>	<b>71-E259-14-00</b>	<b>71-E259-14-00</b>
	<b>60</b>  *	<b>71-E145-60-60</b>	<b>71-E145-60-60</b>	<b>71-E259-60-00</b>	<b>71-E259-60-00</b>
	<b>34</b>  *	<b>71-E145-34-34</b>	<b>71-E145-34-34</b>	<b>71-E259-34-00</b>	<b>71-E259-34-00</b>
		-	-	-	-

**Accesorios de fijación**  
**Acessórios de fixação**

	Estaca de 302mm Estaca de 302 mm	-	-	<b>71-9998-05-05</b>	<b>71-9998-05-05</b>
	Estaca de 235mm Estaca de 235 mm	-	-	<b>71-9997-05-05</b>	<b>71-9997-05-05</b>

# Modis

Designed by Luca Turrini



+ Modis

**FAMILIA/FAMILIA:** Wall Fixtures P.000. Ceilings P.000. Bollards P.000. Lampost P.000

## Libertad total de movimiento Total liberdade de movimento

El proyector Modis dirige el haz de luz hacia el objeto a iluminar con precisión, gracias a la rotación de su cabezal, y con gran una uniformidad, realzando tanto la vegetación como la arquitectura del ambiente en el que se encuentra.

O projetor Modis direciona o feixe de luz para o objeto a iluminar com precisão, graças à rotação da sua cabeça, e com grande uniformidade, realçando tanto a vegetação como a arquitetura do ambiente onde se encontra.



14

34

DL

E3

J6

Z5

60







PROYECTORES



# Modis Spotlight

BODY MAT	DIF MAT		50000h	3
AL	GLA		L80 B20	MacAdam

FAMILIA/FAMÍLIA: Modis Bollard P.XXX / Modis Wall, Ceiling & Spotlight P.XXX / Modis Wall, Ceiling & Spotlight P.XXX

## Modis Opal Single

IP	IK	SWITCH CCT		SEA SIDE				
66	10	SW 2700-3200-4000		SUITABLE				

Z5 14\* 60\* 34\* J6\* E3\* DL\*

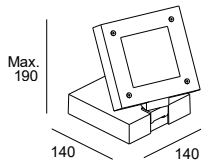

LED						
K	CRI	W Total	Real Lm	Optics	Code	
						Z5
						J6
SW 2700-3200-4000	80	13.2	744	107°	05-E062	E3 OU ON-OFF 100-277V
						DL - DU DALI-2 100-277V
						14 XB CASAMBI 220-240V
						60
						34

El flujo indicado corresponde a la temperatura central.  
O fluxo indicado corresponde a temperatura central.

## Modis Opal Double 430mm

IP	IK	BREEAM	SWITCH CCT		SEA SIDE				
66	10		SW 2700-3200-4000		SUITABLE				

Z5 14\* 60\* 34\* J6\* E3\* DL\*

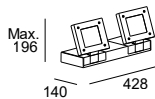

LED						
K	CRI	W Total	Real Lm	Optics	Code	
						Z5
						J6
SW 2700-3200-4000	80	2 x 13.2	1488	107°	05-E063	E3 OU ON-OFF 100-277V
						DL - DU DALI-2 100-277V
						14 XB CASAMBI 220-240V
						60
						34

El flujo indicado corresponde a la temperatura central.  
O fluxo indicado corresponde a temperatura central.

## Modis Opal Double 800mm

IP	IK	BREEAM	SWITCH CCT		SEA SIDE				
66	10		SW 2700-3200-4000		SUITABLE				

Z5 14\* 60\* 34\* J6\* E3\* DL\*

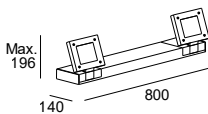

LED						
K	CRI	W Total	Real Lm	Optics	Code	
						Z5
						J6
SW 2700-3200-4000	80	2 x 13.2	1488	107°	05-E064	E3 OU ON-OFF 100-277V
						DL - DU DALI-2 100-277V
						14 XB CASAMBI 220-240V
						60
						34

El flujo indicado corresponde a la temperatura central.  
O fluxo indicado corresponde a temperatura central.

## Modis Optics Double 800mm



Ejemplo de código / Exemplo de código: **AS13-37V9S30UZ5**

Model	W	K / Cri / Real lm	Optics	Source	Finishes
<b>AS13 -</b> ↻350° ↻180° 	<b>37</b> 2 x 20W	<b>V9</b> 2700K / CRI 90 / 3360 lm	<b>S3</b> 16°	<b>OU</b> ON-OFF 100-277V	<b>Z5</b> <b>14*</b> <b>60*</b> <b>34*</b> <b>J6*</b> <b>E3*</b> <b>DL*</b>
		<b>W9</b> 3000K / CRI 90 / 3828 lm	<b>M3</b> 38°	<b>DS</b> DALI-2/PUSH 220-240V	
		<b>X9</b> 4000K / CRI 90 / 3932 lm	<b>F1</b> 48°	<b>XB</b> CASAMBI 220-240V	

## Modis Optics Double 430mm



Ejemplo de código / Exemplo de código: **AS12-37V9S30UZ5**

Model	W	K / Cri / Real lm	Optics	Source	Finishes
<b>AS12 -</b> ↻350° ↻180° 	<b>37</b> 2 x 20W	<b>V9</b> 2700K / CRI 90 / 3360 lm	<b>S3</b> 16°	<b>OU</b> ON-OFF 100-277V	<b>Z5</b> <b>14*</b> <b>60*</b> <b>34*</b> <b>J6*</b> <b>E3*</b> <b>DL*</b>
		<b>W9</b> 3000K / CRI 90 / 3828 lm	<b>M3</b> 38°	<b>DS</b> DALI-2/PUSH 220-240V	
		<b>X9</b> 4000K / CRI 90 / 3932 lm	<b>F1</b> 48°	<b>XB</b> CASAMBI 220-240V	

## Modis Optics Simple



Ejemplo de código / Exemplo de código: **AS11-18V9S30UZ5**

Model	W	K / Cri / Real lm	Optics	Source	Finishes
<b>AS11 -</b> ↻350° ↻180° 	<b>18</b> 20W	<b>V9</b> 2700K / CRI 90 / 1680 lm	<b>S3</b> 16°	<b>OU</b> ON-OFF 100-277V	<b>Z5</b> <b>14*</b> <b>60*</b> <b>34*</b> <b>J6*</b> <b>E3*</b> <b>DL*</b>
		<b>W9</b> 3000K / CRI 90 / 1914 lm	<b>M3</b> 38°	<b>DS</b> DALI-2/PUSH 220-240V	
		<b>X9</b> 4000K / CRI 90 / 1966 lm	<b>F1</b> 48°	<b>XB</b> CASAMBI 220-240V	

\* Consulte condiciones y plazos de entrega a nuestro equipo comercial.  
 \* Consultar a nossa equipa comercial para informações sobre as condições e os prazos de entrega.

## Modis Opal Single

Modis Opal  
Double 430mmModis Opal  
Double 800mm**Accesorios ópticos**  
Acessórios óticosVisera  
Viseira

Z5 ●	71-E234-Z5-00	71-E234-Z5-00	71-E234-Z5-00
J6 ● *	71-E234-J6-00	71-E234-J6-00	71-E234-J6-00
E3 ● *	71-E234-E3-00	71-E234-E3-00	71-E234-E3-00
DL ● *	71-E234-DL-00	71-E234-DL-00	71-E234-DL-00
14 ○ *	71-E234-14-00	71-E234-14-00	71-E234-14-00
60 ● *	71-E234-60-00	71-E234-60-00	71-E234-60-00
34 ○ *	71-E234-34-00	71-E234-34-00	71-E234-34-00

**Accesorios de fijación**  
Acessórios de fixaçãoEstaca de 302mm  
Estaca de 302 mm

71-9998-05-05

-

-

Estaca de 235mm  
Estaca de 235 mm

71-9997-05-05

-

-

**Accesorios de unión**  
Acessórios de uniãoPlaca concatenadora  
Placa de união

Z5 ●	-	71-E235-Z5-00	71-E235-Z5-00
J6 ● *	-	71-E235-J6-00	71-E235-J6-00
E3 ● *	-	71-E235-E3-00	71-E235-E3-00
DL ● *	-	71-E235-DL-00	71-E235-DL-00
14 ○ *	-	71-E235-14-00	71-E235-14-00
60 ● *	-	71-E235-60-00	71-E235-60-00
34 ○ *	-	71-E235-34-00	71-E235-34-00

Atom Track 52 LED Driver Zoom    Atom Track 75 LED Driver    Atom Track 75 LED Driver Zoom    Atom Track 97 LED Driver









**Controladores** P. 1166  
Controladores

	DALI	14 ○	-	<b>71-A243-14-14</b>	-	<b>71-A243-14-14</b>
		60 ●	-	<b>71-A243-60-60</b>	-	<b>71-A243-60-60</b>

**Sensores** P. 1166  
Sensores

	Multisensor a carril trifasico Multissensor para calha trifásica	14 ○	-	<b>35-A075-14-00</b>	-	<b>35-A075-14-00</b>
		60 ●	-	<b>35-A075-60-00</b>	-	<b>35-A075-60-00</b>

**Accesorios ópticos**  
Acessórios óticos

	Difusor elíptico (5u.) Difusor elíptico (5u.)		-	<b>71-6280-00-00</b>	<b>71-6280-00-00</b>	<b>71-6286-00-00</b>
	Difuminador de halo (5u.) Difusor opalino (5u.)		-	<b>71-6281-00-00</b>	<b>71-6281-00-00</b>	<b>71-6287-00-00</b>
	Conforto visual (1u.) Conforto visual (1u.)	14 ○	-	<b>71-6282-14-00</b>	<b>71-6282-14-00</b>	<b>71-6288-14-00</b>
		60 ●	-	<b>71-6282-60-00</b>	<b>71-6282-60-00</b>	<b>71-6288-60-00</b>
	Panel de abeja (5u.) Painel de abelha (5u.)		-	<b>71-6279-60-00</b>	<b>71-6279-60-00</b>	<b>71-6285-60-00</b>
	Visera Viseira		-	<b>71-6283-60-00</b>	<b>71-6283-60-00</b>	<b>71-6289-60-00</b>
	Aletas antideslumbrantes Abas antideslumbramento	14 ○	-	-	-	<b>71-6290-14-00</b>
		60 ●	-	-	-	<b>71-6290-60-00</b>
	Aro frontal Aro frontal	14 ○	-	<b>71-6437-14-00</b>	<b>71-6437-14-00</b>	<b>71-6438-14-00</b>
		23 ●	-	<b>71-6437-23-00</b>	<b>71-6437-23-00</b>	<b>71-6438-23-00</b>

# Hubble

by Francesc Vilaró



+ Hubble

## Máxima polivalencia Máxima versatilidade

La variedad de materiales, fuentes de luz y múltiples accesorios convierten a Hubble en la colección más polivalente del catálogo. Ideada para iluminar desde jardines privados hasta grandes áreas de uso público ya que puede alcanzar hasta 10.000 lúmenes reales.

A variedade de materiais, fontes de luz e múltiplos acessórios fazem de Hubble a coleção mais versátil do catálogo. Concebida para iluminar desde jardins privados a grandes áreas públicas, uma vez que pode atingir até 10.000 lúmenes reais.



## Instalaciones Instalações

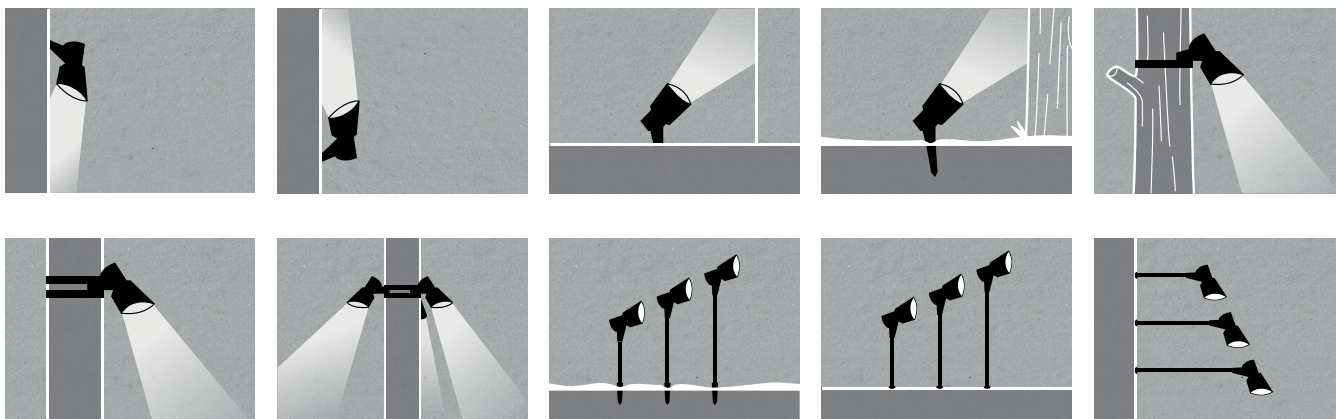

**Hubble Cob**

**642**

Solución LED altamente versátil  
 Solução LED altamente versátil

Ø 126 mm



●  
Z5

**Hubble GU10  
 Aluminium**

**646**

Solución GU10 ideal para superficies  
 rígidas vistas  
 Solução GU10 ideal para superficies  
 rígidas expostas

Ø 120 mm



○ ● ●  
14 Z5 34

**Hubble GU10  
 Technopolymer**

**648**

Solución GU10 ideal para clavar  
 en el césped  
 Solução GU10 ideal para  
 cravar na relva

Ø 120 mm



●  
05

Ø 175 mm



●  
Z5

Ø 207 mm



●  
Z5

Ø 234 mm



●  
Z5

11,5 - 92 W



S - F

**S:** Spot (18°) **F:** Flood (34°)

# Hubble Cob



Solución LED  
altamente versátil  
Solução LED  
altamente versátil

## Efectos de luz Efeitos de luz



Con reflector de 10°  
Com refletor 10°



Con reflector de 33°  
Com refletor 33°

Reflector de 10°  
Refletor 10°

Reflector de 33°  
Refletor 33°

Antideslumbrante  
Antiencadeamento







Proyecto Son Rich Residences, Begur. Hubble Cob Ø175mm.  
Projeto Son Rich Residences da Begur. Hubble Cob modelo ø175mm.

# Hubble Cob

BODY MAT
POLI

DIF MAT
GLA



## Hubble Cob 126mm

IP	IK	BREEAM	50000h	3	SEA SIDE SUITABLE	±90°	LED	DRIVER
65	07		L80 B20	MacAdam				

Z5

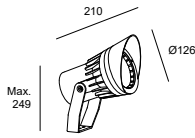

LED							
K	CRI	W Total	Real Lm	Optics	Code		
2700	80	13	1167	11°;38°	<b>05-9989 - Z5 - CK</b>	ON-OFF 100-240V	
3000	80	13	1167	11°;38°	<b>05-9989 - Z5 - CL</b>	ON-OFF 100-240V	
4000	80	13	1251	11°;38°	<b>05-9989 - Z5 - CM</b>	ON-OFF 100-240V	

## Hubble Cob 175mm

IP	IK	50000h	BREEAM	3	SEA SIDE SUITABLE	±90°	LED	DRIVER
65	08	L80 B20		MacAdam				

Z5

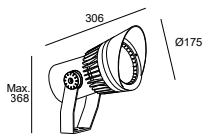
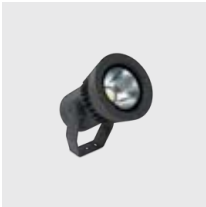

LED							
K	CRI	W Total	Real Lm	Optics	Code		
2700	80	35.2	3589	16°;39°	<b>05-9959 - Z5 - CK</b>	ON-OFF 100-240V	
3000	80	35.2	3589	16°;39°	<b>05-9959 - Z5 - CL</b>	ON-OFF 100-240V	
4000	80	35.2	3804	16°;39°	<b>05-9959 - Z5 - CM</b>	ON-OFF 100-240V	

## Hubble Cob 207mm

IP	IK	BREEAM	50000h	3	SEA SIDE SUITABLE	±90°	LED	DRIVER
65	08		L80 B20	MacAdam				

Z5

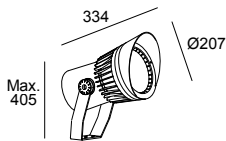
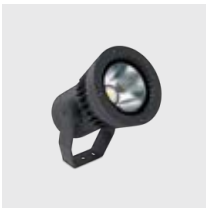

LED							
K	CRI	W Total	Real Lm	Optics	Code		
2700	80	56.4	5266	16°;39°	<b>05-9960 - Z5 - CK</b>	ON-OFF 120-277V	
3000	80	56.4	5631	16°;39°	<b>05-9960 - Z5 - CL</b>	ON-OFF 120-277V	
4000	80	56.4	5631	16°;39°	<b>05-9960 - Z5 - CM</b>	ON-OFF 120-277V	



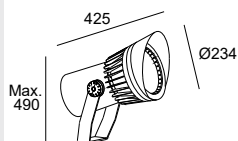
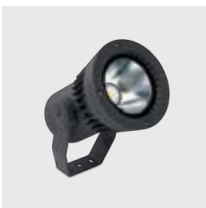

## Hubble Cob 234mm

IP	IK	LOW FLICKER	50000h	BREEAM	3	±90°	(SC)
66	09		L80 B20		MacAdam		

Z5



LED							
K	CRI	W Total	Real Lm	Optics	Code		
2700	80	96.8	9931	20°;44°	<b>05-E083 - Z5 - CK</b>	DALI 220-240V	
3000	80	96.8	10552	20°;44°	<b>05-E083 - Z5 - CL</b>	DALI 220-240V	
4000	80	96.8	10863	20°;44°	<b>05-E083 - Z5 - CM</b>	DALI 220-240V	

	Hubble Cob 126mm	Hubble Cob 175mm	Hubble Cob 207mm	Hubble Cob 234mm
				







**Controladores** P. 1166  
Controladores

	DALI IP67	-	-	-	<b>71-A237-00-00</b>
-----------------------------------------------------------------------------------	--------------	---	---	---	----------------------

**Accesorios ópticos**  
Acessórios óticos

	Antideslumbrante Antideslumbramento	Included	Included	Included	-
	Visera Viseira	Included	Included	Included	Included
	Set de 2 reflectores (11° y 38°) Set de 2 refletores (11° e 38°)	Included	-	-	-
	Set de 2 reflectores (16° y 39°) Set de 2 refletores (16° e 39°)	-	Included	Included	-
	Set de 2 reflectores (20° y 44°) Set de 2 refletores (20° e 44°)	-	-	-	Included

**Accesorios de fijación**  
Acessórios de fixação

	Estaca de 302mm Estaca de 302 mm	<b>71-9998-05-05</b>	<b>71-9998-05-05</b>	<b>71-9998-05-05</b>	<b>71-9998-05-05</b>
	Estaca de 235mm Estaca de 235 mm	<b>71-9997-05-05</b>	<b>71-9997-05-05</b>	<b>71-9997-05-05</b>	<b>71-9997-05-05</b>
	Fijación para columnas Fixação para colunas	-	-	<b>71-E058-Z5-00</b>	<b>71-E058-Z5-00</b>
	Fijación para columnas o árboles Fixação para colunas ou árvores	<b>71-9999-Z5-Z5</b>	<b>71-9999-Z5-Z5</b>	-	-
	Anclaje (máx. 3 proyectores) Fixação (máx. 3 projetores)	<b>71-9746-05-05</b>	-	-	-
	Alargador pared, suelo y césped (300/500/800mm) Extensão parede, chão e relva (300/500/800mm)	<b>71-E052-Z5-Z5</b>	<b>71-E052-Z5-Z5</b>	-	-
	Base para cables de Ø6mm - Ø13,5mm Base para cabos de Ø6mm - Ø13,5mm	<b>71-E016-Z5-Z5</b>	<b>71-E016-Z5-Z5</b>	<b>71-E016-Z5-Z5</b>	<b>71-E016-Z5-Z5</b>

# Hubble GU10 Aluminium



Solución GU10 ideal para superficies rígidas vistas  
Solução GU10 ideal para superfícies rígidas expostas

## Variedad de acabados

Variedade de acabamentos



### Hubble GU10 Aluminium

IP	IK	SEA SIDE SUITABLE	±90°
65	06		

● ○ ●  
Z5 14 34

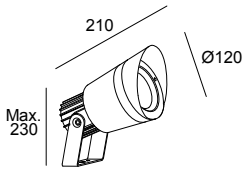

GU10	<b>Code</b>
<b>W</b>	<b>Z5</b>
Max. 8	<b>05-9416 - 14 - 37</b>
	<b>34</b>

### Accesorios ópticos Acessórios óticos



Visera  
Viseira

Included

### Accesorios de fijación Acessórios de fixação



Estaca de 235mm  
Estaca de 235 mm

**71-9997-05-05**



Estaca de 302mm  
Estaca de 302 mm

**71-9998-05-05**



Fijación para columnas o árboles  
Fixação para colunas ou árvores

**71-9999-Z5-Z5**



Anclaje (máx. 3 proyectores)  
Fixação (máx. 3 projetores)

**71-9746-05-05**



Alargador pared, suelo y césped (300/500/800mm)  
Extensão parede, chão e relva (300/500/800mm)

Z5 ●

**71-E052-Z5-Z5**

34 ●

**71-E052-34-34**



Base para cables de Ø6mm - Ø13,5mm  
Base para cabos de Ø6mm - Ø13,5mm

**71-E016-Z5-Z5**

---

# Hubble GU10 Technopolymer

---



Solución GU10 ideal para  
clavar en el césped

Solução GU10 ideal para  
cravar na relva

Indicada para zonas permanentemente  
húmedas o instalaciones a bajo voltaje.

Indicada para zonas permanentemente húmidas  
ou instalações de baixa tensão.



---

100% fabricada en  
tecno-polímero  
ultra resistente  
100% fabricada em  
tecno-polímero  
ultrarresistente



### Hubble GU10&GU5.3 Technopolymer

IP
66

IK
06

SEA SIDE
SUITABLE

±90°
------

05

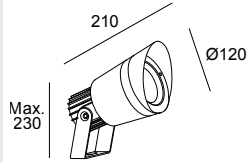

GU10	
<b>W</b>	<b>Code</b>
Max. 8	<b>05-9722 - 05 - 37</b>

### Accesorios ópticos

#### Acessórios óticos



Visera  
Viseira

Included



Portalámparas GU5.3  
Casquilho GU5.3

Included

### Accesorios de fijación

#### Acessórios de fixação



Estaca  
Estaca

Included



Estaca de 302mm  
Estaca de 302 mm

71-9998-05-05



Estaca de 235mm  
Estaca de 235 mm

71-9997-05-05



Fijación para columnas o árboles  
Fixação para colunas ou árvores

71-9999-Z5-Z5



Anclaje (máx. 3 proyectores)  
Fixação (máx. 3 projetores)

71-9746-05-05



Base para cables de Ø6mm - Ø13,5mm  
Base para cabos de Ø6mm - Ø13,5mm

71-E016-Z5-Z5



# Thor

Designed by LedsC4 Architectural



+ Thor

Emocionante de noche.  
Espectacular de día  
Emocionante de noite.  
Espetacular de dia

La pureza del acero inoxidable ofrece un porte indiscutible, que se aprecia a simple vista de día y se intuye de noche. Thor realiza la majestuosidad de los espacios nocturnos con una iluminación regulable y controlada y se integra en el ambiente de día gracias a una silueta purista trabajada al detalle.

A pureza do aço inoxidável oferece um porte indiscutível que pode ser visto de dia e sentido de noite. Thor realça a majestuosidade dos espaços noturnos com uma iluminação regulável e controlada e integra-se no ambiente de dia graças a uma silhueta purista trabalhada ao pormenor.



Ø72 mm

Ø50 mm

Ø26 mm



Ópticas  
Óticas

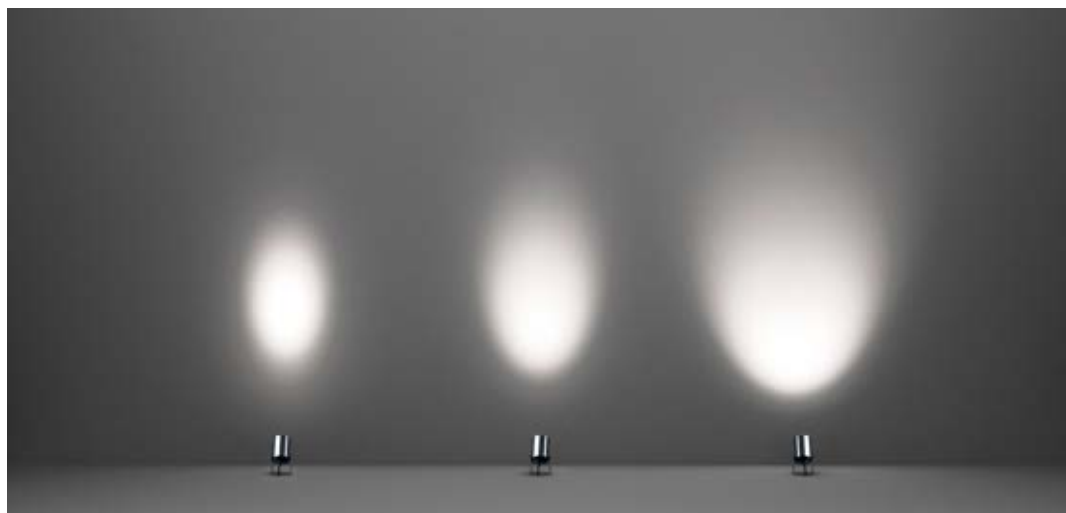

14° (05-E009-CA-CL)/26° (05-E153-CA-CL)/ 49° (05-E010-CA-CL)







# Thor

BODY MAT AISI316	DIF MAT GLA		50000h L80 B20	2 MacAdam
---------------------	----------------	--	-------------------	--------------

## Thor ø26

IP 66	IK 02	BREEAM	 2 m	SEA SIDE SUITABLE	 90°		
----------	----------	--------	---------	----------------------	---------	--	--

●  
CA

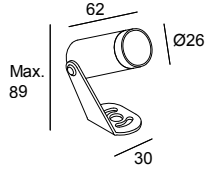

LED						24-48 VDC
K	CRI	W	Real Lm	Optics	Code	
3000	80	2	154	19°	<b>05-E007</b>	
3000	80	2	138	52°	<b>05-E008 - CA - CL</b>	
3000	80	2	169	33°	<b>05-E152</b>	

## Thor ø50

IP 66	IK 02	BREEAM	 2 m	SEA SIDE SUITABLE	 90°		
----------	----------	--------	---------	----------------------	---------	--	--

●  
CA

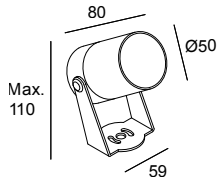

LED						24-48 VDC
K	CRI	W	Real Lm	Optics	Code	
3000	80	4.5	290	14°	<b>05-E009</b>	
3000	80	4.5	352	48°	<b>05-E010 - CA - CL</b>	
3000	80	4.5	341	26°	<b>05-E153</b>	



## Thor ø72

IP 66	IK 05	BREEAM	 2 m	SEA SIDE SUITABLE	 90°			
----------	----------	--------	---------	----------------------	---------	--	--	--

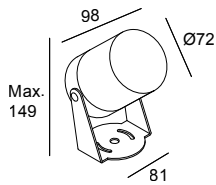









●  
CA



LED						24VDC
K	CRI	W	Real Lm	Optics	Code	
3000	80	8.4	758	16°	<b>05-E011</b>	
3000	80	8.4	812	52°	<b>05-E013 - CA - CL</b>	
3000	80	8.4	675	29°	<b>05-E154</b>	

	<b>Thor ø26</b>	<b>Thor ø50</b>	<b>Thor ø72</b>
			



**Fuentes de alimentación**  
**Fontes de alimentação** P. 1166

	ON-OFF IP67	<b>71-E159-00-00</b>  Min.1 - Max.13	<b>71-E159-00-00</b>  Min.1 - Max.11	<b>71-6341-00-00</b>  Min.1 - Max.9
	DALI2 IP67	-	-	<b>71-E099-00-00</b>  Min.1 - Max.12
	Fuente de alimentación estanca con conectores IP67 Fonte de alimentação estanque com conectores IP67	<b>71-E101-05-05</b>  Min.1 - Max.4	<b>71-E101-05-05</b>  Min.1 - Max.4	<b>71-E101-05-05</b>  Min.1 - Max.2



**Controladores**  
**Controladores** P. 1166

	CASAMBI IP67	-	-	<b>71-A242-00-00</b>  Min.1 - Max.12
-----------------------------------------------------------------------------------	-----------------	---	---	----------------------------------------------------------------------------------------------------------------------------

**Accesorios de fijación**  
**Acessórios de fixação**

	Estaca Estaca	<b>71-E143-05-05</b>	<b>71-E143-05-05</b>	-
	Estaca de 302mm Estaca de 302 mm	-	-	<b>71-9998-05-05</b>
	Estaca de 235mm Estaca de 235 mm	-	-	<b>71-9997-05-05</b>

**Accesorios de conexión**  
**Acessórios de conexão**

	Conector anticondensación IP68 (1 entrada + 1 salida) Ø 5,5 - 12mm, 4 polos Conetor anticondensação IP68 (1 entrada + 1 saída) Ø 5,5 - 12 mm, 4 polos	<b>71-E112-00-00</b>	<b>71-E112-00-00</b>	<b>71-E112-00-00</b>
	Conector anticondensación IP68 (1 entrada + 3 salidas) Ø 5,5 - 12mm, 4 polos Conetor anticondensação IP68 (1 entrada + 3 saídas) Ø 5,5 - 12 mm, 4 polos	<b>71-E122-00-00</b>	<b>71-E122-00-00</b>	<b>71-E122-00-00</b>
	Caja de conexión IP67 (1 entrada + 2 salidas) Ø 6 - 7,5mm, 3 polos Caixa de ligação IP67 (1 entrada + 2 saídas) Ø 6 - 7,5 mm, 3 polos	<b>71-9262-05-05</b>	<b>71-9262-05-05</b>	<b>71-9262-05-05</b>
	Caja de conexión IP68 (1 entrada + 5 salidas) Ø 6,5 - 11mm, 6 polos Caixa de ligação IP68 (1 entrada + 5 saídas) Ø 6,5 - 11 mm, 6 polos	<b>71-9199-05-05</b>	<b>71-9199-05-05</b>	<b>71-9199-05-05</b>

# Micro



Un buen proyecto de paisajismo debe completarse con una iluminación adecuada, que responda al reto de integración en plantas y arbustos. Micro es la solución ideal para iluminar con calidez y de forma controlada todo tipo de vegetación con poca altura.

Um bom projeto paisagístico deve ser completado com uma iluminação adequada que responda ao desafio de integração nas plantas e arbustos. Micro é a solução ideal para iluminar com calidez e de forma controlada todo o tipo de vegetação com pouca altura.

Iluminación integrada  
en arbustos  
Iluminação integrada  
em arbustos



## Accesorios ópticos incluidos Acessórios óticos incluídos



Visera  
Viseira



Reflector 15°  
Refletor 15°



Filtro verde  
Filtro verde



Filtro amarillo  
Filtro amarelo



Filtro difusor  
Filtro difusor



Reflector 38°  
Refletor 38°



Se integra a la perfección entre elementos naturales de una zona exterior.

Integra-se na perfeição entre os elementos naturais de uma zona exterior.

Instalaciones  
Instalações

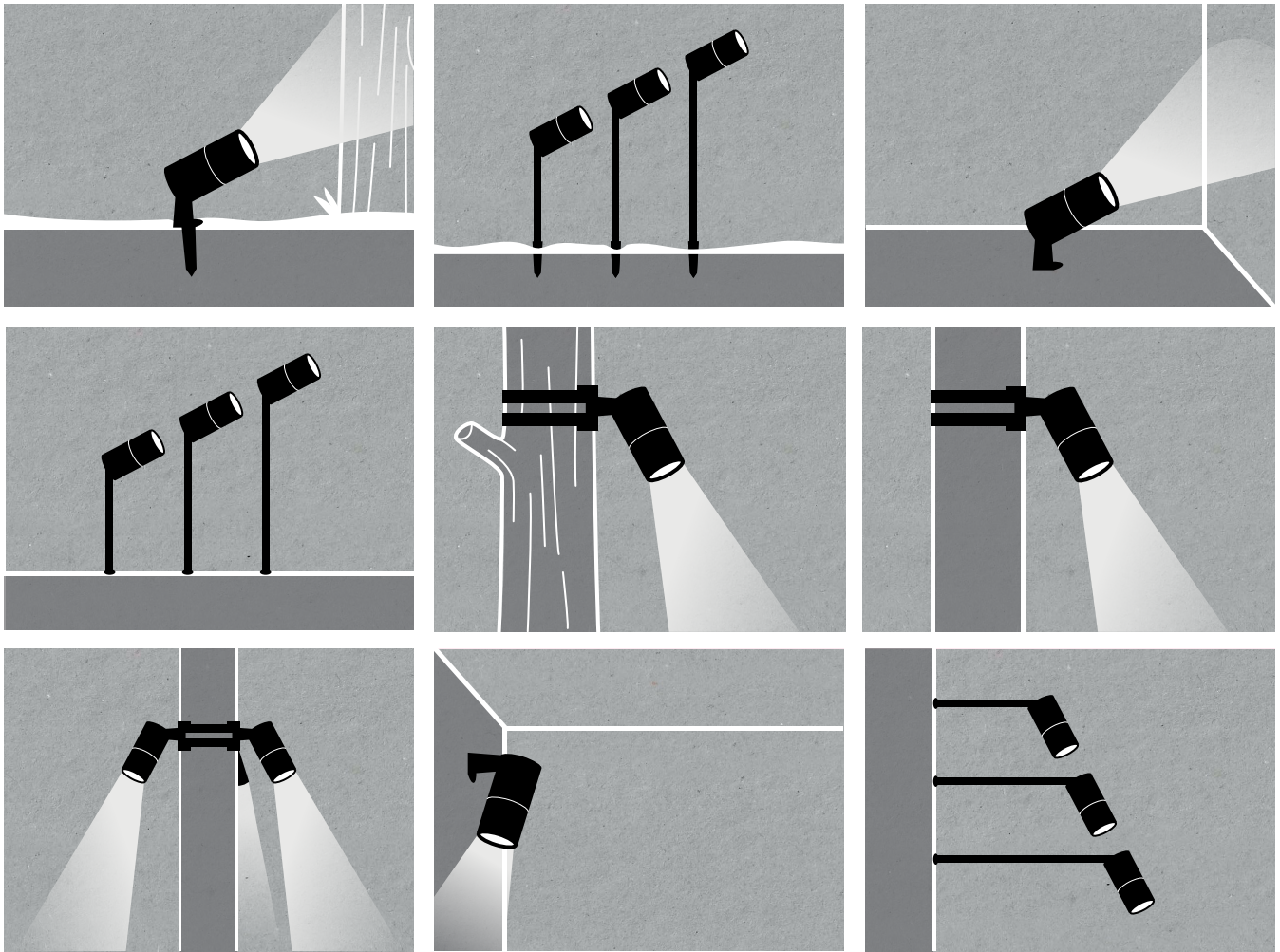

# Micro

BODY MAT AL	DIF MAT GLA		50000h L80 B20	2 MacAdam
----------------	----------------	--	-------------------	--------------

## Micro ø57mm

IP 65	IK 04	LOW FLICKER	BREEAM	 2.5 m	<b>SEA SIDE</b> SUITABLE	 ±90°		
----------	----------	----------------	--------	-----------	-----------------------------	----------	--	--

Z5 J6

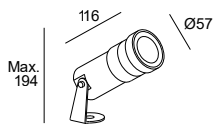

LED									
K	CRI	W Total	Real Lm	Optics	Code				
3000	80	4.7	343	17°;22°	<b>05-9881</b> - <b>Z5</b> - <b>CL</b>		ON-OFF 100-240V		
						<b>J6</b>			

## Micro ø70mm

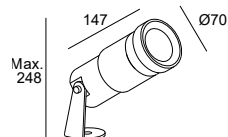

IP 66	IK 04	BREEAM	 2.5 m	<b>SEA SIDE</b> SUITABLE	 ±90°		
----------	----------	--------	-----------	-----------------------------	----------	--	--

Z5 J6



LED									
K	CRI	W Total	Real Lm	Optics	Code				
3000	80	7.5	643	16°;34°	<b>05-9988</b> - <b>Z5</b> - <b>CL</b>		ON-OFF 100-240V		
						<b>J6</b>			







	Micro ø57mm	Micro ø70mm
		

**Accesorios ópticos**  
**Accesórios óticos**

	Filtro difusor Filtro difusor	Included	Included
	Visera Viseira	Included	Included
	Set de 2 filtros (verde y amarillo) Set de 2 filtros (verde e amarelo)	Included	Included
	Set de 2 reflectores (17° y 22°) Set de 2 refletores (17° e 22°)	Included	-
	Set de 2 reflectores (16° y 34°) Set de 2 refletores (16° e 34°)	-	Included

**Accesorios de fijación**  
**Accesórios de fixação**

	Estaca Estaca	Included	Included	
	Fijación para columnas o árboles Fixação para colunas ou árvores	71-9999-Z5-Z5	71-9999-Z5-Z5	
	Anclaje (máx. 3 proyectores) Fixação (máx. 3 projetores)	71-9746-05-05	71-9746-05-05	
	Alargador pared, suelo y césped (300/500/800mm) Extensão parede, chão e relva (300/500/800mm)	Z5 ●	71-E052-Z5-Z5	71-E052-Z5-Z5
		J6 ●	71-E052-J6-J6	71-E052-J6-J6

**Accesorios de conexión**  
**Accesórios de conexão**

	Conector anticondensación IP68 (1 entrada + 1 salida) Ø 5,5 - 12mm, 4 polos Conetor anticondensação IP68 (1 entrada + 1 saída) Ø 5,5 - 12 mm, 4 polos	71-E112-00-00	71-E112-00-00
	Conector anticondensación IP68 (1 entrada + 3 salidas) Ø 5,5 - 12mm, 4 polos Conetor anticondensação IP68 (1 entrada + 3 saídas) Ø 5,5 - 12 mm, 4 polos	71-E122-00-00	71-E122-00-00
	Caja de conexión IP67 (1 entrada + 2 salidas) Ø 6 - 7,5mm, 3 polos Caixa de ligação IP67 (1 entrada + 2 saídas) Ø 6 - 7,5 mm, 3 polos	71-9262-05-05	71-9262-05-05
	Caja de conexión IP68 (1 entrada + 5 salidas) Ø 6,5 - 11mm, 6 polos Caixa de ligação IP68 (1 entrada + 5 saídas) Ø 6,5 - 11 mm, 6 polos	71-9199-05-05	71-9199-05-05

# Zoom



+ Zoom



## Adaptable al crecimiento de la vegetación Adaptável ao crescimento da vegetação

Las luminarias Zoom permiten ajustar el haz de luz rápidamente, de forma manual y sin necesidad de herramientas, lo que resulta muy útil, tanto para adaptarse al crecimiento natural de la vegetación como en aquellos proyectos en los que el efecto de luz deseado se elige durante la misma instalación.

As luminárias Zoom permitem ajustar o feixe de luz rapidamente, de forma manual e sem necessidade de ferramentas, o que é muito útil tanto para se adaptar ao crescimento natural da vegetação como para projetos onde o efeito de luz desejado é escolhido durante a própria instalação.



Kit base para aplicación semienterrada  
Kit base para aplicação semienterrado



Kit de base para aplicación de superficie  
Kit base para aplicação de superfície





Ángulo de apertura regulable gracias a un sistema zoom manual sin necesidad de herramientas

Ângulo de abertura regulável graças a um sistema de zoom manual, sem serem necessárias ferramentas

Cabezal con lupa para pasar de ángulo Spot a Medium  
Cabeça com lupa para passar de ângulo Spot a Medium



Cabezal sin lupa para pasar de ángulo Medium a Flood  
Cabeça sem lupa para passar de ângulo Medium a Flood





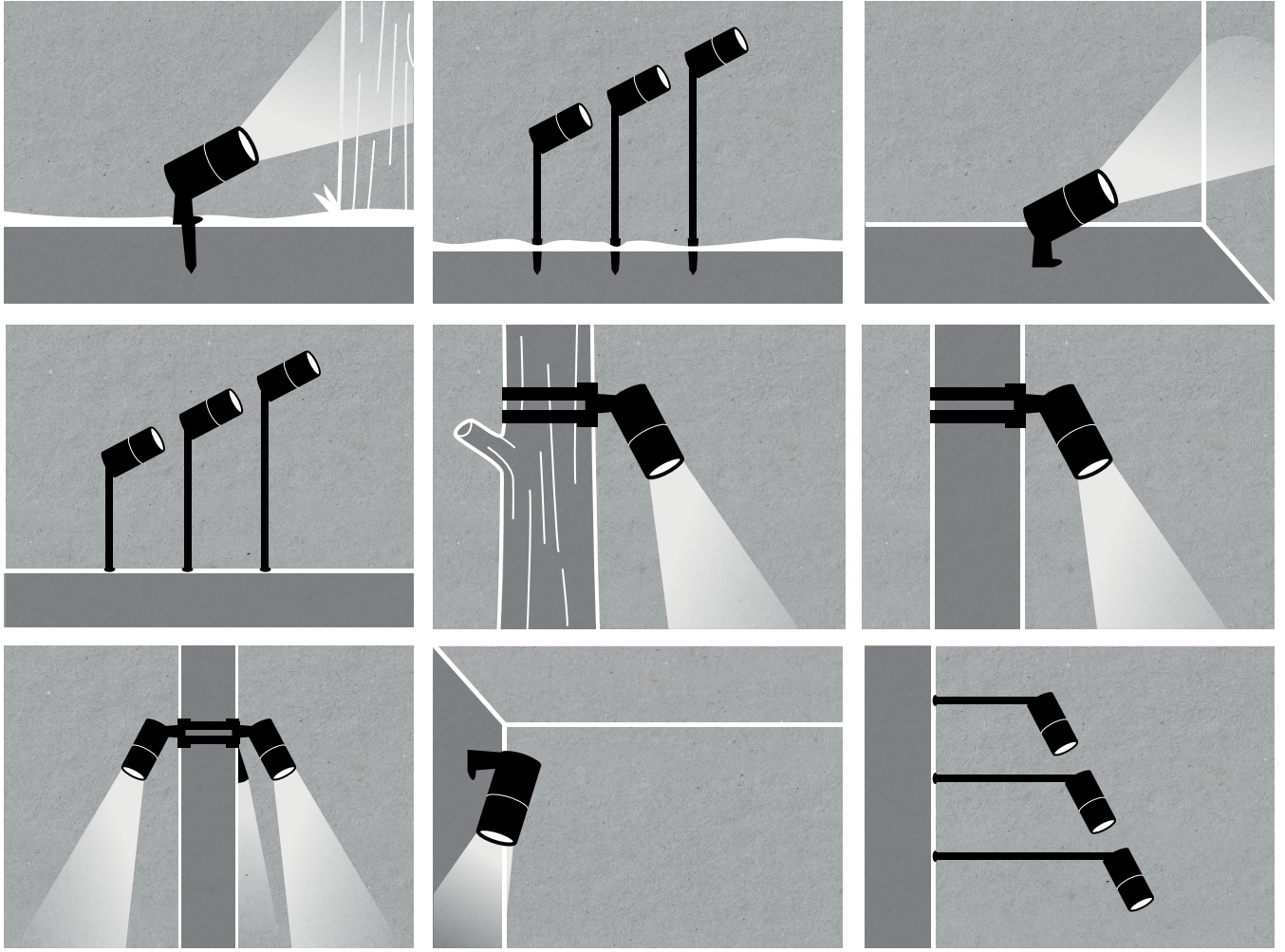

BODY MAT	DIF MAT		50000h	3
AL	PMMA		L80 B20	MacAdam

## Zoom Horizontal

IP	IK	BREEAM				
66	10		0.2 m	SEA SIDE SUITABLE	±90°	

●  
05

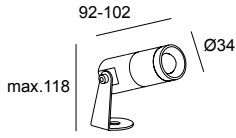

LED						max.1200mA 3V
K	CRI	W	Real Lm	Optics	Code	
2700	80	3.8	270	Zoom 7° - 105°	<b>05-E060 - 05 - CK</b>	
3000	80	3.8	270	Zoom 7° - 105°	<b>05-E060 - 05 - CL</b>	
4000	80	3.8	270	Zoom 7° - 105°	<b>05-E060 - 05 - CM</b>	

## Zoom Medium

IP	IK	BREEAM				
66	10		0.2 m	SEA SIDE SUITABLE	±90°	

●  
05

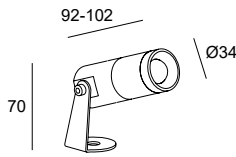

LED						max.700mA 12V
K	CRI	W	Real Lm	Optics	Code	
2700	80	8.4	428	Zoom 7° - 105°	<b>05-E061 - 05 - CK</b>	
3000	80	8.4	428	Zoom 7° - 105°	<b>05-E061 - 05 - CL</b>	
4000	80	8.4	428	Zoom 7° - 105°	<b>05-E061 - 05 - CM</b>	

### Zoom Horizontal

### Zoom Medium





## Drivers



### Driver

P. 1166

	ON-OFF IP20	<b>71-4914-00-00</b> Min.1 - Max.12	<b>71-3308-00-00</b> Min.1 - Max.1
	ON-OFF IP68	-	<b>71-E014-00-00</b> Min.1 - Max.1
	1-10V DALI2 IP68	<b>71-E518-00-00</b> Min.4 - Max.12	-
	DALI2 IP20	-	<b>71-6192-00-00</b> Min.1 - Max.2
	DALI2 IP68	-	<b>71-E080-00-00</b> Min.1 - Max.3
	Driver Not Dimmable Driver Not Dimmable	-	<b>71-4913-00-00</b> Min.1 - Max.

	<b>Zoom Horizontal</b>	<b>Zoom Medium</b>
		

**Drivers** P. 1166  
**Driver**

	Base con driver ON-OFF Base com driver ON-OFF	<b>71-E364-05-05</b>	<b>71-E039-05-05</b>
	Base con driver DALI Base com driver DALI	-	<b>71-E041-05-05</b>
	Estaca con driver ON-OFF Estaca com driver ON-OFF	<b>71-E225-05-05</b>	<b>71-E226-05-05</b>





**Controladores** P. 1166  
**Controladores**

	DALI IP67	<b>71-A237-00-00</b>  Min.BROADCAST - Max. BROADCAST	<b>71-A237-00-00</b>  Min.BROADCAST - Max. BROADCAST
-----------------------------------------------------------------------------------	--------------	-----------------------------------------------------------------------------------------------------------------------------------------------	-----------------------------------------------------------------------------------------------------------------------------------------------

**Accesorios ópticos**  
**Acessórios óticos**

	Visera Viseira	Included	Included
-------------------------------------------------------------------------------------	-------------------	----------	----------

**Accesorios de fijación**  
**Acessórios de fixação**

	Estaca de 235mm Estaca de 235 mm	<b>71-9997-05-05</b>	<b>71-9997-05-05</b>
	Estaca de 302mm Estaca de 302 mm	<b>71-9998-05-05</b>	<b>71-9998-05-05</b>
	Fijación para columnas o árboles Fixação para colunas ou árvores	<b>71-9999-Z5-Z5</b>	<b>71-9999-Z5-Z5</b>
	Anclaje (máx. 3 proyectores) Fixação (máx. 3 projetores)	<b>71-9746-05-05</b>	<b>71-9746-05-05</b>
	Alargador pared, suelo y césped (300/500/800mm) Extensão parede, chão e relva (300/500/800mm)	<b>71-E052-Z5-Z5</b>	<b>71-E052-Z5-Z5</b>

**Accesorios de conexión**  
**Acessórios de conexão**

	Conector anticondensación IP68 (1 entrada + 1 salida) Ø 5,5 - 12mm, 4 polos Conetor anticondensação IP68 (1 entrada + 1 saída) Ø 5,5 - 12 mm, 4 polos	<b>71-E112-00-00</b>	<b>71-E112-00-00</b>
-------------------------------------------------------------------------------------	----------------------------------------------------------------------------------------------------------------------------------------------------------	----------------------	----------------------



# SUV



BODY MAT	DIF MAT		50000h	2
AL	GLA		L80 B20	MacAdam

## Iluminación de acento leal Iluminação com realce leal

Suv ha sido concebida para aquellos espacios que precisan luces de acento leales y funcionales.

Driver incluido dentro de la luminaria.

Suv foi concebida para aqueles espaços que requerem uma iluminação de realce leal e funcional.

Driver incluído dentro da luminária.



### Suv 61mm

IP	IK	BREEAM		SEA SIDE SUITABLE			
65	06		1 m		±90°		

Z5

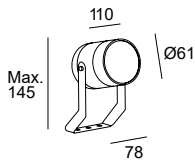

LED							
K	CRI	W Total	Real Lm	Optics	Code		
3000	80	5.5	434	22°	<b>05-E046 - Z5 - CL</b>	ON-OFF 100-240V	

### Suv 80mm

IP	IK				
65	06	1 m	±90°		

Z5

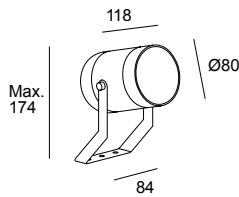

LED							
K	CRI	W Total	Real Lm	Optics	Code		
3000	80	13.5	1294	29°	<b>05-E057 - Z5 - CL</b>	ON-OFF 100-240V	

	Suv 61mm	Suv 80mm
		

**Accesorios de fijación**  
**Acessórios de fixação**

	Estaca Estaca	Included	Included
-----------------------------------------------------------------------------------	------------------	----------	----------

**Accesorios de conexión**  
**Acessórios de conexão**

	Conector anticondensación IP68 (1 entrada + 1 salida) Ø 5,5 - 12mm, 4 polos Conetor anticondensação IP68 (1 entrada + 1 saída) Ø 5,5 - 12 mm, 4 polos	<b>71-E112-00-00</b>	<b>71-E112-00-00</b>
	Conector anticondensación IP68 (1 entrada + 3 salidas) Ø 5,5 - 12mm, 4 polos Conetor anticondensação IP68 (1 entrada + 3 saídas) Ø 5,5 - 12 mm, 4 polos	<b>71-E122-00-00</b>	<b>71-E122-00-00</b>
	Caja de conexión IP67 (1 entrada + 2 salidas) Ø 6 - 7,5mm, 3 polos Caixa de ligação IP67 (1 entrada + 2 saídas) Ø 6 - 7,5 mm, 3 polos	<b>71-9262-05-05</b>	<b>71-9262-05-05</b>
	Caja de conexión IP68 (1 entrada + 5 salidas) Ø 6,5 - 11mm, 6 polos Caixa de ligação IP68 (1 entrada + 5 saídas) Ø 6,5 - 11 mm, 6 polos	<b>71-9199-05-05</b>	<b>71-9199-05-05</b>

# Helio



## Helio AISI 316

BODY MAT	DIF MAT
AL	GLA



### Fiabilidad con bombillas tradicionales Fiabilidade com lâmpadas tradicionais

Helio es una colección de luminarias para espacios en los que no se requiere una iluminación constante ni un un flujo lumínico muy alto. Mediante las tradicionales bombillas, esta solución ofrece una iluminación fiable y de calidad.

Helio é uma coleção de luminárias para espaços onde não é necessária uma iluminação constante nem um alto fluxo lumínico. Utilizando as lâmpadas tradicionais, esta solução oferece uma iluminação fiável e de qualidade.



IP	IK	SEA SIDE SUITABLE	↔	↻
66	10		360°	±45°

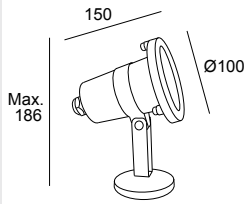

GU10	<b>Code</b>
<b>W</b>	<b>05-9310 - CA - 37</b>
Max. 8	

### Accesorios de fijación Acessórios de fixação



Estaca  
Estaca

Included

# Helio

## Aluminium

BODY MAT	DIF MAT	
AL	GLA	

### Helio GU10

IP	IK	SEA SIDE	
65	10	SUITABLE	

05 34

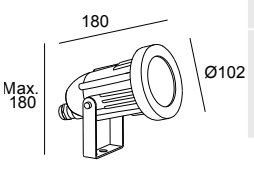

GU10	<b>Code</b>
<b>W</b>	<b>05-9640 - 05 - 34 - 37</b>
Max. 8	

### Helio E27

IP	IK		SEA SIDE	
65	06	2.5 m	SUITABLE	

Z5

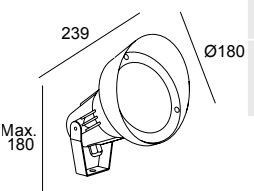

E27	<b>Code</b>
<b>W</b>	<b>05-9789 - Z5 - 37</b>
Max. 15	

### Accesorios de fijación

#### Accessórios de fixação

	Estaca Estaca	Included
	Fijación para columnas o árboles Fixação para colunas ou árvores	71-9999-Z5-Z5
	Anclaje (máx. 3 proyectores) Fixação (máx. 3 projetores)	71-9746-05-05
	Alargador pared, suelo y césped (300/500/800mm) Extensão parede, chão e relva (300/500/800mm)	71-E052-Z5-Z5
	Base para cables de Ø6mm - Ø13,5mm Base para cabos de Ø6mm - Ø13,5mm	71-E016-Z5-Z5

# Sumergibles Submersíveis

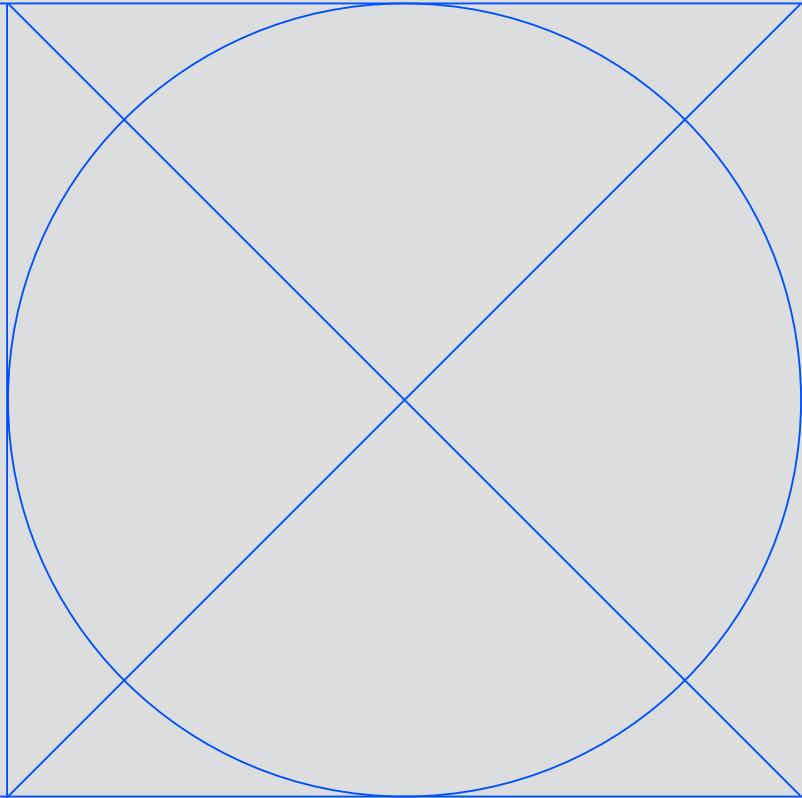

Aqua

670

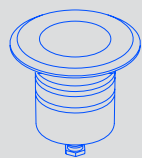

## Aqua Spotlight AISI 316

BODY MAT	DIF MAT
PC,AL	GLA



### Solución sumergible Solução submersível

En proyectos en los que se requiere un sumergible de calidad, realizado con acero inoxidable del tipo AISI316, Aqua es la solución ideal, ya que aporta un plus de resistencia en ambientes con atmósfera marina.

Em projetos onde é necessário um submersível de qualidade, realizado em aço inoxidável do tipo AISI316, Aqua é a solução ideal, já que proporciona um plus de resistência em ambientes com atmosfera marinha.



### Aqua Spotlight AISI 316 LED

IP	IK	50000h	BREEAM	3		SEA SIDE SUITABLE			
68	10	L80 B20		MacAdam	2.5 m		360°	±45°	

CA

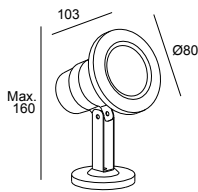

LED						12V AC/DC
K	CRI	W	Real Lm	Optics	Code	
4000	90	5	311	24°	05-9889 - CA - CM	

P. XXX

### Aqua Spotlight AISI 316 GU5.3

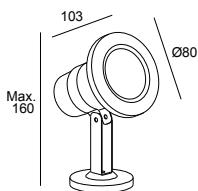
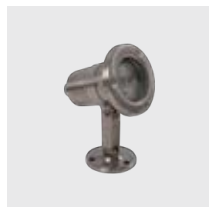

IP	IK	BREEAM		SEA SIDE SUITABLE		
68	10		2.5 m		360°	±45°

CA



GU5.3		
W	Code	
Max. 5	05-9245 - CA - 37	



	Aqua Spotlight AISI 316 LED	Aqua Spotlight AISI 316 GU5.3
		

**Accesorios de fijación**  
**Acessórios de fixação**

	Estaca Estaca	Included	Included
-----------------------------------------------------------------------------------	------------------	----------	----------

**Accesorios de conexión**  
**Acessórios de conexão**

	Conector anticondensación IP68 (1 entrada + 1 salida) Ø 5,5 - 12mm, 4 polos Conetor anticondensação IP68 (1 entrada + 1 saída) Ø 5,5 - 12 mm, 4 polos	<b>71-E112-00-00</b>	<b>71-E112-00-00</b>
	Conector anticondensación IP68 (1 entrada + 3 salidas) Ø 5,5 - 12mm, 4 polos Conetor anticondensação IP68 (1 entrada + 3 saídas) Ø 5,5 - 12 mm, 4 polos	<b>71-E122-00-00</b>	<b>71-E122-00-00</b>
	Caja de conexión IP68 (1 entrada + 5 salidas) Ø 6,5 - 11mm, 6 polos Caixa de ligação IP68 (1 entrada + 5 saídas) Ø 6,5 - 11 mm, 6 polos	<b>71-9199-05-05</b>	<b>71-9199-05-05</b>

# Aqua

## Recessed AISI 316

BODY MAT
PC,AL

DIF MAT
GLA



### Solución sumergible

### Solução submersível

En proyectos en los que se requiere un sumergible de calidad, realizado con acero inoxidable del tipo AISI316, Aqua es la solución ideal, ya que aporta un plus de resistencia en ambientes con atmósfera marina.

Em projetos onde é necessário um submersível de qualidade, realizado em aço inoxidável do tipo AISI316, Aqua é a solução ideal, já que proporciona um plus de resistência em ambientes com atmosfera marinha.



### Aqua Recessed AISI 316 LED

IP 68	IK 08	50000h L80 B20	BREEAM	3 MacAdam	1000 Kg	5 m	SEA SIDE SUITABLE	LED
----------	----------	-------------------	--------	--------------	---------	-----	----------------------	-----

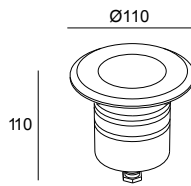
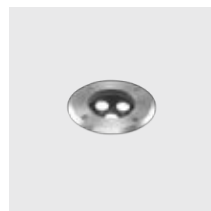

LED						12V AC/DC
<b>K</b>	<b>CRI</b>	<b>W</b>	<b>Real Lm</b>	<b>Optics</b>	<b>Code</b>	
4000	80	5	313	24°	<b>55-9792 - CA - CM</b>	

P. XXX

### Aqua Recessed AISI 316 GU5.3

IP 68	IK 08	BREEAM	1000 Kg	2.5 m	SEA SIDE SUITABLE
----------	----------	--------	---------	-------	----------------------

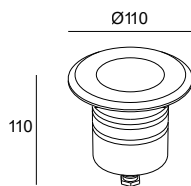

GU5.3					
<b>W</b>					<b>Code</b>
Max. 5					<b>55-9245 - CA - 37</b>

### Accesorios de fijación

### Acessórios de fixação



Caja de empotrar  
Caixa de encastrar

Included

### Accesorios de conexión

### Acessórios de conexão



Conector anticondensación IP68 (1 entrada + 1 salida) Ø 5,5 - 12mm, 4 polos  
Conetor anticondensação IP68 (1 entrada + 1 saída) Ø 5,5 - 12 mm, 4 polos

**71-E112-00-00**



Conector anticondensación IP68 (1 entrada + 3 salidas) Ø 5,5 - 12mm, 4 polos  
Conetor anticondensação IP68 (1 entrada + 3 saídas) Ø 5,5 - 12 mm, 4 polos

**71-E122-00-00**



Caja de conexión IP68 (1 entrada + 5 salidas) Ø 6,5 - 11mm, 6 polos  
Caixa de ligação IP68 (1 entrada + 5 saídas) Ø 6,5 - 11 mm, 6 polos

**71-9199-05-05**

## Solución sumergible Solução submersível

En proyectos en los que se requiere un sumergible de calidad, realizado con acero inoxidable del tipo AISI316, Aqua es la solución ideal, ya que aporta un plus de resistencia en ambientes con atmósfera marina.

Em projetos onde é necessário um submersível de qualidade, realizado em aço inoxidável do tipo AISI316, Aqua é a solução ideal, já que proporciona um plus de resistência em ambientes com atmosfera marinha.

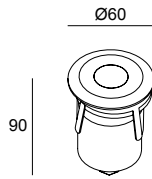
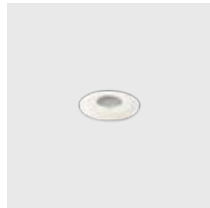

50 0-20 mm

LED						max.700mA 3V
K	CRI	W	Real Lm	Optics	Code	
4000	80	2.2	52	96°	55-9622 - 14 - CM	

### Drivers Driver

P. 1166



ON-OFF  
IP20

**71-3308-00-00**  
Min.1 - Max.7



ON-OFF  
IP68

**71-E014-00-00**  
Min.1 - Max.4



DALI2  
IP20

**71-6192-00-00**  
Min.1 - Max.8



DALI2  
IP68

**71-E080-00-00**  
Min.1 - Max.13

### Controladores Controladores

P. 1166



CASAMBI\*  
IP67

**71-A237-00-00**  
BROADCAST

\*DALI driver required.

### Accesorios ópticos Acessórios óticos



Filtros de color  
Filtros de cor

Included

### Accesorios de fijación Acessórios de fixação



Caja de empotrar  
Caixa de encastrar

Included



Base para empotrar  
Base para encastrar

Included

### Accesorios de conexión Acessórios de conexão



Conector anticondensación IP68 (1 entrada + 1 salida) Ø 5,5 - 12mm, 4 polos  
Conetor anticondensação IP68 (1 entrada + 1 saída) Ø 5,5 - 12 mm, 4 polos

**71-E112-00-00**



Conector anticondensación IP68 (1 entrada + 3 salidas) Ø 5,5 - 12mm, 4 polos  
Conetor anticondensação IP68 (1 entrada + 3 saídas) Ø 5,5 - 12 mm, 4 polos

**71-E122-00-00**



Caja de conexión IP68 (1 entrada + 5 salidas) Ø 6,5 - 11mm, 6 polos  
Caixa de ligação IP68 (1 entrada + 5 saídas) Ø 6,5 - 11 mm, 6 polos

**71-9199-05-05**

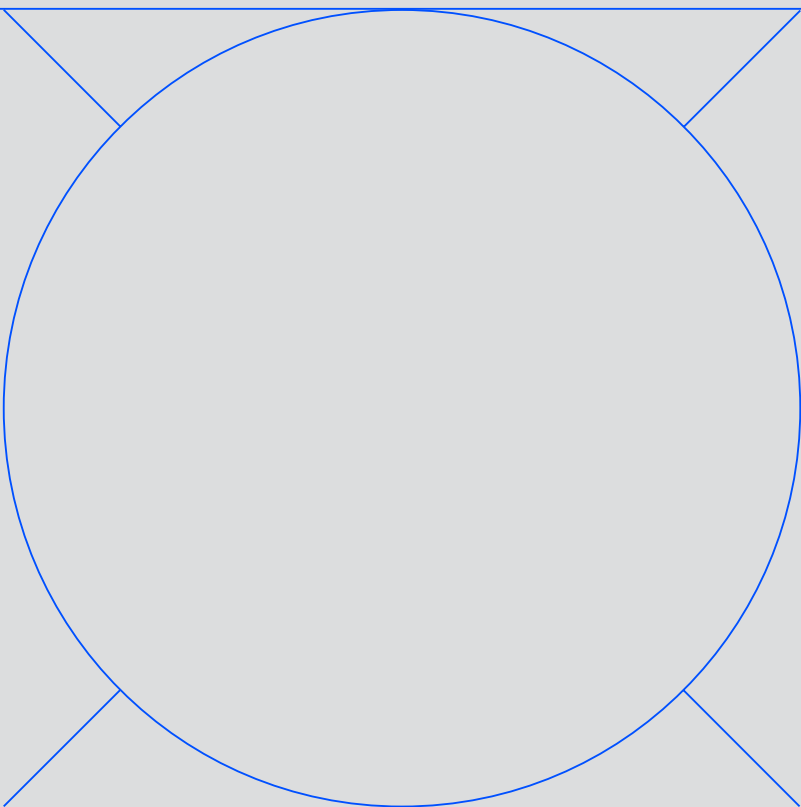

# Empotrables de suelo

## Encastráveis no solo

Max

676



Gea

686

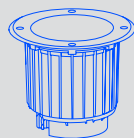

Kay

714

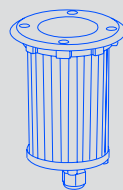

Ios

718



Rim

724

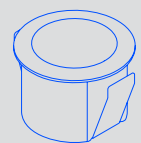

Pixel

728



Xena

732

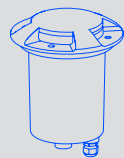

# Max

Designed by LedsC4 Architectural



+ Max

## Excelente control de luz Excelente controlo da luz

El objetivo de los empotrables de suelo Max es ofrecer el máximo control. Para conseguirlo utiliza una extensa gama de opciones: ópticas, potencias, regulaciones, temperaturas de color, acabados y accesorios ópticos. Combinando estas opciones se consigue un control total de la luz para adaptarla a todas las situaciones y necesidades.

Os objetivo dos encastrados de chão Max é oferecer o máximo controlo. Para o conseguir, utiliza uma extensa gama de opções: óticas, potências, regulações, temperaturas de cor, acabamentos e acessórios óticos. Ao combinar estas opções, consegue-se um controlo total da luz para a adaptar a todas as situações e necessidades.



### Nuevos acabados metálicos Novos acabamentos metálicos

Acero inoxidable  
Aço inoxidável

Latón dorado  
Latão dourado

Cromo bruñido  
Cromado polido







Small  
Ø35mm



Medium  
Ø50mm



Big  
Ø75mm



Tamaño compacto  
Tamanho compacto

2 posibilidades de  
alimentación remota.  
2 possibilidades de  
alimentação remota.















350mA  
500mA  
700mA

24V

## Max Mini Uplight













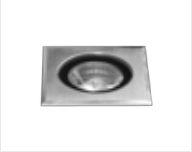





Ejemplo de código / Exemplo de código: **BA11-P2V8S1BBCA**

Model	W	K / Cri / Real lm	Optics	Source	Finishes
 <p><b>BA11 -</b> Cuadrado / Con marco Cuadrado / Com aro ⌀ 33</p>  	Constant Current 700mA				
	<b>P2</b> 2.2W	<b>V8</b> 2700K / CRI 80 / 163 lm	<b>S1</b> 10°	<b>BB</b>  3V/max.700mA	<b>CA</b>  <b>I7</b>  <b>I8</b>  <b>Z5</b> 
		<b>W8</b> 3000K / CRI 80 / 185 lm	<b>S2</b> 15°		
<b>X8</b> 4000K / CRI 80 / 191 lm	<b>M3</b> 32°	<b>F2</b> 53°			
 <p><b>BA12 -</b> Redondo / Con marco Redondo / Com aro ⌀ 33</p>  	Constant Voltage 24V				
	<b>P3</b> 2.5W	<b>V8</b> 2700K / CRI 80 / 94 lm	<b>S3</b> 19°	<b>BB</b>  24VDC	
		<b>W8</b> 3000K / CRI 80 / 97 lm	<b>M3</b> 32°		
<b>X8</b> 4000K / CRI 80 / 87 lm	<b>F2</b> 51°				
 <p><b>BA13 -</b> Redondo / Sin marco Redondo / Sem aro</p>  					

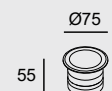



# Max Medium Uplight





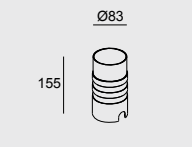

Ejemplo de código / Exemplo de código: **AI11-P4V9S1BBCA**

Model	W	K / Cri / Real lm	Optics	Source	Finishes	
 <p><b>AI11 -</b> Cuadrado / Con Marco Quadrado / Com aro Ⓜ 60</p>  	Constant Current 350mA					
	<b>P4</b> 4W	<b>V9</b>	2700K / CRI 90 / 286 lm	<b>S1</b> 9°	<b>BB</b>  12V/max.350mA	<b>CA</b>  <b>I7</b>  <b>I8</b>  <b>Z5</b> 
		<b>W9</b>	3000K / CRI 90 / 286 lm			
		<b>X9</b>	4000K / CRI 90 / 286 lm			
	<b>P7</b> 6.5W	<b>V9</b>	2700K / CRI 90 / 519 lm	<b>S2</b> 17°	<b>BB</b>  18V/max.350mA	
		<b>W9</b>	3000K / CRI 90 / 459 lm			
<b>X9</b>		4000K / CRI 90 / 423 lm				
 <p><b>AI12 -</b> Redondo / Con marco Redondo / Com aro Ⓜ 60</p>  	Constant Voltage 24V					
	<b>P6</b> 6W	<b>V9</b>	2700K / CRI 90 / 204 lm	<b>S1</b> 9°	<b>BB</b>  24VDC	
		<b>W9</b>	3000K / CRI 90 / 204 lm			
		<b>X9</b>	4000K / CRI 90 / 204 lm			
	<b>P8</b> 7.9W	<b>V9</b>	2700K / CRI 90 / 519 lm	<b>S2</b> 17°	<b>BB</b>  24VDC	
		<b>W9</b>	3000K / CRI 90 / 459 lm			
<b>X9</b>		4000K / CRI 90 / 423 lm				
 <p><b>AI13 -</b> Redondo / Sin marco Redondo / Sem aro</p>  						
				<b>F1</b> 50°		

Ejemplo de código / Exemplo de código: **AT11-18V9S3BBCA**

Model	W	K / Cri / Real lm	Optics	Source	Finishes
 <p><b>AT11 -</b> Cuadrado / Com aro 85</p> <p>CA I7 I8</p> 	Constant Current 500mA				
	<b>18</b> 17.3W	<b>V9</b> 2700K / CRI 90 / 1844 lm <b>W9</b> 3000K / CRI 90 / 2047 lm <b>X9</b> 4000K / CRI 90 / 1803 lm	<b>S3</b> 21° <b>M3</b> 31° <b>F1</b> 40°	<b>BB</b> 36V/max.500mA	<b>CA</b> <b>I7</b> <b>I8</b>
Constant Voltage 24V					
 <p><b>AT12 -</b> Redondo / Con marco 85</p> <p>CA I7 I8</p> 	<b>14</b> 13.8W	<b>V9</b> 2700K / CRI 90 / 1086 lm <b>W9</b> 3000K / CRI 90 / 1076 lm <b>X9</b> 4000K / CRI 90 / 1120 lm	<b>S3</b> 16° <b>M2</b> 28° <b>F2</b> 51°	<b>BB</b> 24VDC	
	 <p><b>AT13 -</b> Redondo / Sin marco 85</p> <p>CA</p> 				

	Max Mini Uplight Constant Current	Max Mini Uplight Constant Voltage	Max Medium Uplight Constant Current P4	Max Medium Uplight Constant Current
				



## Drivers Driver

P. 1166

	ON-OFF IP20	<b>71-3308-00-00</b> Min.1 - Max.7	-	<b>71-7701-00-00</b>  Min.1 - Max.1	<b>71-7701-00-00</b>  Min.1 - Max.2
	ON-OFF IP68	<b>71-E014-00-00</b> Min.1 - Max.4	-	<b>71-E079-00-00</b>  Min.1 - Max.4	<b>71-E079-00-00</b>  Min.1 - Max.2
	1-10V DALI2 IP68	-	-	<b>71-E083-00-00</b> Min.1 - Max.4	<b>71-E083-00-00</b> Min.1 - Max.2
	1-10V DALI2 PUSH IP20	-	-	<b>71-4706-00-00</b> Min.1 - Max.6	<b>71-4706-00-00</b> Min.1 - Max.4
	DALI2 IP20	<b>71-6192-00-00</b> Min.1 - Max.8	-	-	-
	DALI2 IP68	<b>71-E080-00-00</b> Min.1 - Max.14	-	-	-
	CASAMBI IP20	<b>71-A260-00-00</b> Min.4 - Max.15	-	<b>71-A260-00-00</b>  Min.1 - Max.4	<b>71-A260-00-00</b>  Min.1 - Max.2
	Not Dimmable IP20	<b>71-A654-00-00</b>  Min.1 - Max.1	-	-	-

## Fuentes de alimentación Fontes de alimentação

P. 1166

	ON-OFF IP67	-	<b>71-E158-00-00</b> Min.1 - Max.9	-	-
	DALI2 IP67	-	<b>71-E098-00-00</b> Min.1 - Max.20	-	-
	Fuente de alimentación estanca con conectores IP67 Fonte de alimentação estanque com conectores IP67	-	<b>71-E101-05-05</b> Min.1 - Max.7	-	-

## Controladores Controladores

P. 1166

	CASAMBI IP67	-	<b>71-A242-00-00</b> Min.1 - Max.20	-	-
-------------------------------------------------------------------------------------	-----------------	---	----------------------------------------	---	---

Max Medium  
Uplight Constant  
Voltage P6



Max Medium  
Uplight Constant  
Voltage



Max Big Uplight  
Constant Current



Max Big Uplight  
Constant Voltage













**Drivers**  
Driver

P. 1166

	ON-OFF IP20	-	-	<b>71-3542-00-00</b>  Min.1 - Max.2	-
	ON-OFF IP68	-	-	<b>71-E079-00-00</b>  Min.1 - Max.1	-
	1-10V DALI2 IP68	-	-	<b>71-E083-00-00</b>  Min.1 - Max.1	-
	1-10V DALI2 PUSH IP20	-	-	<b>71-4706-00-00</b>  Min.1 - Max.2	-
	DALI2 IP20	-	-	-	-
	DALI2 IP68	-	-	-	-
	CASAMBI IP20	-	-	<b>71-A260-00-00</b>  Min.1 - Max.1	-
	Not Dimmable IP20	-	-	-	-



**Fuentes de alimentación**  
Fontes de alimentação





P. 1166

	ON-OFF IP67	<b>71-E159-00-00</b>  Min.1 - Max.9	<b>71-E159-00-00</b>  Min.1 - Max.7	-	<b>71-6341-00-00</b>  Min.1 - Max.7
	DALI2 IP67	<b>71-E098-00-00</b>  Min.1 - Max.9	<b>71-E098-00-00</b>  Min.1 - Max.7	-	<b>71-E099-00-00</b>  Min.1 - Max.8
	Fuente de alimentación estanca con conectores IP67 Fonte de alimentação estanque com conectores IP67	<b>71-E101-05-05</b>  Min.1 - Max.3	<b>71-E101-05-05</b>  Min.1 - Max.2	-	<b>71-E101-05-05</b>  Min.1 - Max.1

**Controladores**  
Controladores

P. 1166

	CASAMBI IP67	<b>71-A242-00-00</b> Min.4 - Max.15	<b>71-A242-00-00</b> Min.4 - Max.12	-	<b>71-A242-00-00</b>  Min.1 - Max.8
-------------------------------------------------------------------------------------	-----------------	----------------------------------------	----------------------------------------	---	-----------------------------------------------------------------------------------------------------------------------------

	Max Mini Uplight Constant Current	Max Mini Uplight Constant Voltage	Max Medium Uplight Constant Current P4	Max Medium Uplight Constant Current
				

### Accesorios ópticos

#### Acessórios óticos

	Panel de abeja (5u.) Painel de abelha (5u.)	<b>71-E422-00-00</b>	<b>71-E422-00-00</b>	<b>71-E131-00-00</b>	<b>71-E131-00-00</b>
	Difusor cuadrado (5u.) Difusor quadrado (5u.)	<b>71-E421-00-00</b>	<b>71-E421-00-00</b>	<b>71-E135-00-00</b>	<b>71-E135-00-00</b>
	Difusor elíptico (5u.) Difusor elíptico (5u.)	<b>71-E420-00-00</b>	<b>71-E420-00-00</b>	<b>71-E141-00-00</b>	<b>71-E141-00-00</b>
	Difusor opal (5u.) Difusor opal (5u.)	<b>71-E419-00-00</b>	<b>71-E419-00-00</b>	<b>71-E133-00-00</b>	<b>71-E133-00-00</b>
	Difusor wall washer (5u.) Wall washer diffuser (5u.)	<b>71-E462-00-00</b>	<b>71-E462-00-00</b>	<b>71-E463-00-00</b>	<b>71-E463-00-00</b>

### Accesorios de fijación

#### Acessórios de fixação

	Caja de empotrar Caixa de encastrar	-	-	Included	Included
-------------------------------------------------------------------------------------	----------------------------------------	---	---	----------	----------

### Accesorios de conexión

#### Acessórios de conexão

	Conector IP67 (1 entrada + 1 salida) Ø 5,5 - 7,5mm, 3 polos Conetor IP67 (1 entrada + 1 saída) Ø 5,5 - 7,5 mm, 3 polos	<b>71-E510-00-00</b>	<b>71-E510-00-00</b>	<b>71-E510-00-00</b>	<b>71-E510-00-00</b>
	Conector IP67 (1 entrada + 2 salidas) Ø 5,5 - 7,5mm, 3 polos Conetor IP67 (1 entrada + 2 saídas) Ø 5,5 - 7,5 mm, 3 polos	<b>71-E511-00-00</b>	<b>71-E511-00-00</b>	<b>71-E511-00-00</b>	<b>71-E511-00-00</b>
	Conector IP68 (1 entrada + 1 salida) Ø 5,5 - 11,5mm, 4 polos Conetor IP68 (1 entrada + 1 saída) Ø 5,5 - 11,5 mm, 4 polos	<b>71-E512-00-00</b>	<b>71-E512-00-00</b>	<b>71-E512-00-00</b>	<b>71-E512-00-00</b>
	Conector IP68 (1 entrada + 2 salidas) Ø 5,5 - 11,5mm, 3 polos Conetor IP68 (1 entrada + 2 saídas) Ø 5,5 - 11,5 mm, 3 polos	<b>71-E513-00-00</b>	<b>71-E513-00-00</b>	<b>71-E513-00-00</b>	<b>71-E513-00-00</b>
	Conector anticondensación IP68 (1 entrada + 1 salida) Ø 5,5 - 12mm, 4 polos Conetor anticondensação IP68 (1 entrada + 1 saída) Ø 5,5 - 12 mm, 4 polos	<b>71-E112-00-00</b>	<b>71-E112-00-00</b>	<b>71-E112-00-00</b>	<b>71-E112-00-00</b>
	Conector anticondensación IP68 (1 entrada + 3 salidas) Ø 5,5 - 12mm, 4 polos Conetor anticondensação IP68 (1 entrada + 3 saídas) Ø 5,5 - 12 mm, 4 polos	<b>71-E122-00-00</b>	<b>71-E122-00-00</b>	<b>71-E122-00-00</b>	<b>71-E122-00-00</b>
	Caja de conexión IP68 (1 entrada + 5 salidas) Ø 6,5 - 11mm, 6 polos Caixa de ligação IP68 (1 entrada + 5 saídas) Ø 6,5 - 11 mm, 6 polos	-	-	<b>71-9199-05-05</b>	<b>71-9199-05-05</b>



Max Medium Uplight Constant Voltage P6      Max Medium Uplight Constant Voltage      Max Big Uplight Constant Current      Max Big Uplight Constant Voltage



**Accesorios ópticos**  
**Accesórios óticos**

	Panel de abeja (5u.) Painel de abelha (5u.)	<b>71-E131-00-00</b>	<b>71-E131-00-00</b>	<b>71-E263-00-00</b>	<b>71-E263-00-00</b>
	Difusor cuadrado (5u.) Difusor quadrado (5u.)	<b>71-E135-00-00</b>	<b>71-E135-00-00</b>	<b>71-E262-00-00</b>	<b>71-E262-00-00</b>
	Difusor elíptico (5u.) Difusor elíptico (5u.)	<b>71-E141-00-00</b>	<b>71-E141-00-00</b>	<b>71-E261-00-00</b>	<b>71-E261-00-00</b>
	Difusor opal (5u.) Difusor opal (5u.)	<b>71-E133-00-00</b>	<b>71-E133-00-00</b>	<b>71-E260-00-00</b>	<b>71-E260-00-00</b>
	Difusor wall washer (5u.) Wall washer diffuser (5u.)	<b>71-E463-00-00</b>	<b>71-E463-00-00</b>	<b>71-E464-00-00</b>	<b>71-E464-00-00</b>

**Accesorios de fijación**  
**Accesórios de fixação**

	Caja de empotrar Caixa de encastrar	Included	Included	-	-
--	----------------------------------------	----------	----------	---	---

**Accesorios de conexión**  
**Accesórios de conexão**

	Conector IP67 (1 entrada + 1 salida) Ø 5,5 - 7,5mm, 3 polos Conetor IP67 (1 entrada + 1 saída) Ø 5,5 - 7,5 mm, 3 polos	<b>71-E510-00-00</b>	<b>71-E510-00-00</b>	<b>71-E510-00-00</b>	<b>71-E510-00-00</b>
	Conector IP67 (1 entrada + 2 salidas) Ø 5,5 - 7,5mm, 3 polos Conetor IP67 (1 entrada + 2 saídas) Ø 5,5 - 7,5 mm, 3 polos	<b>71-E511-00-00</b>	<b>71-E511-00-00</b>	<b>71-E511-00-00</b>	<b>71-E511-00-00</b>
	Conector IP68 (1 entrada + 1 salida) Ø 5,5 - 11,5mm, 4 polos Conetor IP68 (1 entrada + 1 saída) Ø 5,5 - 11,5 mm, 4 polos	<b>71-E512-00-00</b>	<b>71-E512-00-00</b>	<b>71-E512-00-00</b>	<b>71-E512-00-00</b>
	Conector IP68 (1 entrada + 2 salidas) Ø 5,5 - 11,5mm, 3 polos Conetor IP68 (1 entrada + 2 saídas) Ø 5,5 - 11,5 mm, 3 polos	<b>71-E513-00-00</b>	<b>71-E513-00-00</b>	<b>71-E513-00-00</b>	<b>71-E513-00-00</b>
	Conector anticondensación IP68 (1 entrada + 1 salida) Ø 5,5 - 12mm, 4 polos Conetor anticondensação IP68 (1 entrada + 1 saída) Ø 5,5 - 12 mm, 4 polos	<b>71-E112-00-00</b>	<b>71-E112-00-00</b>	<b>71-E112-00-00</b>	<b>71-E112-00-00</b>
	Conector anticondensación IP68 (1 entrada + 3 salidas) Ø 5,5 - 12mm, 4 polos Conetor anticondensação IP68 (1 entrada + 3 saídas) Ø 5,5 - 12 mm, 4 polos	<b>71-E122-00-00</b>	<b>71-E122-00-00</b>	<b>71-E122-00-00</b>	<b>71-E122-00-00</b>
	Caja de conexión IP68 (1 entrada + 5 salidas) Ø 6,5 - 11mm, 6 polos Caixa de ligação IP68 (1 entrada + 5 saídas) Ø 6,5 - 11 mm, 6 polos	<b>71-9199-05-05</b>	<b>71-9199-05-05</b>	<b>71-9199-05-05</b>	<b>71-9199-05-05</b>



Colección muy extensa que no deja de evolucionar  
Coleção muito extensa que não deixa de evoluir

Gea Pro



Gea Cob



Gea Wall Washer



Gea Compact



Gea Technopolymer



Gea Signaling





**Gea Pro**

**690**

Solución avanzada, perfecta para arquitectura y monumentos.  
 Solução avançada, perfeita para arquitetura e monumentos.

**Efficiency**

Ø 85 mm



Ø 125 mm



Ø 185 mm



Ø 220 mm



Ø 300 mm



**Comfort**



**Gea Cob**

**698**

Con múltiples accesorios, es ideal para vegetación.  
 Com múltiplos acessórios, ideal para vegetação.

Ø 125 mm



Ø 185 mm



Ø 223 mm



Ø 300 mm



4.2 W - 35.4 W



S - M - F



4.2 W - 35.4 W



S - M - F



10.5 W - 35 W



S - M - F



**S:** Spot (9-20°) **M:** Medium (21-40°) **F:** Flood (41-100°) **FA** Flood Asymmetrical

Gea Wall Washer

# 702

Solución para bañar fachadas.  
 Solução para washlight de fachadas.

Ø 185 mm



Ø 233 mm



Gea Compact

# 704

Solución para suelos con poca profundidad.  
 Solução para solos com pouca profundidade.

Ø 130 mm



Ø 180 mm



Gea Signaling

# 706

Solución para iluminación de señalización.  
 Solução para iluminação de sinalização.

Ø 45 mm



Ø 60 mm



Gea Technopolymer

# 708

Solución para instalar directamente en la tierra, sin usar hormigón.  
 Solução para instalar diretamente na terra, sem usar betão.

Ø 120 mm



Ø 130 mm



Ø 185 mm



18.5 W - 27.5 W



FA



CA

8.6 W - 22 W



S - M



CA

0.5 W - 2.2 W



54

7.7 W - Max. 50 W



S - M - F



CA

# Gea Pro

**Efficiency**



**Comfort**



Solución avanzada, perfecta para  
arquitectura y monumentos.

Solução avançada, perfeita para  
arquitetura e monumentos.







Perfecta para especificar  
ângulos concretos  
Perfeita para especificar  
ângulos concretos

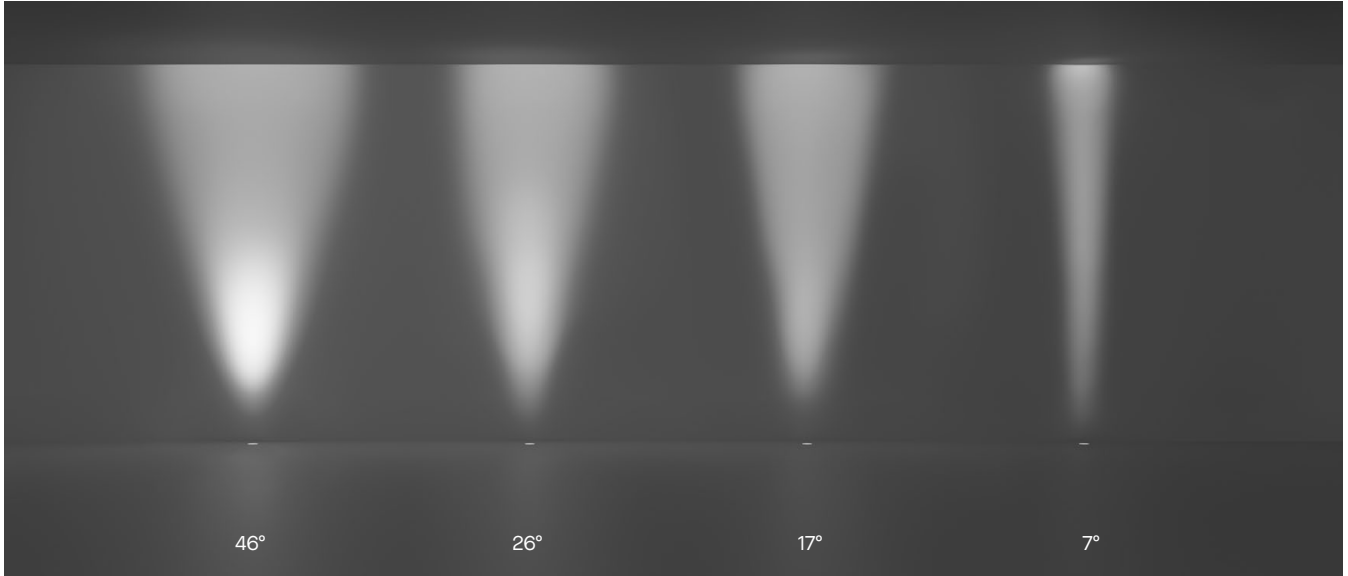

Gea Comfort  
185 mm



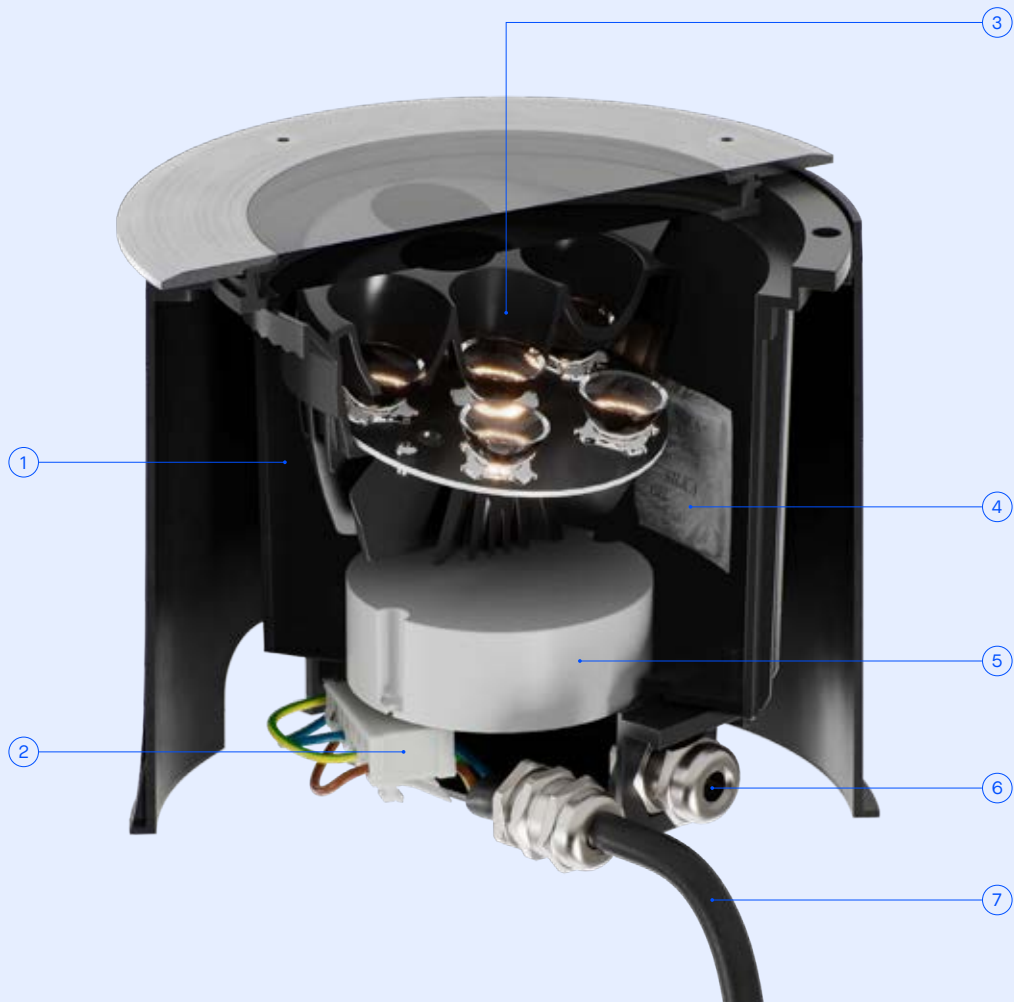

- ① **Cuerpo con tratamiento anticorrosión**  
Cuerpo con tratamiento anticorrosión
- ② **Regleta de conexión fácil sin herramientas**  
Regleta de conexión fácil sin herramientas
- ③ **Antideslumbrante**  
Antideslumbrante
- ④ **Absorbente de humedad**  
Absorbente de humedad

- ⑤ **Driver incluido**  
Driver incluido
- ⑥ **Doble prensaestopas**  
Doble prensaestopas
- ⑦ **Cable incluido**  
Cable incluido

# Gea

## Power LED Pro

IK 10		50000h L80 B20	3 MacAdam	BODY MAT AISI316,POLI	DIF MAT GLA
----------	--	-------------------	--------------	--------------------------	----------------

### Gea Pro 85mm

	IP 65	 2.5 m			 360°	 ±15°			
--	----------	-----------	--	--	----------	----------	--	--	--

Ejemplo de código / Ejemplo de código: **AZ11-P4V8S3OUCA**

Model	W	K / Cri / Real lm	Optics	Source	Finishes
  Ø85 94	<b>P4</b> 4.2W	<b>V8</b> 2700K / CRI 80 / 194 lm	<b>S3</b> 10°	<b>OU</b> ON-OFF 100-240V	<b>CA</b>
		<b>W8</b> 3000K / CRI 80 / 177 lm	<b>M2</b> 26°		
		<b>X8</b> 4000K / CRI 80 / 182 lm	<b>F1</b> 73°		

### Gea Pro 125mm

	IP 66	 1 m			 ±15°	 360°			
--	----------	---------	--	--	----------	----------	--	--	--

Ejemplo de código / Ejemplo de código: **AZ13-P2V8S1OUCA**



Model	W	K / Cri / Real lm	Optics	Source	Finishes	
  Ø125 133	<b>P2</b> 2.5W	<b>V8</b> 2700K / CRI 80 / 203 lm	<b>S1</b> 10°   7°	<b>OU</b> ON-OFF 100-240V	<b>CA</b>	
		<b>W8</b> 3000K / CRI 80 / 203 lm				
		<b>X8</b> 4000K / CRI 80 / 116 lm				
  Ø125 133	<b>P6</b> 6W	<b>V8</b> 2700K / CRI 80 / 333 lm	<b>S3</b> 11°   12°	<b>OU</b> ON-OFF 100-240V		
		<b>W8</b> 3000K / CRI 80 / 330 lm	<b>M2</b> 25°   21°			<b>DU</b> DALI-2 120-277V
		<b>X8</b> 4000K / CRI 80 / 240 lm	<b>F1</b> 40°   34°			

# Gea Pro 185mm

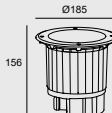

OUTDOOR

Ejemplo de código / Exemplo de código: **AZ15-P6V8S1OUC**

Model	W	K / Cri / Real lm	Optics	Source	Finishes
 	<b>P6</b> 7W	<b>V8</b> 2700K / CRI 80 / 670 lm	<b>S1</b> 10°   7°	<b>OU</b> ON-OFF 100-240V	<b>CA</b> 
		<b>W8</b> 3000K / CRI 80 / 670 lm		<b>DU</b> DALI-2 120-277V	
		<b>X8</b> 4000K / CRI 80 / 383 lm			
	<b>13</b> 14.2W	<b>V8</b> 2700K / CRI 80 / 699 lm	<b>S3</b> 17°   15°	<b>OU</b> ON-OFF 100-240V	
		<b>W8</b> 3000K / CRI 80 / 806 lm	<b>M2</b> 26°   23°	<b>DU</b> DALI-2 120-277V	
		<b>X8</b> 4000K / CRI 80 / 586 lm	<b>F1</b> 46°   37°		

# Gea Pro 220mm



Ejemplo de código / Exemplo de código: **AZ17-P8V8S1OUC**



Model	W	K / Cri / Real lm	Optics	Source	Finishes
 	<b>P8</b> 10.1W	<b>V8</b> 2700K / CRI 80 / 996 lm	<b>S1</b> 9°   9°	<b>OU</b> ON-OFF 100-240V	<b>CA</b> 
		<b>W8</b> 3000K / CRI 80 / 996 lm		<b>DU</b> DALI-2 120-277V	
		<b>X8</b> 4000K / CRI 80 / 996 lm			
	<b>17</b> 18W	<b>V8</b> 2700K / CRI 80 / 1416 lm	<b>S3</b> 11°   10°	<b>OU</b> ON-OFF 100-240V	
		<b>W8</b> 3000K / CRI 80 / 1089 lm	<b>M2</b> 26°   22°	<b>DU</b> DALI-2 120-277V	
		<b>X8</b> 4000K / CRI 80 / 791 lm	<b>F1</b> 45°   35°		
 	<b>P4</b> 5.2W	<b>N8</b> RGBW / 512 lm	<b>S1</b> 9°   9°	<b>DM</b> DMX RDM 100-240V	
	<b>P9</b> 9.8W	<b>N8</b> RGBW / 973 lm	<b>S3</b> 11°   10°	<b>DM</b> DMX RDM 100-240V	
			<b>M2</b> 26°   22°		
			<b>F1</b> 45°   35°		



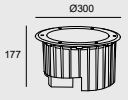

EMBOTRABLES SUELO | ENCASTRÁVEIS NO SOLO

# Gea Pro 300mm



Ejemplo de código / Exemplo de código: **AZ19-17V8S10UCA**

Model	W	K / Cri / Real lm	Optics	Source	Finishes
 	<b>17</b> 18W	<b>V8</b> 2700K / CRI 80 / 1992 lm	<b>S1</b> 9°   9°	<b>OU</b> ON-OFF 100-240V	<b>CA</b>
		<b>W8</b> 3000K / CRI 80 / 1992 lm		<b>DU</b> DALI-2/PUSH 120-277V	
		<b>X8</b> 4000K / CRI 80 / 1992 lm			
	<b>34</b> 35.4W	<b>V8</b> 2700K / CRI 80 / 2832 lm	<b>S3</b> 11°   10°	<b>OU</b> ON-OFF 100-240V	
		<b>W8</b> 3000K / CRI 80 / 2177 lm		<b>DU</b> DALI-2/PUSH 120-277V	
		<b>X8</b> 4000K / CRI 80 / 1582 lm		<b>F1</b> 45°   35°	
 	<b>P8</b> 9.8W	<b>N8</b> RGBW / 1023 lm	<b>S1</b> 9°   9°	<b>DM</b> DMX RDM 100-240V	
	<b>17</b> 18.7W	<b>N8</b> RGBW / 1946 lm	<b>S3</b> 11°   10°	<b>DM</b> DMX RDM 100-240V	
			<b>M2</b> 26°   22° <b>F1</b> 45°   35°		

Gea Power LED Pro Ø85mm Efficiency	Gea Power LED Pro Ø125mm Efficiency	Gea Power LED Pro Ø125mm Comfort	Gea Power LED Pro Ø185mm Efficiency	Gea Power LED Pro Ø185mm Comfort
				

## Accesorios de fijación Acessórios de fixação



Caja de empotrar  
Caixa de encastrar

Included Included Included Included Included

## Accesorios de conexión Acessórios de conexão



Conector IP68 (1 entrada + 1 salida) Ø 6 - 17mm, 5 polos  
Conector IP68 (1 entrada + 1 saída) Ø 6 - 17 mm, 5 polos

71-E361-00-00 71-E361-00-00 71-E361-00-00



Conector anticondensación IP68 (1 entrada + 1 salida) Ø 5,5 - 12mm, 4 polos  
Conector anticondensação IP68 (1 entrada + 1 saída) Ø 5,5 - 12 mm, 4 polos

71-E112-00-00 71-E112-00-00 71-E112-00-00 71-E112-00-00 71-E112-00-00



Conector anticondensación IP68 (1 entrada + 3 salidas) Ø 5,5 - 12mm, 4 polos  
Conector anticondensação IP68 (1 entrada + 3 saídas) Ø 5,5 - 12 mm, 4 polos

71-E122-00-00 71-E122-00-00 71-E122-00-00 71-E122-00-00 71-E122-00-00



Caja de conexión IP68 (1 entrada + 5 salidas) Ø 6,5 - 11mm, 6 polos  
Caixa de ligação IP68 (1 entrada + 5 saídas) Ø 6,5 - 11 mm, 6 polos

71-9199-05-05 71-9199-05-05 71-9199-05-05 71-9199-05-05 71-9199-05-05

	Gea Power LED Pro Ø220mm Efficiency	Gea Power LED Pro Ø220mm Comfort	Gea Power LED Pro Ø300mm Efficiency	Gea Power LED Pro Ø300mm Comfort
				

**Accesorios de fijación**  
**Accessórios de fixação**

	Caja de empotrar Caixa de encastrar	Included	Included	Included	Included
-----------------------------------------------------------------------------------	----------------------------------------	----------	----------	----------	----------

**Accesorios de conexión**  
**Accessórios de conexão**

	Conector IP68 (1 entrada + 1 salida) Ø 6 - 17mm, 5 polos Conetor IP68 (1 entrada + 1 saída) Ø 6 - 17 mm, 5 polos	71-E361-00-00	71-E361-00-00	71-E361-00-00	71-E361-00-00
	Conector anticondensación IP68 (1 entrada + 1 salida) Ø 5,5 - 12mm, 4 polos Conetor anticondensação IP68 (1 entrada + 1 saída) Ø 5,5 - 12 mm, 4 polos	71-E112-00-00	71-E112-00-00	71-E112-00-00	71-E112-00-00
	Conector anticondensación IP68 (1 entrada + 3 salidas) Ø 5,5 - 12mm, 4 polos Conetor anticondensação IP68 (1 entrada + 3 saídas) Ø 5,5 - 12 mm, 4 polos	71-E122-00-00	71-E122-00-00	71-E122-00-00	71-E122-00-00
	Caja de conexión IP68 (1 entrada + 5 salidas) Ø 6,5 - 11mm, 6 polos Caixa de ligação IP68 (1 entrada + 5 saídas) Ø 6,5 - 11 mm, 6 polos	71-9199-05-05	71-9199-05-05	71-9199-05-05	71-9199-05-05

# Gea Cob



Solución con múltiples accesorios,  
ideal para vegetación

Solução com múltiplos acessórios,  
ideal para vegetação



### Máxima durabilidad Máxima durabilidade

Carcasa de doble protección para aislar la electrónica de la luminaria y ofrecer una mayor protección, evitando que se dañe el LED o el driver.

Carcaça de dupla proteção para isolar a eletrônica da luminária e oferecer uma maior proteção, evitando que o LED ou o driver sejam danificados.

## Gea Cob

IK 10		50000h L80 B20	2 MacAdam	BODY MAT AISI316,POLI	DIF MAT GLA
----------	--	-------------------	--------------	--------------------------	----------------

### Gea Cob 125mm

IP 65			SEA SIDE SUITABLE		±15°	360°			
----------	--	--	----------------------	--	------	------	--	--	--

CA

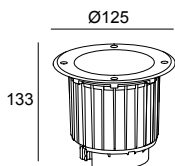

LED							
K	CRI	W Total	Real Lm	Optics	Code		
2700	80	10.5	869	17°;53°	55-9906 - CA - CK		ON-OFF 100-240V
3000	80	10.5	869	17°;53°	55-9906 - CA - CL		ON-OFF 100-240V
4000	80	10.5	934	17°;53°	55-9906 - CA - CM		ON-OFF 100-240V



## Gea Cob 185mm

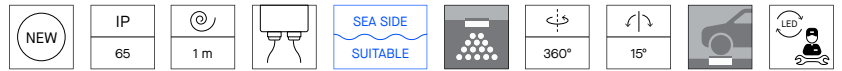

CA

OUTDOOR

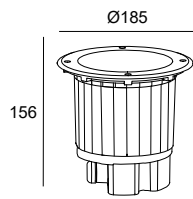

LED							
K	CRI	W Total	Real Lm	Optics	Code		
2700	80	17.6	1630	21°;54°	<b>55-9907</b> <b>55-E078</b>	- CA - CK	ON-OFF 100-240V
3000	80	17.6	1630	21°;54°	<b>55-9907</b> <b>55-E078</b>	- CA - CL	ON-OFF 100-240V
4000	80	17.6	1752	21°;54°	<b>55-9907</b> <b>55-E078</b>	- CA - CM	ON-OFF 100-240V

## Gea Cob 223mm



CA

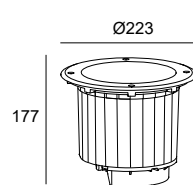

LED							
K	CRI	W Total	Real Lm	Optics	Code		
2700	80	26.7	2262	18°;53°	<b>55-9909</b> <b>55-E079</b>	- CA - CK	ON-OFF 100-240V
3000	80	26.7	2262	18°;53°	<b>55-9909</b> <b>55-E079</b>	- CA - CL	ON-OFF 100-240V
4000	80	26.7	2423	18°;53°	<b>55-9909</b> <b>55-E079</b>	- CA - CM	ON-OFF 100-240V

## Gea Cob 300mm

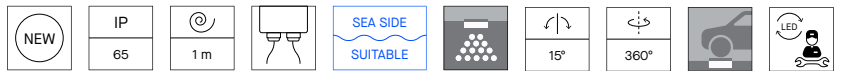

CA

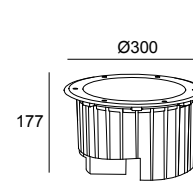

LED							
K	CRI	W Total	Real Lm	Optics	Code		
2700	80	35	3681	18°;51°	<b>55-9972</b> <b>55-E080</b>	- CA - CK	ON-OFF 100-240V
3000	80	35	3681	18°;51°	<b>55-9972</b> <b>55-E080</b>	- CA - CL	ON-OFF 100-240V
4000	80	35	3927	18°;51°	<b>55-9972</b> <b>55-E080</b>	- CA - CM	ON-OFF 100-240V

EMBOTRABLES SUELO | ENCASTRÁVEIS NO SOLO

Gea Cob 125mm

Gea Cob 185mm

Gea Cob 223mm

Gea Cob 300mm



## Accesorios ópticos

### Acessórios óticos

	Set de 2 reflectores (21° y 54°) Set de 2 refletores (21° e 54°)	-	Included	-	-
	Panel de abeja Favo de abelha	Included	Included	Included	Included
	Filtro asimétrico Filtro assimétrico	Included	Included	Included	Included
	Set de 2 reflectores (18° y 51°) Set de 2 refletores (18° e 51°)	-	-	-	Included
	Set de 2 reflectores (17° y 53°) Set de 2 refletores (17° e 53°)	Included	-	-	-
	Set de 2 reflectores (18° y 53°) Set de 2 refletores (18° e 53°)	-	Included	Included	-

## Accesorios de fijación

### Acessórios de fixação

	Caja de empotrar Caixa de encastrar	Included	Included	Included	Included
--	----------------------------------------	----------	----------	----------	----------

## Accesorios de conexión

### Acessórios de conexão

	Conector IP68 (1 entrada + 1 salida) Ø 6 - 17mm, 5 polos Conetor IP68 (1 entrada + 1 saída) Ø 6 - 17 mm, 5 polos	-	71-E361-00-00	71-E361-00-00	71-E361-00-00
	Conector anticondensación IP68 (1 entrada + 1 salida) Ø 5,5 - 12mm, 4 polos Conetor anticondensação IP68 (1 entrada + 1 saída) Ø 5,5 - 12 mm, 4 polos	71-E112-00-00	71-E112-00-00	71-E112-00-00	71-E112-00-00
	Conector anticondensación IP68 (1 entrada + 3 salidas) Ø 5,5 - 12mm, 4 polos Conetor anticondensação IP68 (1 entrada + 3 saídas) Ø 5,5 - 12 mm, 4 polos	71-E122-00-00	71-E122-00-00	71-E122-00-00	71-E122-00-00
	Caja de conexión IP68 (1 entrada + 5 salidas) Ø 6,5 - 11mm, 6 polos Caixa de ligação IP68 (1 entrada + 5 saídas) Ø 6,5 - 11 mm, 6 polos	71-9199-05-05	71-9199-05-05	71-9199-05-05	71-9199-05-05

# Gea Wall Washer



Solución para bañar fachadas  
Solução para washlight de fachadas

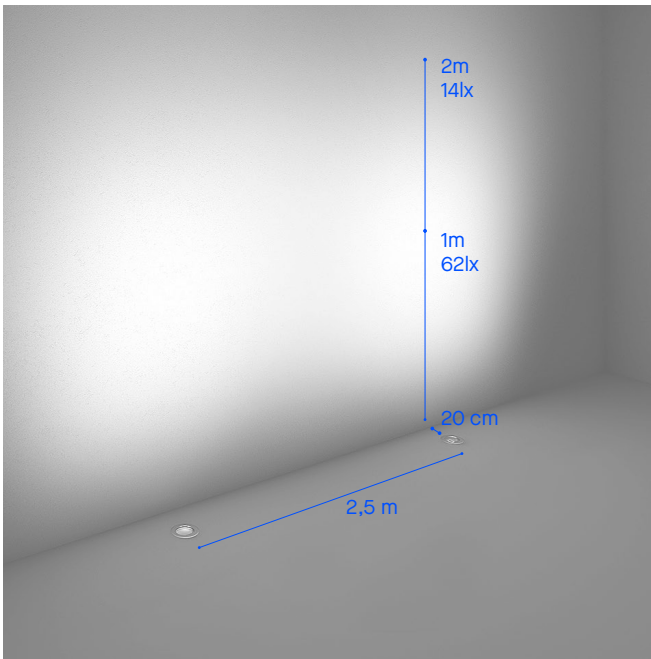

Ø 185mm (55-9908-CA-CM)

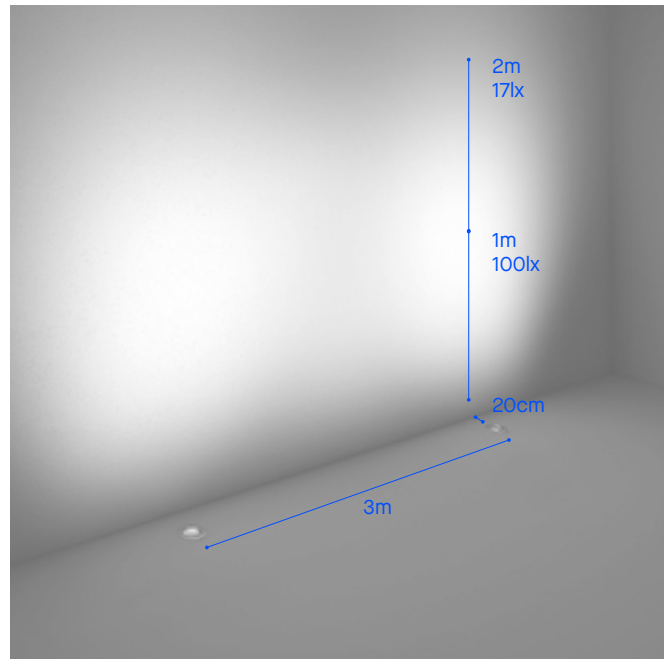

Ø 223mm (55-9910-CA-CM)

# Gea Wall Washer

IK 10		50000h L80 B20	3 MacAdam	BODY MAT AISI316,POLI	DIF MAT GLA
----------	--	-------------------	--------------	--------------------------	----------------

## Gea Wall Washer 185mm

	IP 65	 1 m		SEA SIDE SUITABLE		 360°		
--	----------	---------	--	----------------------	--	----------	--	--

CA

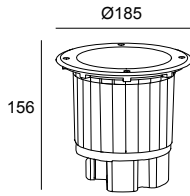
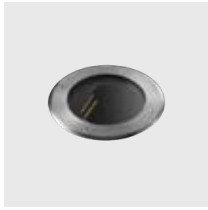

LED							
K	CRI	W Total	Real Lm	Optics	Code		
2700	80	18.5	618	81°	<b>55-E081</b> - CA - CK		DALI-2 100-240V
3000	80	18.5	618	81°	<b>55-9908</b> <b>55-E081</b> - CA - CL		ON-OFF 100-240V DALI-2 100-240V
4000	80	18.5	711	81°	<b>55-9908</b> <b>55-E081</b> - CA - CM		ON-OFF 100-240V DALI-2 100-240V

## Gea Wall Washer 225mm

	IP 65	 1 m		SEA SIDE SUITABLE		 360°		
--	----------	---------	--	----------------------	--	----------	--	--

CA

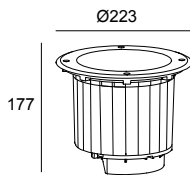

LED							
K	CRI	W Total	Real Lm	Optics	Code		
2700	80	27.5	1008	78°	<b>55-E082</b> - CA - CK		DALI-2 100-240V
3000	80	27.5	1008	78°	<b>55-9910</b> <b>55-E082</b> - CA - CL		ON-OFF 100-240V DALI-2 100-240V
4000	80	27.5	1109	78°	<b>55-9910</b> <b>55-E082</b> - CA - CM		ON-OFF 100-240V DALI-2 100-240V



**Accesorios de fijación**  
**Accessórios de fixação**



Caja de empotrar  
 Caixa de encastrar

Included

Included

**Accesorios de conexión**  
**Accessórios de conexão**



Conector IP68 (1 entrada + 1 salida) Ø 6 - 17mm, 5 polos  
 Conetor IP68 (1 entrada + 1 saída) Ø 6 - 17 mm, 5 polos

71-E361-00-00

71-E361-00-00



Conector anticondensación IP68 (1 entrada + 1 salida) Ø 5,5 - 12mm, 4 polos  
 Conetor anticondensação IP68 (1 entrada + 1 saída) Ø 5,5 - 12 mm, 4 polos

71-E112-00-00

71-E112-00-00



Conector anticondensación IP68 (1 entrada + 3 salidas) Ø 5,5 - 12mm, 4 polos  
 Conetor anticondensação IP68 (1 entrada + 3 saídas) Ø 5,5 - 12 mm, 4 polos

71-E122-00-00

71-E122-00-00



Caja de conexión IP68 (1 entrada + 5 salidas) Ø 6,5 - 11mm, 6 polos  
 Caixa de ligação IP68 (1 entrada + 5 saídas) Ø 6,5 - 11 mm, 6 polos

71-9199-05-05

71-9199-05-05

# Gea Compact



Solución para suelos  
con poca profundidad  
Solução para solos com  
pouca profundidade



130 mm

180 mm



# Gea Compact

IK 10		50000h L80 B20	3 MacAdam	BODY MAT AISI316,POLI	DIF MAT GLA
----------	--	-------------------	--------------	--------------------------	----------------

## Gea Compact Uplight Round 130mm

IP 65	BREEAM		SEA SIDE SUITABLE			$\pm 15^\circ$		LED	DRIVER
----------	--------	--	----------------------	--	--	----------------	--	-----	--------

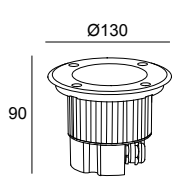

LED							
K	CRI	W Total	Real Lm	Optics	Code		
3000	80	8.9	460	26°	55-9663 - CA - CL	ON-OFF	100-240V
4000	80	8.9	460	26°	55-9663 - CA - CM	ON-OFF	100-240V

CA

## Gea Compact Uplight Round 180mm

IP 65	BREEAM		SEA SIDE SUITABLE			$\pm 15^\circ$		LED	DRIVER
----------	--------	--	----------------------	--	--	----------------	--	-----	--------

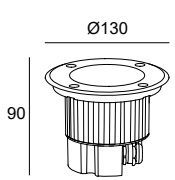

LED							
K	CRI	W Total	Real Lm	Optics	Code		
3000	80	11	796	17°	55-9665 - CA - CL	ON-OFF	100-240V
3000	80	22	1101	14°	55-9667 - CA - CL	ON-OFF	100-240V
4000	80	11	837	17°	55-9665 - CA - 37	ON-OFF	100-240V
4000	80	22	1167	14°	55-9667 - CA - CM	ON-OFF	100-240V

CA

Gea Compact Uplight Round 130mm



Gea Compact Uplight Round 180mm



### Accesorios ópticos Acessórios óticos



Filtro difusor  
Filtro difusor

Included

Included

### Accesorios de fijación Acessórios de fixação



Caja de empotrar  
Caixa de encastrar

Included

Included



# Gea Signaling



Solución para iluminación de señalización  
 Solução para iluminação de sinalização

## Gea Signaling

BODY MAT	DIF MAT
AISI316,POLI	GLA

### Gea Signaling 12V AC/DC 45mm

IP 65	IK 05		50000h L80 B20	3 MacAdam	 2.5 m	SEA SIDE SUITABLE			
----------	----------	--	-------------------	--------------	-----------	----------------------	--	--	--

54

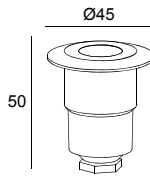

35 5-30 mm

LED						12V AC/DC
K	CRI	W	Real Lm	Optics	Code	
4000	80	0.5	12	68°	55-9768	- 54 - T2

### Gea Signaling 12V AC/DC 60mm

IP 65	IK 05		50000h L80 B20	3 MacAdam	 2.5 m	SEA SIDE SUITABLE			
----------	----------	--	-------------------	--------------	-----------	----------------------	--	--	--

54

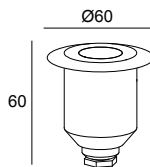

50 5-30 mm

LED						12V AC/DC
K	CRI	W	Real Lm	Optics	Code	
4000	80	1	23	68°	55-9769	- 54 - T2

## Gea Signaling 100-240V 60mm

IK
10

LOW FLICKER
----------------



50000h L80 B20
-------------------

3 MacAdam
--------------

2.5 m
-------

SEA SIDE SUITABLE
----------------------



54

OUTDOOR

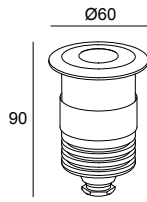

50 0-20 mm

LED						
K	CRI	W Total	Real Lm	Code		
3000	80	2.2	52	55-9620 - 54 - CL	ON-OFF	
4000	80	2.2	52	55-9620 - 54 - T2	ON-OFF	

Gea Signaling 12V  
AC/DC 45mm



Gea Signaling 12V  
AC/DC 60mm



Gea Signaling  
100-240V 60mm



### Fuentes de alimentación Fontes de alimentação

P. 1166

ON-OFF  
IP20

71-5489-00-00  
Min.1 - Max.18

71-5489-00-00  
Min.1 - Max.18

71-5489-00-00  
Min.1 - Max.36

### Accesorios ópticos Acessórios óticos



Difusor 3000K  
Difusor 3000K

-

-

Included



Filtros de color  
Filtros de cor

Included

Included

Included



Difusor 3700K  
Difusor 3700K

Included

Included

-

### Accesorios de fijación Acessórios de fixação



Caja de empotrar  
Caixa de encastrar

Included

Included

Included

### Accesorios de conexión Acessórios de conexão



Conector anticondensación IP68 (1 entrada + 1 salida) Ø 5,5 - 12mm, 4 polos  
Conetor anticondensação IP68 (1 entrada + 1 saída) Ø 5,5 - 12 mm, 4 polos

71-E112-00-00

71-E112-00-00

71-E112-00-00



Conector anticondensación IP68 (1 entrada + 3 salidas) Ø 5,5 - 12mm, 4 polos  
Conetor anticondensação IP68 (1 entrada + 3 saídas) Ø 5,5 - 12 mm, 4 polos

71-E122-00-00

71-E122-00-00

71-E122-00-00

Caja de conexión IP67 (1 entrada + 2 salidas) Ø 6 - 7,5mm, 3 polos  
Caixa de ligação IP67 (1 entrada + 2 saídas) Ø 6 - 7,5 mm, 3 polos

71-9262-05-05

71-9262-05-05

71-9262-05-05

Caja de conexión IP68 (1 entrada + 5 salidas) Ø 6,5 - 11mm, 6 polos  
Caixa de ligação IP68 (1 entrada + 5 saídas) Ø 6,5 - 11 mm, 6 polos

71-9199-05-05

71-9199-05-05

71-9199-05-05

EMPOTRABLES SUELO | ENCASTRÁVEIS NO SOLO

# Gea Technopolymer



Solución para instalar directamente en la tierra, sin usar hormigón.  
Solução para instalar diretamente na terra, sem usar betão.





BODY MAT  
AISI316,POLI

DIF MAT  
GLA

IK  
10



SEA SIDE  
SUITABLE



## Gea Technopolymer Cob 125mm

IP  
65



BREEAM

50000h  
L80 B20

2  
MacAdam

1 m

15°

360°



CA

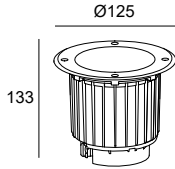
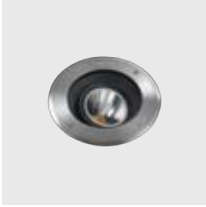

LED

K	CRI	W Total	Real Lm	Optics	Code	
3000	80	7.7	568	17°;53°	<b>55-E083 - CA - CL</b>	ON-OFF 100-240V

## Gea Technopolymer Cob 185mm

IP  
65



BREEAM

50000h  
L80 B20

2  
MacAdam

1 m

±15°

360°



CA

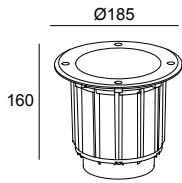

LED

K	CRI	W Total	Real Lm	Optics	Code	
3000	80	12.7	1276	21°;54°	<b>55-E038 - CA - CL</b>	ON-OFF 100-240V

Gea Technopolymer GU10 Square

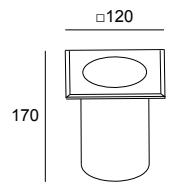
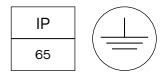

GU10	
<b>W</b>	<b>Code</b>
Max. 8	55-9281 - CA - 37

Gea Technopolymer GU10 Round

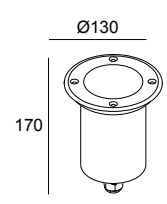
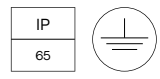

GU10	
<b>W</b>	<b>Code</b>
Max. 8	55-9280 - CA - 37

Gea Technopolymer GU10 Round Deep

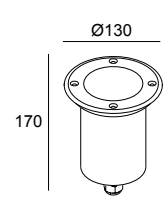

GU10	
<b>W</b>	<b>Code</b>
Max. 8	55-9380 - CA - 37



Gea  
Technopolymer  
Cob 125mm







Gea  
Technopolymer  
Cob 185mm



Gea  
Technopolymer  
GU10 Square



## Accesorios ópticos Acessórios óticos

	Set de 2 reflectores (21° y 54°) Set de 2 refletores (21° e 54°)	-	Included	-
	Panel de abeja Favo de abelha	Included	Included	-
	Filtro asimétrico Filtro assimétrico	Included	Included	-
	Set de 2 reflectores (17° y 53°) Set de 2 refletores (17° e 53°)	Included	-	-

## Accesorios de fijación Acessórios de fixação

	Caja de empotrar Caixa de encastrar	Included	Included	Included
-----------------------------------------------------------------------------------	----------------------------------------	----------	----------	----------





## Accesorios de conexión Acessórios de conexão

	Conector anticondensación IP68 (1 entrada + 1 salida) Ø 5,5 - 12mm, 4 polos Conetor anticondensação IP68 (1 entrada + 1 saída) Ø 5,5 - 12 mm, 4 polos	<b>71-E112-00-00</b>	<b>71-E112-00-00</b>	-
	Conector anticondensación IP68 (1 entrada + 3 salidas) Ø 5,5 - 12mm, 4 polos Conetor anticondensação IP68 (1 entrada + 3 saídas) Ø 5,5 - 12 mm, 4 polos	<b>71-E122-00-00</b>	<b>71-E122-00-00</b>	-
	Caja de conexión IP68 (1 entrada + 5 salidas) Ø 6,5 - 11mm, 6 polos Caixa de ligação IP68 (1 entrada + 5 saídas) Ø 6,5 - 11 mm, 6 polos	<b>71-9199-05-05</b>	<b>71-9199-05-05</b>	-







**Accesorios ópticos**  
Acessórios óticos

	Set de 2 reflectores (21° y 54°) Set de 2 refletores (21° e 54°)	-	-
	Panel de abeja Favo de abelha	-	-
	Filtro asimétrico Filtro assimétrico	-	-
	Set de 2 reflectores (17° y 53°) Set de 2 refletores (17° e 53°)	-	-

**Accesorios de fijación**  
Acessórios de fixação

	Caja de empotrar Caixa de encastrar	Included	Included
-----------------------------------------------------------------------------------	----------------------------------------	----------	----------

**Accesorios de conexión**  
Acessórios de conexão

	Conector anticondensación IP68 (1 entrada + 1 salida) Ø 5,5 - 12mm, 4 polos Conetor anticondensação IP68 (1 entrada + 1 saída) Ø 5,5 - 12 mm, 4 polos	-	-
	Conector anticondensación IP68 (1 entrada + 3 salidas) Ø 5,5 - 12mm, 4 polos Conetor anticondensação IP68 (1 entrada + 3 saídas) Ø 5,5 - 12 mm, 4 polos	-	-
	Caja de conexión IP68 (1 entrada + 5 salidas) Ø 6,5 - 11mm, 6 polos Caixa de ligação IP68 (1 entrada + 5 saídas) Ø 6,5 - 11 mm, 6 polos	-	-



+ Kay



## Esencial con todos los detalles cuidados

## Essencial com todos os detalhes cuidados

Esta colección es ideal para proyectos que necesitan una solución asequible sin renunciar a la máxima fiabilidad y confort visual. Kay no permite basculación del grupo óptico, pero sus accesorios incluidos y la calidad de sus materiales lo convierten en una colección de empotrados de suelo ideal para la mayoría de proyectos.

Esta coleção é ideal para projetos que requerem uma solução acessível sem sacrificar a máxima fiabilidade e conforto visual. Kay não permite a basculação do grupo ótico, mas os seus acessórios incluídos e a qualidade dos seus materiais fazem dela uma coleção de encastrar de chão ideal para a maioria dos projetos.

185 mm



125 mm



80 mm







# Kay

BODY MAT	DIF MAT		50000h	3
AL, AISI316	GL TMP		L80 B20	MacAdam

## Kay 80mm

IP	IK	BREEAM		SEA SIDE SUITABLE			LED	DRIVER
65	10		1 m					

CA

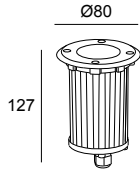

LED							
K	CRI	W Total	Real Lm	Optics	Code		
3000	80	5.7	400	30°	55-E010 - CA - CL	ON-OFF 100-240V	

## Kay 125mm

IP	IK	BREEAM		SEA SIDE SUITABLE			LED	DRIVER
65	10		1 m					

CA

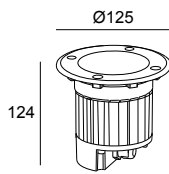

LED							
K	CRI	W Total	Real Lm	Optics	Code		
3000	80	11.5	925	34°	55-E011 - CA - CL	ON-OFF 100-240V	

## Kay 185mm

NEW	IP	BREEAM		SEA SIDE SUITABLE			LED	DRIVER
	65		1 m					

CA

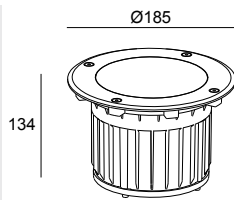

LED							
K	CRI	W Total	Real Lm	Optics	Code		
3000	80	23.6	1890	35°	55-E020 - CA - CL	ON-OFF 100-240V	



Kay 80mm

Kay 125mm

Kay 185mm



OUTDOOR



### Accesorios ópticos

#### Accessórios óticos



Antideslumbrante  
Antideslumbramento

Included

Included

Included



Difusor wall washer  
Wall washer diffuser

Included

Included

Included

### Accesorios de fijación

#### Accessórios de fixação



Caja de empotrar  
Caixa de encastrar

Included

Included

Included

### Accesorios de conexión

#### Accessórios de conexão



Conector anticondensación IP68 (1 entrada + 1 salida) Ø 5,5 - 12mm, 4 polos  
Conetor anticondensação IP68 (1 entrada + 1 saída) Ø 5,5 - 12 mm, 4 polos

71-E112-00-00

71-E112-00-00

71-E112-00-00



Conector anticondensación IP68 (1 entrada + 3 salidas) Ø 5,5 - 12mm, 4 polos  
Conetor anticondensação IP68 (1 entrada + 3 saídas) Ø 5,5 - 12 mm, 4 polos

71-E122-00-00

71-E122-00-00

71-E122-00-00



Caja de conexión IP68 (1 entrada + 5 salidas) Ø 6,5 - 11mm, 6 polos  
Caixa de ligação IP68 (1 entrada + 5 saídas) Ø 6,5 - 11 mm, 6 polos

71-9199-05-05

71-9199-05-05

71-9199-05-05

EMPOTRABLES SUELO | ENCASTRÁVEIS NO SOLO



+ Ios



Confort visual en un perfil integrado en la arquitectura

Conforto visual num perfil integrado na arquitetura

De diseño compacto, los empotrados de suelo IOS resultan ideales para iluminar elementos de dimensiones reducidas, como entradas, columnas o esculturas, ya que emiten un haz de luz controlado y con confort, a la vez que su perfil pasa prácticamente desapercibido.

De design compacto, os encastrados de chão IOS são ideais para iluminar elementos de dimensões reduzidas, como entradas, colunas ou esculturas, já que emitem um feixe de luz controlado e com conforto, ao mesmo tempo que o seu perfil passa praticamente despercebido.

#### Modelos simétricos con panel de abeja antideslumbrante

Modelos simétricos com painel de abelha antideslumbrante

#### Modelo asimétrico con disposición hundida de los LEDs

Modelo assimétrico com disposição afundada dos LEDs

30 mm

50 mm

77 mm









Luz simétrica y asimétrica  
con gran confort visual  
Luz simétrica e  
assimétrica com grande  
conforto visual

**Luz simétrica**  
Luz simétrica

Haz de luz de ángulo mediano ideal  
para iluminación de acento.  
Feixe de luz de ângulo médio ideal para  
iluminação de realce.



**Luz asimétrica**  
Luz assimétrica

Haz de luz orientado hacia un lado ideal  
para bañar pequeñas fachadas.  
Feixe de luz orientado para um lado  
ideal para washlight de pequenas  
fachadas.



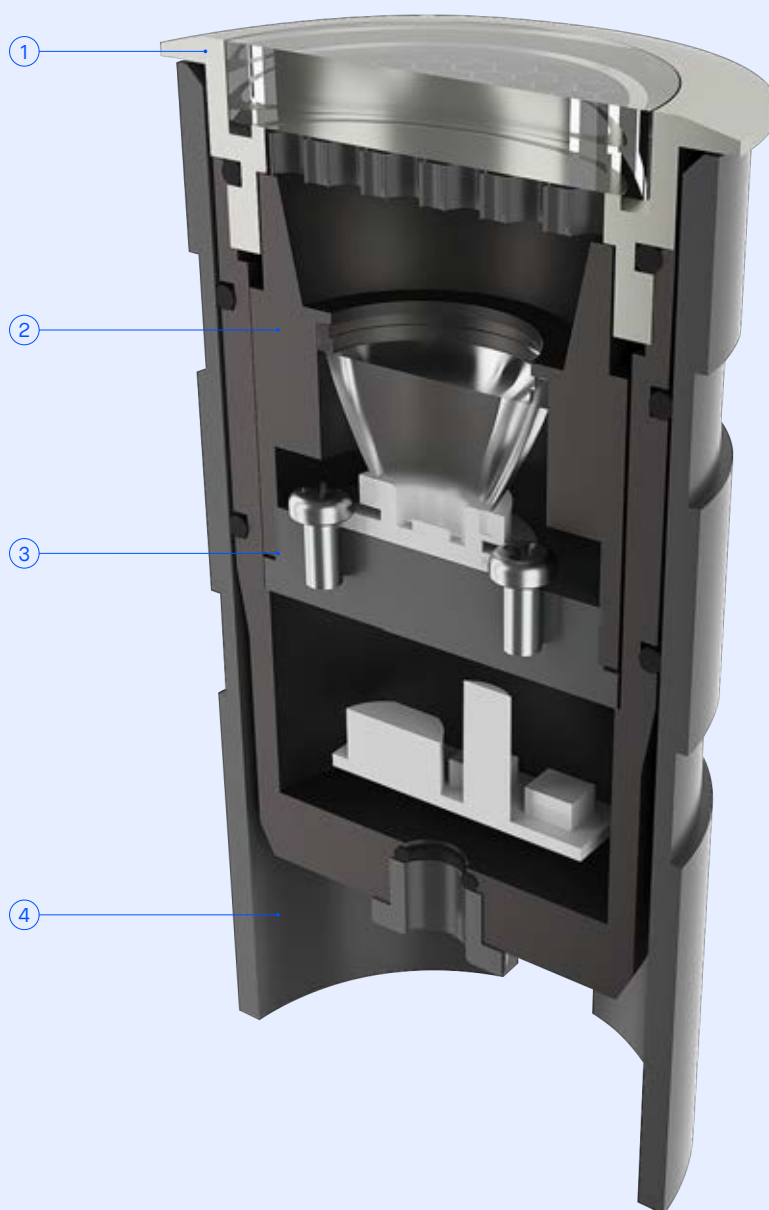

① **Marco de acero inoxidable AISI16** que permite la durabilidad del producto en ambientes marinos.  
**Aro de aço inoxidável AISI16** que permite a durabilidade do produto em ambientes marinhos.

② **La disposición hundida de los LEDs** garantizan un gran confort visual.  
**A disposição afundada dos LEDs** garantem um grande conforto visual.

③ **Cuerpo fabricado en aluminio** torneado de alta pureza que maximiza la vida útil del producto.  
**Corpo fabricado em alumínio** torneado de alta pureza que maximiza la vida útil del producto.

④ **Prensaestopas especial antiapertura** que aseguran la estanqueidad y la fiabilidad de la luminaria.  
**Bucins especiais antiabertura** que asseguram a estanqueidade e a fiabilidade da luminária.

BODY MAT
AISI316

DIF MAT
GLA



50000h
L80 B20

3
MacAdam

Ios Symmetrical Ø30mm

IP
65

IK
05

⊙
2 m

SEA SIDE  
SUITABLE



●  
CA

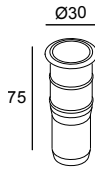

LED						24-48 VDC
K	CRI	W	Real Lm	Optics	Code	
3000	80	2	94	29°	55-E148 - CA - CL	

Ios Symmetrical Ø50mm

IP
65

IK
10

⊙
2 m

SEA SIDE  
SUITABLE



●  
CA

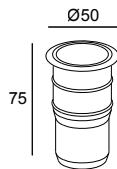

LED						24-48 VDC
K	CRI	W	Real Lm	Optics	Code	
3000	80	4	185	21°	55-E149 - CA - CL	

Ios Asymmetrical Ø77mm

IP
65

IK
10

⊙
2 m



SEA SIDE  
SUITABLE

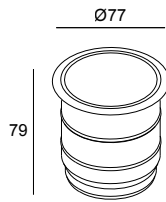

●  
CA











LED						24-48 VDC
K	CRI	W	Real Lm	Optics	Code	
3000	80	5.8	203	38°	55-E150 - CA - CL	

los Symmetrical Ø30mm	los Symmetrical Ø50mm	los Asymmetrical Ø77mm
		

**Fuentes de alimentación**  
Fontes de alimentação



P. 1166

 ON-OFF IP67	<b>71-E159-00-00</b>  Min.1 - Max.13	<b>71-E159-00-00</b>  Min.1 - Max.13	<b>71-E159-00-00</b>  Min.1 - Max.8
 Fuente de alimentación estanca con conectores IP67 Fonte de alimentação estanque com conectores IP67	<b>71-E101-05-05</b>  Min.1 - Max.4	<b>71-E101-05-05</b>  Min.1 - Max.4	<b>71-E101-05-05</b>  Min.1 - Max.3

**Accesorios de fijación**  
Acessórios de fixação

Caja de empotrar Caixa de encastrar	Included	Included	Included
----------------------------------------	----------	----------	----------

**Accesorios de conexión**  
Acessórios de conexão

 Conector anticondensación IP68 (1 entrada + 1 salida) Ø 5,5 - 12mm, 4 polos Conetor anticondensação IP68 (1 entrada + 1 saída) Ø 5,5 - 12 mm, 4 polos	<b>71-E112-00-00</b>	<b>71-E112-00-00</b>	<b>71-E112-00-00</b>
 Conector anticondensación IP68 (1 entrada + 3 salidas) Ø 5,5 - 12mm, 4 polos Conetor anticondensação IP68 (1 entrada + 3 saídas) Ø 5,5 - 12 mm, 4 polos	<b>71-E122-00-00</b>	<b>71-E122-00-00</b>	<b>71-E122-00-00</b>
 Caja de conexión IP68 (1 entrada + 5 salidas) Ø 6,5 - 11mm, 6 polos Caixa de ligação IP68 (1 entrada + 5 saídas) Ø 6,5 - 11 mm, 6 polos	<b>71-9199-05-05</b>	<b>71-9199-05-05</b>	<b>71-9199-05-05</b>

# Rim



+ Rim



## Calidad y resistencia en iluminación por puntos Qualidade e resistência na iluminação por pontos

La iluminación de señalización por puntos de luz es perfecta para destacar determinadas zonas estratégicas y para avisar cuando hay escalones, pendientes o zonas de agua. La versatilidad de Rim la convierten en una opción ideal en proyectos con este tipo de aplicación, donde se requiere una calidad y resistencia sobresaliente.

A iluminação de sinalização por pontos de luz é perfeita para destacar determinadas zonas estratégicas e para avisar quando há degraus, declives ou zonas de água. A versatilidade de Rim torna-a uma escolha ideal em projetos com este tipo de aplicação, onde se exige uma qualidade e resistência excepcionais.

Ultra compacta con sólo  
20mm de diámetro  
Ultracompacta  
com apenas 20mm  
de diâmetro

Instalación en pared o suelo  
Instalação na parede ou chão

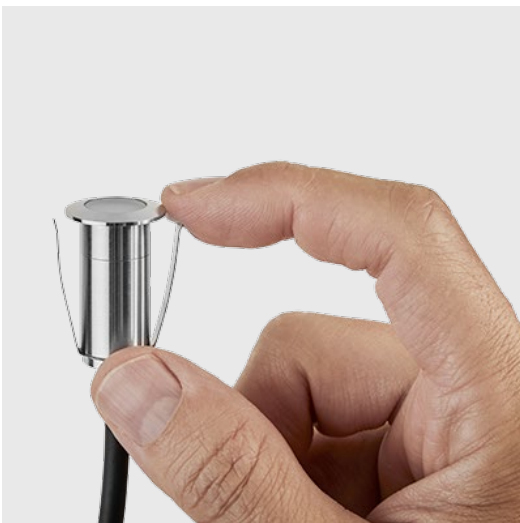







# Rim

BODY MAT
AISI316

DIF MAT
GLA



50000h
L80 B20

## Rim 20mm

IP
65

IK
10

3
MacAdam

1 m

SEA SIDE  
SUITABLE



●  
CA

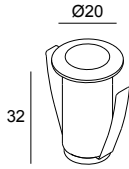

LED					24VDC
K	CRI	W	Real Lm	Code	
3000	80	0.5	3	55-E006 - CA - CL	
4000	80	0.5	4	55-E006 - CA - CM	

17

## Rim 46mm

IP
66

IK
10

1 m

SEA SIDE  
SUITABLE



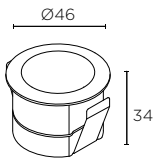

●  
CA



LED					24VDC
K	CRI	W	Real Lm	Code	
3000	80	1	17	55-E151 - CA - CL	
4000	80	1	17	55-E151 - CA - CM	
Blue		1	3	55-E151 - CA - 11	

40



	Rim 20mm	Rim 46mm
		

**Fuentes de alimentación** P. 1166  
**Fontes de alimentação**

 ON-OFF IP67	<b>71-E158-00-00</b>  Min.1 - Max.45	<b>71-E158-00-00</b>  Min.1 - Max.14
 DALI2 IP67	<b>71-E098-00-00</b>  Min.1 - Max.30	<b>71-E098-00-00</b>  Min.1 - Max.30
 Fuente de alimentación estanca con conectores IP67 Fonte de alimentação estanque com conectores IP67	<b>71-E101-05-05</b>  Min.1 - Max.39	<b>71-E101-05-05</b>  Min.1 - Max.13

**Controladores** P. 1166  
**Controladores**

 CASAMBI IP67	<b>71-A242-00-00</b>	<b>71-A242-00-00</b>
---------------------------------------------------------------------------------------------------	----------------------	----------------------

**Accesorios de fijación**  
**Accesórios de fixação**

 Caja de empotrar Caixa de encastrar	Included	Included
----------------------------------------------------------------------------------------------------------------------------	----------	----------

**Accesorios de conexión**  
**Accesórios de conexão**

 Conector IP67 (1 entrada + 1 saída) Ø 5,5 - 7,5mm, 3 polos Conetor IP67 (1 entrada + 1 saída) Ø 5,5 - 7,5 mm, 3 polos	<b>71-E510-00-00</b>	<b>71-E510-00-00</b>
 Conector IP67 (1 entrada + 2 salidas) Ø 5,5 - 7,5mm, 3 polos Conetor IP67 (1 entrada + 2 saídas) Ø 5,5 - 7,5 mm, 3 polos	<b>71-E511-00-00</b>	<b>71-E511-00-00</b>
Conector IP68 (1 entrada + 1 saída) Ø 5,5 - 11,5mm, 4 polos Conetor IP68 (1 entrada + 1 saída) Ø 5,5 - 11,5 mm, 4 polos	<b>71-E512-00-00</b>	<b>71-E512-00-00</b>
Conector IP68 (1 entrada + 2 salidas) Ø 5,5 - 11,5mm, 3 polos Conetor IP68 (1 entrada + 2 saídas) Ø 5,5 - 11,5 mm, 3 polos	<b>71-E513-00-00</b>	<b>71-E513-00-00</b>
 Conector anticondensación IP68 (1 entrada + 1 saída) Ø 5,5 - 12mm, 4 polos Conetor anticondensação IP68 (1 entrada + 1 saída) Ø 5,5 - 12 mm, 4 polos	<b>71-E112-00-00</b>	<b>71-E112-00-00</b>
 Conector anticondensación IP68 (1 entrada + 3 salidas) Ø 5,5 - 12mm, 4 polos Conetor anticondensação IP68 (1 entrada + 3 saídas) Ø 5,5 - 12 mm, 4 polos	<b>71-E122-00-00</b>	<b>71-E122-00-00</b>

# Pixel

Designed by LedsC4 Architectural



+ Pixel

## Señalización sin deslumbramiento Sinalização sem deslumbramento

La iluminación de señalización mediante efecto de luz en el suelo es ideal para orientar a los peatones en una zona de paso. Las propuestas tradicionales ofrecen luminarias de reducidas dimensiones que guían sin deslumbrar, Pixel va un va un paso más allá y lo hace con un gran confort visual y una robustez total, ya que es incluso apta para zonas de tránsito de vehículos.

A iluminação de sinalização através de um efeito de luz no chão é ideal para guiar os peões numa zona de passagem. As propostas tradicionais oferecem luminárias de reduzidas dimensões que guiam sem deslumbrar, Pixel vai um passo mais além e fá-lo com grande conforto visual e total robustez, já que é inclusive adequada para zonas com tráfego de veículos.



## Nuevos acabados metálicos Novos acabamentos metálicos



Acero inoxidable  
Aço inoxidável



Latón dorado  
Latão dourado



Cromo bruído  
Cromado polido

## Variedad de efectos de luz Variedade de efeitos de luz





Máximo confort visual  
Máximo conforto visual



Difusor escondido para iluminar sin deslumbrar.  
Difusor escondido para iluminar sem deslumbrar.

Instalación en pared o suelo  
Instalação na parede ou chão



BODY MAT	DIF MAT		50000h	3
AL,AISI316	GLA		L80 B20	MacAdam

## Pixel 1 window

IP	IK		SEA SIDE		(SC)
65	10	1 m	SUITABLE		

CA 17 18

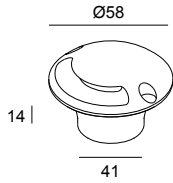
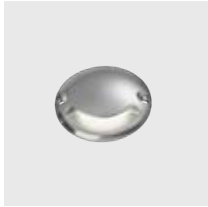

35

LED					
K	CRI	W	Real Lm	Code	
3000	80	3.4	10	55-E001	CA - I7 - CL I8
4000	80	3.4	10	55-E001	CA - I7 - CM I8

## Pixel 2 windows

IP	IK		SEA SIDE		(SC)
65	10	1 m	SUITABLE		

CA 17 18

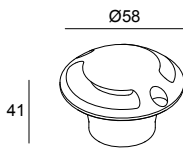
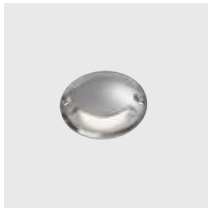

35

LED					
K	CRI	W	Real Lm	Code	
3000	80	3.4	21	55-E002	CA - I7 - CL I8
4000	80	3.4	22	55-E002	CA - I7 - CM I8

## Pixel 4 windows





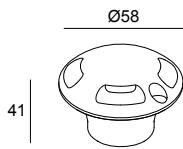
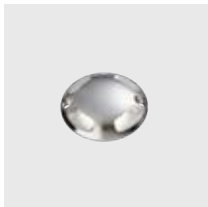

IP	IK		SEA SIDE		(SC)
65	10	1 m	SUITABLE		

CA 17 18



35

LED					
K	CRI	W	Real Lm	Code	
3000	80	3.4	15	55-E003	CA - I7 - CL I8
4000	80	3.4	16	55-E003	CA - I7 - CM I8

	ON-OFF IP67	<b>71-E159-00-00</b>  Min.1 - Max.15
	DALI2 IP67	<b>71-E098-00-00</b>  Min.1 - Max.15
	Fuente de alimentación estanca con conectores IP67 Fonte de alimentação estanque com conectores IP67	<b>71-E101-05-05</b>  Min.1 - Max.4

**Controladores**  
Controladores

	CASAMBI IP67	<b>71-A242-00-00</b>
-----------------------------------------------------------------------------------	-----------------	----------------------

**Accesorios de fijación**  
Acessórios de fixação

	Caja de empotrar Caixa de encastrar	Included
-----------------------------------------------------------------------------------	----------------------------------------	----------

**Accesorios de conexión**  
Acessórios de conexão

	Conector IP67 (1 entrada + 1 salida) Ø 5,5 - 7,5mm, 3 polos Conetor IP67 (1 entrada + 1 saída) Ø 5,5 - 7,5 mm, 3 polos	<b>71-E510-00-00</b>
	Conector IP67 (1 entrada + 2 salidas) Ø 5,5 - 7,5mm, 3 polos Conetor IP67 (1 entrada + 2 saídas) Ø 5,5 - 7,5 mm, 3 polos	<b>71-E511-00-00</b>
	Conector IP68 (1 entrada + 1 salida) Ø 5,5 - 11,5mm, 4 polos Conetor IP68 (1 entrada + 1 saída) Ø 5,5 - 11,5 mm, 4 polos	<b>71-E512-00-00</b>
	Conector IP68 (1 entrada + 2 salidas) Ø 5,5 - 11,5mm, 3 polos Conetor IP68 (1 entrada + 2 saídas) Ø 5,5 - 11,5 mm, 3 polos	<b>71-E513-00-00</b>
	Conector anticondensación IP68 (1 entrada + 1 salida) Ø 5,5 - 12mm, 4 polos Conetor anticondensação IP68 (1 entrada + 1 saída) Ø 5,5 - 12 mm, 4 polos	<b>71-E112-00-00</b>
	Conector anticondensación IP68 (1 entrada + 3 salidas) Ø 5,5 - 12mm, 4 polos Conetor anticondensação IP68 (1 entrada + 3 saídas) Ø 5,5 - 12 mm, 4 polos	<b>71-E122-00-00</b>
	Caja de conexión IP68 (1 entrada + 5 salidas) Ø 6,5 - 11mm, 6 polos Caixa de ligação IP68 (1 entrada + 5 saídas) Ø 6,5 - 11 mm, 6 polos	<b>71-9199-05-05</b>

Uplights de superficie / Uplights de superfície PAG. 127

## Facilidad de instalación Facilidade de instalação

La colección Xena dispone de módulos LED fácilmente reemplazables, 4 prensaestopas y un gran espacio interior para añadir componentes extra, por ejemplo protectores de sobretensión.

A coleção Xena dispõe de módulos LED facilmente substituíveis, 4 buçins e um grande espaço interior para adicionar componentes extra, por exemplo protetores de sobretensão.



Fuente de luz LED y E27.  
Fonte de luz LED e E27.

Para facilitar la instalación cuenta con 4 prensaestopas que pueden instalarse individualmente (2 para cables de Ø6 a Ø11 y 2 para cables de Ø8 a Ø16) y un gran espacio para las conexiones en el interior de la luminaria.

Para facilitar a instalação possui 4 buçins que podem ser instalados individualmente (2 para cabos de Ø6 a Ø11 e 2 para cabos de Ø8 a Ø16) e um grande espaço para as conexões no interior da luminária.



14

34

DL

E3

J6

Z5

60



## Xena LED

50000h	3	BODY MAT	DIF MAT	IP	IK														
L80 B20	MacAdam	AL,POLI	PC	66	10														

Z5\* 14\* 60\* 34 J6\* E3\* DL\*

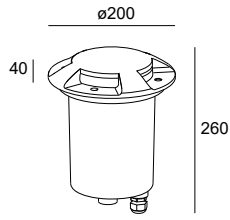

179

LED									
K	CRI	W Total	Real Lm	Code					
3000	80	5.7	70	55-E102	Z5				
					J6				
					E3				
					- DL - CL	ON-OFF	100-240V		
					14				
4000	80	5.7	74	55-E102	Z5				
					J6				
					E3				
					- DL - CM	ON-OFF	100-240V		
					14				
					60				
					34				

### Accesorios de fijación Acessórios de fixação



Caja de empotrar  
Caixa de encastrar

Included

## Xena E27 4 Sides

BODY MAT	DIF MAT	IP	IK															
AL,POLI	PC	65	10															

Z5\* 14\* 60\* 34 J6\* E3\* DL\*

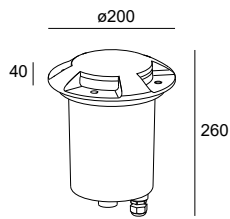

179

E27									
W	Code								
Max. 15	Z5								
	J6								
	E3								
	55-9428	- DL - M3							
	14								

### Accesorios de fijación Acessórios de fixação

Caja de empotrar  
Caixa de encastrar

Included

\* Consulte condiciones y plazos de entrega a nuestro equipo comercial.  
\* Consultar a nossa equipa comercial para informações sobre as condições e os prazos de entrega.



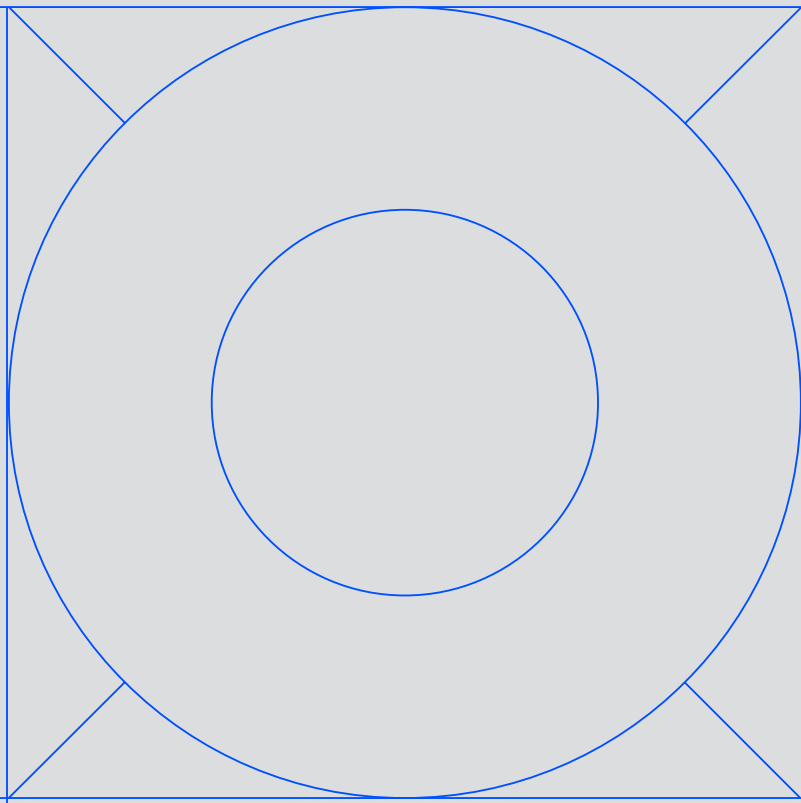

# Empotrables de techo

## Encastráveis de teto

Max  
736



Dako  
746

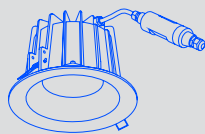

Gea  
752

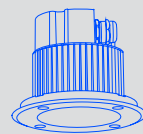

# Max

Designed by LedsC4 Architectural



+ Max

**FAMILIA/FAMILIA:** Downlights P.000. Spotlight P.000. Wall Fixtures P.000. Ceiling P.000

## Excelente control de la luz Excelente controlo da luz

El objetivo de los empotrables para techo Max es ofrecer el máximo control. Para conseguirlo utiliza una extensa gama de opciones: ópticas, potencias, regulaciones, temperaturas de color, acabados y accesorios ópticos. Combinando estas opciones se consigue un control total de la luz para adaptarla a todas las situaciones y necesidades.

O objetivo dos encastráveis para teto Max é oferecer o máximo controlo. Para o conseguir, utiliza uma extensa gama de opções: óticas, potências, regulações, temperaturas de cor, acabamentos e acessórios óticos. Ao combinar estas opções, consegue-se um controlo total da luz para a adaptar a todas as situações e necessidades.



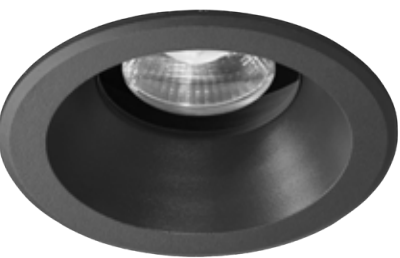
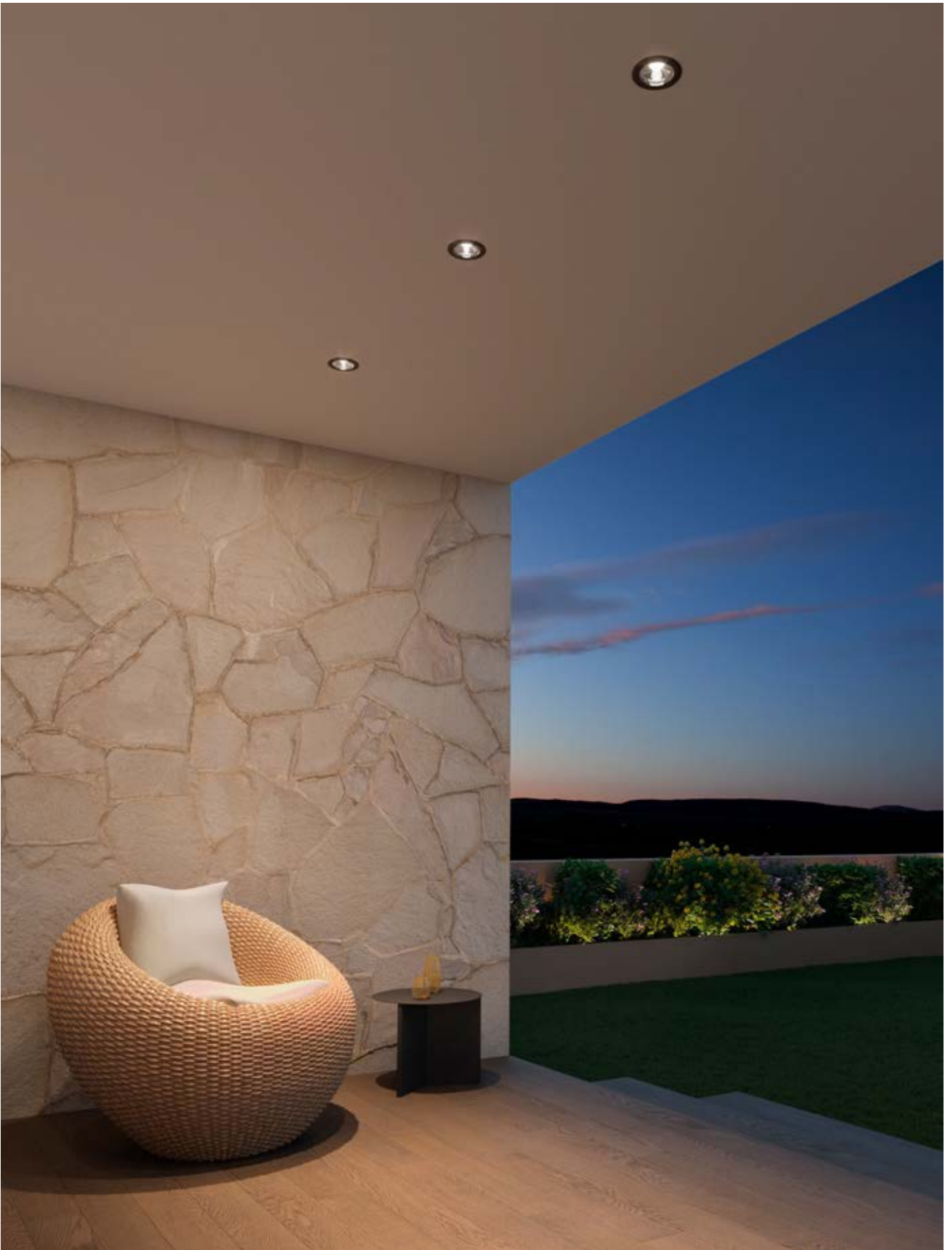

Excelente confort visual  
Excelente confort visual



OUTDOOR

EMPOTRABLES TECHO | ENCASTRÁVEIS DE TETO











BODY MAT	DIF MAT		50000h	2
AL	GLA		L80 B20	MacAdam

## Max Mini Downlights

NEW	IP	IK		SEA SIDE SUITABLE	
	66	04			

Ejemplo de código / Exemplo de código: **BA14-P2V8S1BBZ5**











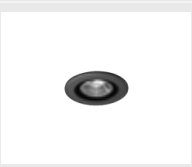



Model	W	K / Cri / Real lm	Optics	Source	Finishes
 <b>BA14 -</b> Redondo / Con marco Redondo / Com aro 45 mm $\varnothing$ 40  55 $\varnothing$ 47	Constant Current 500mA				
	<b>P2</b> 2.2W	<b>V8</b> 2700K / CRI 80 / 163 lm <b>W8</b> 3000K / CRI 80 / 185 lm <b>X8</b> 4000K / CRI 80 / 191 lm	<b>S1</b> 10° <b>S2</b> 15° <b>M3</b> 32° <b>F2</b> 53°	<b>BB</b> 3V/max.700mA	<b>Z5</b> <b>14*</b> <b>34*</b> <b>60*</b> <b>DL*</b> <b>E3*</b> <b>J6*</b>
 <b>BA15 -</b> Cuadrado / Con marco Cuadrado / Com aro 45 mm $\varnothing$ 40  55 47 / 47	Constant Voltage 24V				
	<b>P3</b> 2.5W	<b>V8</b> 2700K / CRI 80 / 94 lm <b>W8</b> 3000K / CRI 80 / 97 lm <b>X8</b> 4000K / CRI 80 / 87 lm	<b>S3</b> 19° <b>M3</b> 32° <b>F2</b> 51°	<b>BB</b> 24VDC	
 <b>BA16 -</b> Redondo / Profundo Redondo / profundo / com aro 20 mm $\varnothing$ 47  44 $\varnothing$ 58					

\* Consulte condiciones y plazos de entrega a nuestro equipo comercial.  
 \* Consultar a nossa equipa comercial para informações sobre as condições e os prazos de entrega.

# Max Medium Downlight

IP	IK	UGR		SEA SIDE SUITABLE	
66	10	<19	1 m		

Ejemplo de código / Exemplo de código: **AI14-P4V9S1BBZ5**



Model	W	K / Cri / Real lm	Optics	Source	Finishes	
 <p><b>AI14 -</b> Redondo / Con marco Redondo / Com aro ☞ 0-50 mm Ⓢ 65</p>  <p>70   Ø75</p>	<b>P4</b> 4W	<b>V9</b> 2700K / CRI 90 / 286 lm	<b>S1</b> 9°	<b>BB</b> 12V/max.350mA	<b>Z5</b>  <b>14*</b>  <b>34*</b>  <b>60*</b>  <b>DL*</b>  <b>E3*</b>  <b>J6*</b> 	
		<b>W9</b> 3000K / CRI 90 / 286 lm				
		<b>X9</b> 4000K / CRI 90 / 286 lm				
 <p><b>AI15 -</b> Cuadrado Cuadrado / Com aro ☞ 0-50 mm Ⓢ 65</p>  <p>70   75 75</p>	<b>P7</b> 6.5W	<b>V9</b> 2700K / CRI 90 / 519 lm	<b>S2</b> 17°	<b>BB</b> 18V/max.350mA		
		<b>W9</b> 3000K / CRI 90 / 459 lm				<b>M2</b> 27°
		<b>X9</b> 4000K / CRI 90 / 423 lm				
 <p><b>AI16 -</b> Redondo / Profundo Redondo / profundo / com aro ☞ 0-30 mm Ⓢ 85</p>  <p>80   Ø100</p>	<b>P6</b> 6W	<b>V9</b> 2700K / CRI 90 / 204 lm	<b>S1</b> 9°	<b>BB</b> 24VDC		
		<b>W9</b> 3000K / CRI 90 / 204 lm				
		<b>X9</b> 4000K / CRI 90 / 204 lm				
 <p><b>AI16 -</b> Redondo / Profundo Redondo / profundo / com aro ☞ 0-30 mm Ⓢ 85</p>  <p>80   Ø100</p>	<b>P8</b> 7.9W	<b>V9</b> 2700K / CRI 90 / 519 lm	<b>S2</b> 17°	<b>BB</b> 24VDC		
		<b>W9</b> 3000K / CRI 90 / 459 lm			<b>M2</b> 27°	
		<b>X9</b> 4000K / CRI 90 / 423 lm				<b>F1</b> 50°

\* Consulte condiciones y plazos de entrega a nuestro equipo comercial.  
\* Consultar a nossa equipa comercial para informações sobre as condições e os prazos de entrega.





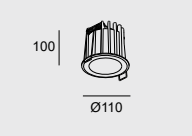
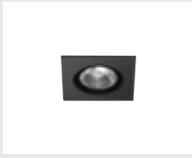
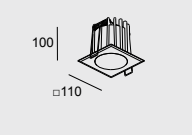

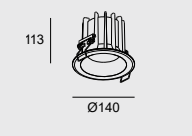
IP	IK	UGR		SEA SIDE SUITABLE	
66	10	<19	1 m		

Ejemplo de código / Exemplo de código: **AT14-18V9S3BBZ5**

Model	W	K / Cri / Real lm	Optics	Source	Finishes
 <b>AT14 -</b> Redondo / Con marco Redondo / Com aro 0-70 mm  95  100 Ø110	<b>18</b> 17.3W	<b>V9</b> 2700K / CRI 90 / 1844 lm	<b>S3</b> 21°	<b>BB</b> 36V/max.500mA	<b>Z5</b> <b>14*</b> <b>34*</b> <b>60*</b> <b>DL*</b> <b>E3*</b> <b>J6*</b>
		<b>W9</b> 3000K / CRI 90 / 2047 lm	<b>M3</b> 31°		
		<b>X9</b> 4000K / CRI 90 / 1803 lm	<b>F1</b> 40°		
 <b>AT15 -</b> Cuadrado Cuadrado / Com aro 0-70 mm  95  100 □110	<b>14</b> 13.8W	<b>V9</b> 2700K / CRI 90 / 1086 lm	<b>S3</b> 16°	<b>BB</b> 24VDC	
		<b>W9</b> 3000K / CRI 90 / 1076 lm	<b>M2</b> 28°		
		<b>X9</b> 4000K / CRI 90 / 1120 lm	<b>F2</b> 51°		
 <b>AT16 -</b> Redondo / Profundo Redondo / profundo / com aro 0-25 mm  125  113 Ø140					

\* Consulte condiciones y plazos de entrega a nuestro equipo comercial.  
 \* Consultar a nossa equipa comercial para informações sobre as condições e os prazos de entrega.

		Max Mini Downlight Constant Current	Max Mini Downlight Constant Voltage	Max Medium Downlight Constant Current P4	Max Medium Downlight Constant Current
					

## Drivers

### Driver



P. 1166

	ON-OFF IP20	<b>71-3308-00-00</b> Min.1 - Max.7	-	<b>71-7701-00-00</b>  Min.1 - Max.1	<b>71-7701-00-00</b>  Min.1 - Max.2
	ON-OFF IP68	<b>71-E014-00-00</b> Min.1 - Max.4	-	<b>71-E079-00-00</b>  Min.1 - Max.4	<b>71-E079-00-00</b>  Min.1 - Max.2
	1-10V DALI2 IP68	-	-	<b>71-E083-00-00</b> Min.1 - Max.4	<b>71-E083-00-00</b> Min.1 - Max.2
	1-10V DALI2 PUSH IP20	-	-	<b>71-4706-00-00</b> Min.1 - Max.6	<b>71-4706-00-00</b> Min.1 - Max.4
	DALI2 IP20	<b>71-6192-00-00</b> Min.1 - Max.8	-	-	-
	DALI2 IP68	<b>71-E080-00-00</b> Min.1 - Max.14	-	-	-
	CASAMBI IP20	<b>71-A260-00-00</b> Min.4 - Max.15	-	<b>71-A260-00-00</b>  Min.1 - Max.4	<b>71-A260-00-00</b>  Min.1 - Max.2
	Not Dimmable IP20	<b>71-A654-00-00</b>  Min.1 - Max.1	-	-	-

## Fuentes de alimentación

### Fontes de alimentação

P. 1166





	ON-OFF IP67	-	<b>71-E158-00-00</b> Min.1 - Max.9	-	-
	DALI2 IP67	-	<b>71-E098-00-00</b> Min.1 - Max.20	-	-
	Fuente de alimentación estanca con conectores IP67 Fonte de alimentação estanque com conectores IP67	-	<b>71-E101-05-05</b> Min.1 - Max.7	-	-

## Controladores

### Controladores

P. 1166













	CASAMBI IP67	-	<b>71-A242-00-00</b> Min.1 - Max.20	-	-
-------------------------------------------------------------------------------------	-----------------	---	----------------------------------------	---	---

	Max Medium Downlight Constant Voltage P6	Max Medium Downlight Constant Voltage	Max Big Downlight Constant Current	Max Big Downlight Constant Voltage
				



**Drivers** P. 1166  
**Driver**





	ON-OFF IP20	<b>71-7701-00-00</b>  Min.1 - Max.1	-	<b>71-3542-00-00</b>  Min.1 - Max.2	-
	ON-OFF IP68	<b>71-E079-00-00</b>  Min.1 - Max.4	-	<b>71-E079-00-00</b>  Min.1 - Max.1	-
	1-10V DALI2 IP68	<b>71-E083-00-00</b> Min.1 - Max.4	-	<b>71-E083-00-00</b>  Min.1 - Max.1	-
	1-10V DALI2 PUSH IP20	<b>71-4706-00-00</b> Min.1 - Max.6	-	<b>71-4706-00-00</b>  Min.1 - Max.2	-
	DALI2 IP20	-	-	-	-
	DALI2 IP68	-	-	-	-
	CASAMBI IP20	<b>71-A260-00-00</b>  Min.1 - Max.4	-	<b>71-A260-00-00</b>  Min.1 - Max.1	-
	Not Dimmable IP20	-	-	-	-

**Fuentes de alimentación** P. 1166  
**Fontes de alimentação**

	ON-OFF IP67	<b>71-E159-00-00</b>  Min.1 - Max.9	<b>71-E159-00-00</b>  Min.1 - Max.7	-	<b>71-6341-00-00</b>  Min.1 - Max.7
	DALI2 IP67	<b>71-E098-00-00</b>  Min.1 - Max.9	<b>71-E098-00-00</b>  Min.1 - Max.7	-	<b>71-E099-00-00</b>  Min.1 - Max.8
	Fuelle de alimentación estanca con conectores IP67 Fonte de alimentação estanque com conectores IP67	<b>71-E101-05-05</b>  Min.1 - Max.3	<b>71-E101-05-05</b>  Min.1 - Max.2	-	<b>71-E101-05-05</b>  Min.1 - Max.1





**Controladores** P. 1166  
**Controladores**

	CASAMBI IP67	<b>71-A242-00-00</b> Min.4 - Max.15	<b>71-A242-00-00</b> Min.4 - Max.12	-	<b>71-A242-00-00</b>  Min.1 - Max.8
-------------------------------------------------------------------------------------	-----------------	----------------------------------------	----------------------------------------	---	-----------------------------------------------------------------------------------------------------------------------------

	Max Mini Downlight Constant Current	Max Mini Downlight Constant Voltage	Max Medium Downlight Constant Current P4	Max Medium Downlight Constant Current
				

### Accesorios ópticos

#### Acessórios óticos

	Difusor wall washer (5u.) Wall washer diffuser (5u.)	71-E462-00-00	71-E462-00-00	71-E463-00-00	71-E463-00-00
	Panel de abeja (5u.) Painel de abelha (5u.)	71-E422-00-00	71-E422-00-00	71-E131-00-00	71-E131-00-00
	Difusor cuadrado (5u.) Difusor quadrado (5u.)	71-E421-00-00	71-E421-00-00	71-E135-00-00	71-E135-00-00
	Difusor elíptico (5u.) Difusor elíptico (5u.)	71-E420-00-00	71-E420-00-00	71-E141-00-00	71-E141-00-00
	Difusor opal (5u.) Difusor opal (5u.)	71-E419-00-00	71-E419-00-00	71-E133-00-00	71-E133-00-00

### Accesorios de fijación

#### Acessórios de fixação

	Caja de empotrar Caixa de encastrar	71-E467-00-00	71-E467-00-00	71-E467-00-00	71-E467-00-00
-------------------------------------------------------------------------------------	----------------------------------------	---------------	---------------	---------------	---------------

### Accesorios de conexión

#### Acessórios de conexão

	Conector IP67 (1 entrada + 1 salida) Ø 5,5 - 7,5mm, 3 polos Conetor IP67 (1 entrada + 1 saída) Ø 5,5 - 7,5 mm, 3 polos	71-E510-00-00	71-E510-00-00	71-E510-00-00	71-E510-00-00
	Conector IP67 (1 entrada + 2 salidas) Ø 5,5 - 7,5mm, 3 polos Conetor IP67 (1 entrada + 2 saídas) Ø 5,5 - 7,5 mm, 3 polos	71-E511-00-00	71-E511-00-00	71-E511-00-00	71-E511-00-00
	Conector IP68 (1 entrada + 1 salida) Ø 5,5 - 11,5mm, 4 polos Conetor IP68 (1 entrada + 1 saída) Ø 5,5 - 11,5 mm, 4 polos	71-E512-00-00	71-E512-00-00	71-E512-00-00	71-E512-00-00
	Conector IP68 (1 entrada + 2 salidas) Ø 5,5 - 11,5mm, 3 polos Conetor IP68 (1 entrada + 2 saídas) Ø 5,5 - 11,5 mm, 3 polos	71-E513-00-00	71-E513-00-00	71-E513-00-00	71-E513-00-00
	Conector anticondensación IP68 (1 entrada + 1 salida) Ø 5,5 - 12mm, 4 polos Conetor anticondensação IP68 (1 entrada + 1 saída) Ø 5,5 - 12 mm, 4 polos	71-E112-00-00	71-E112-00-00	71-E112-00-00	71-E112-00-00
	Conector anticondensación IP68 (1 entrada + 3 salidas) Ø 5,5 - 12mm, 4 polos Conetor anticondensação IP68 (1 entrada + 3 saídas) Ø 5,5 - 12 mm, 4 polos	71-E122-00-00	71-E122-00-00	71-E122-00-00	71-E122-00-00
	Caja de conexión IP68 (1 entrada + 5 salidas) Ø 6,5 - 11mm, 6 polos Caixa de ligação IP68 (1 entrada + 5 saídas) Ø 6,5 - 11 mm, 6 polos	-	-	71-9199-05-05	71-9199-05-05

Max Medium  
Downlight  
Constant Voltage  
P6



Max Medium  
Downlight  
Constant Voltage



Max Big Downlight  
Constant Current



Max Big Downlight  
Constant Voltage



### Accesorios ópticos Acessórios óticos

	Difusor wall washer (5u.) Wall washer diffuser (5u.)	71-E463-00-00	71-E463-00-00	71-E464-00-00	71-E464-00-00
	Panel de abeja (5u.) Painel de abelha (5u.)	71-E131-00-00	71-E131-00-00	71-E263-00-00	71-E263-00-00
	Difusor cuadrado (5u.) Difusor quadrado (5u.)	71-E135-00-00	71-E135-00-00	71-E262-00-00	71-E262-00-00
	Difusor elíptico (5u.) Difusor elíptico (5u.)	71-E141-00-00	71-E141-00-00	71-E261-00-00	71-E261-00-00
	Difusor opal (5u.) Difusor opal (5u.)	71-E133-00-00	71-E133-00-00	71-E260-00-00	71-E260-00-00

### Accesorios de fijación Acessórios de fixação

	Caja de empotrar Caixa de encastrar	71-E467-00-00	71-E467-00-00	71-E468-00-00	71-E468-00-00
--	----------------------------------------	---------------	---------------	---------------	---------------

### Accesorios de conexión Acessórios de conexão

	Conector IP67 (1 entrada + 1 salida) Ø 5,5 - 7,5mm, 3 polos Conetor IP67 (1 entrada + 1 saída) Ø 5,5 - 7,5 mm, 3 polos	71-E510-00-00	71-E510-00-00	71-E510-00-00	71-E510-00-00
	Conector IP67 (1 entrada + 2 salidas) Ø 5,5 - 7,5mm, 3 polos Conetor IP67 (1 entrada + 2 saídas) Ø 5,5 - 7,5 mm, 3 polos	71-E511-00-00	71-E511-00-00	71-E511-00-00	71-E511-00-00
	Conector IP68 (1 entrada + 1 salida) Ø 5,5 - 11,5mm, 4 polos Conetor IP68 (1 entrada + 1 saída) Ø 5,5 - 11,5 mm, 4 polos	71-E512-00-00	71-E512-00-00	71-E512-00-00	71-E512-00-00
	Conector IP68 (1 entrada + 2 salidas) Ø 5,5 - 11,5mm, 3 polos Conetor IP68 (1 entrada + 2 saídas) Ø 5,5 - 11,5 mm, 3 polos	71-E513-00-00	71-E513-00-00	71-E513-00-00	71-E513-00-00
	Conector anticondensación IP68 (1 entrada + 1 salida) Ø 5,5 - 12mm, 4 polos Conetor anticondensação IP68 (1 entrada + 1 saída) Ø 5,5 - 12 mm, 4 polos	71-E112-00-00	71-E112-00-00	71-E112-00-00	71-E112-00-00
	Conector anticondensación IP68 (1 entrada + 3 salidas) Ø 5,5 - 12mm, 4 polos Conetor anticondensação IP68 (1 entrada + 3 saídas) Ø 5,5 - 12 mm, 4 polos	71-E122-00-00	71-E122-00-00	71-E122-00-00	71-E122-00-00
	Caja de conexión IP68 (1 entrada + 5 salidas) Ø 6,5 - 11mm, 6 polos Caixa de ligação IP68 (1 entrada + 5 saídas) Ø 6,5 - 11 mm, 6 polos	71-9199-05-05	71-9199-05-05	71-9199-05-05	71-9199-05-05

# Dako

Designed by LedsC4 Architectural



## Un downlight LED polivalente Um downlight LED polivalente

Sus altas prestaciones, las distintas posibilidades de instalación y, sobre todo, los tres ángulos de luz que permite escoger durante su instalación, hacen de Dako la solución ideal cuando se busca un empotrado de techo polivalente.

As suas altas prestações, as diversas possibilidades de instalação e, sobretudo, os três ângulos de luz que pode escolher durante a sua instalação, fazem de Dako a solução ideal quando se pretende um encastrado de teto polivalente.

Fixed



Adjustable



Incluye driver IP67 remoto.  
Inclui driver IP67 remoto.



## Alto confort visual y UGR < 13 Alto conforto visual e UGR < 13

Los reflectores se sitúan en un nivel inferior, evitando así el deslumbramiento.  
Os refletores estão posicionados num nível inferior, evitando assim o deslumbramento.

OUTDOOR

- ① Cuerpo de metal para una mayor disipación del calor  
Corpo de metal para uma maior dissipação do calor
- ② LED hundido para no deslumbrar  
LED afundado para não encadear
- ③ Cerramiento estanco  
Cerramento estanque

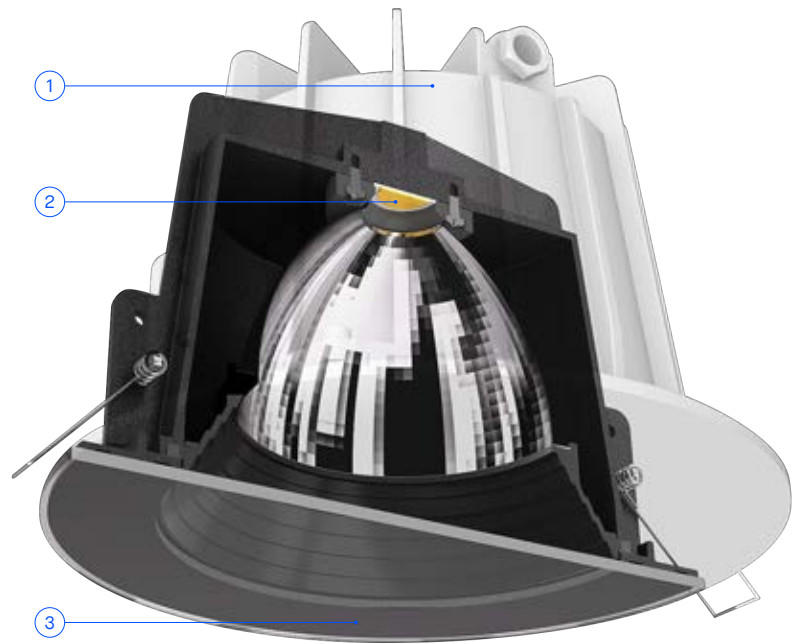

## Accesorio para instalación en techo de hormigón Acessório para instalação em teto de betão



EMPOTRABLES TECHO | ENCASTRÁVEIS DE TETO



# Dako Fixed

BODY MAT	DIF MAT		50000h	3
AL	GLA		L80 B20	MacAdam



## Dako Fixed 80mm

IP	IK	UGR	BREEAM		SEA SIDE SUITABLE		
66	06	<13					

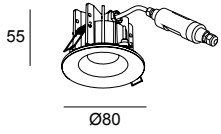

●  
05



LED							
K	CRI	W Total	Real Lm	Optics	Code		
3000	80	7.5	502	29°;40°	15-E035 - 05 - CL	ON-OFF 100-240V	

 68  0-20 mm



## Dako Fixed 175mm

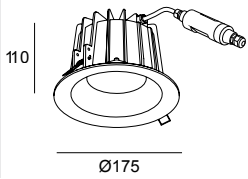

IP	IK	UGR	BREEAM		SEA SIDE SUITABLE		
66	07	<16					

●  
05



LED							
K	CRI	W Total	Real Lm	Optics	Code		
3000	80	20	1821	24°;31°	15-E036 - 05 - CL	ON-OFF 100-240V	

 155  0-17 mm

	Dako Fixed 80mm	Dako Fixed 175mm
		

**Drivers** P. 1166  
**Driver**

	IP67 Driver & Connector IP67 Driver & Connector	Included	Included
-----------------------------------------------------------------------------------	----------------------------------------------------	----------	----------

**Accesorios ópticos**  
**Accesórios óticos**

	Filtro difusor Filtro difusor	Included	Included
-----------------------------------------------------------------------------------	----------------------------------	----------	----------

	Set de 2 reflectores (24° y 31°) Set de 2 refletores (24° e 31°)	-	Included
-----------------------------------------------------------------------------------	---------------------------------------------------------------------	---	----------

	Set de 2 reflectores (29° y 40°) Set de 2 refletores (29° e 40°)	Included	-
-----------------------------------------------------------------------------------	---------------------------------------------------------------------	----------	---

**Accesorios de fijación**  
**Accesórios de fixação**

	Caja de empotrar Caixa de encastrar	-	<b>71-E036-00-00</b>
-------------------------------------------------------------------------------------	----------------------------------------	---	----------------------

# Dako Adjustable

BODY MAT	DIF MAT		50000h	3
AL	GLA		L80 B20	MacAdam



## Dako Adjustable 100mm

IP	IK	UGR	BREEAM		SEA SIDE SUITABLE			
66	06	<13				±20°		

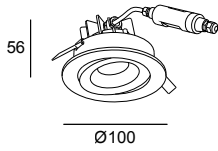
●  
05



LED							
K	CRI	W Total	Real Lm	Optics	Code		
3000	80	7.5	502	29°;40°	15-E104 - 05 - CL	ON-OFF 100-240V	

 80  0-20 mm



## Dako Adjustable 200mm

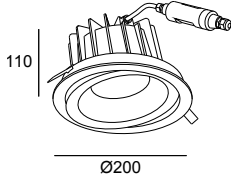
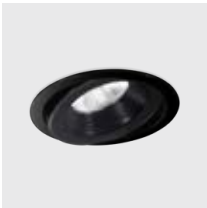

IP	IK	UGR	BREEAM		SEA SIDE SUITABLE			
66	07	<16				±20°		

●  
05



LED							
K	CRI	W Total	Real Lm	Optics	Code		
3000	80	20	1821	24°;31°	15-E105 - 05 - CL	ON-OFF 100-240V	

 180  0-20 mm

	Dako Adjustable 100mm	Dako Adjustable 200mm
		

**Drivers** P. 1166  
**Driver**

	IP67 Driver & Connector IP67 Driver & Connector	Included	Included
-----------------------------------------------------------------------------------	----------------------------------------------------	----------	----------

**Accesorios ópticos**  
**Acessórios óticos**

	Filtro difusor Filtro difusor	Included	Included
-----------------------------------------------------------------------------------	----------------------------------	----------	----------

	Set de 2 reflectores (24° y 31°) Set de 2 refletores (24° e 31°)	-	Included
-----------------------------------------------------------------------------------	---------------------------------------------------------------------	---	----------

	Set de 2 reflectores (29° y 40°) Set de 2 refletores (29° e 40°)	Included	-
-----------------------------------------------------------------------------------	---------------------------------------------------------------------	----------	---

**Accesorios de fijación**  
**Acessórios de fixação**

	Caja de empotrar Caixa de encastrar	71-E104-00-00	71-E105-00-00
-------------------------------------------------------------------------------------	----------------------------------------	---------------	---------------

	Pinzas para fijación a pared Pinças para fixação à parede	Included	Included
-------------------------------------------------------------------------------------	--------------------------------------------------------------	----------	----------

# Gea LED



## Gea LED Downlight

50000h
L80 B20

3
MacAdam

BODY MAT
AlSi316

DIF MAT
GLA



### Downlight LED basculante Downlight LED basculante

Gea LED es una colección de downlights con fuente de luz basculante, diseñada con un marco de acero inoxidable AISI316 y recomendada para ambientes con atmósfera marina.

Gea LED é uma coleção de downlights com uma fonte de luz basculante, concebida com um aro de aço inoxidável AISI316 e recomendada para ambientes com atmosfera marinha.

IP	IK	UGR	BREEAM	SEA SIDE	SUITABLE	±15°	LED	DRIVER
66	10	<19						

CA

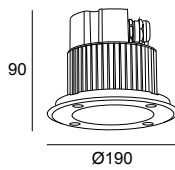

170 12-30 mm

LED							
K	CRI	W Total	Real Lm	Optics	Code		
3000	80	22	1820	40°	15-9948 - CA - CL	ON-OFF 100-240V	
4000	80	22	1915	40°	15-9948 - CA - CM	ON-OFF 100-240V	

# Gea GU10



OUTDOOR

## Gea GU10 Downlight

BODY MAT
AISI316

DIF MAT
GLA



### Downlight con bombilla Downlight com lâmpada

Gea GU10 es una colección de downlights que incluye portalámparas GU10 y GU5.3, diseñada con acero inoxidable AISI316 y recomendada para ambientes con atmósfera marina.

Gea GU10 é uma coleção de downlights que inclui suportes de lâmpadas GU10 e GU5.3, concebida com aço inoxidável AISI316 e recomendada para ambientes com atmosfera marinha.

IP
65

IK
08



SEA SIDE SUITABLE
----------------------

CA

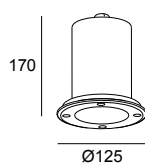
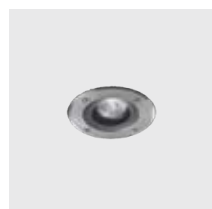

GU10

**W**  
Max. 8

**Code**

**15-9708 - CA - 37**

112 0-40 mm

EMPOTRABLES TETO | ENCASTRÁVEIS DE TETO

### Accesorios ópticos Acessórios óticos



Portalámparas GU5.3  
Casquilho GU5.3

Included

# Empotrables de pared

## Encastráveis de parede

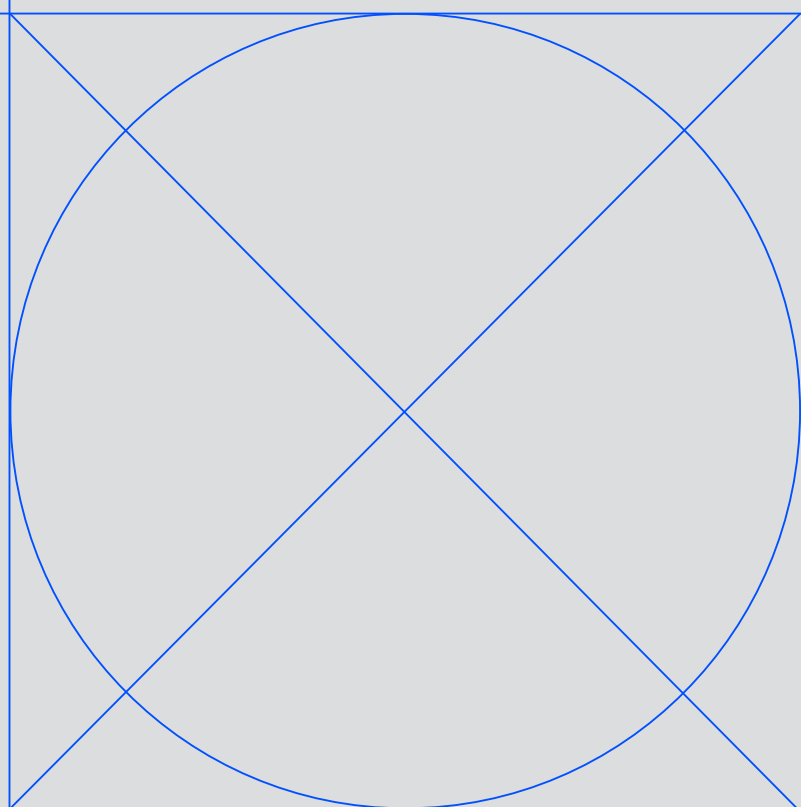



Click

756

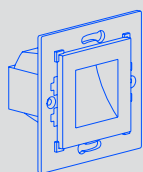

Micenas

758



Bat

760



Tiny

768

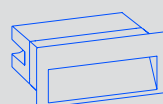

Gea

770

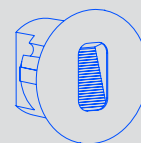

# Click

Designed by LedsC4 Architectural



+ Click



## Diseño limpio y compacto Design limpo e compacto

La colección Click es muy práctica, ya que se ha diseñado para que su instalación sea compatible con las cajas de mecanismos universales. El driver está incluido dentro de la luminaria, lo que facilita aún más la instalación. A coleção Click é muito prática, já que se foi concebida para que a sua instalação seja compatível com as caixas de mecanismos universais. O driver está incluído dentro da luminária, o que facilita ainda mais a instalação.

Perfecto para instalaciones tanto  
exteriores como interiores.  
Perfeito para instalações tanto  
exteriores como interiores.



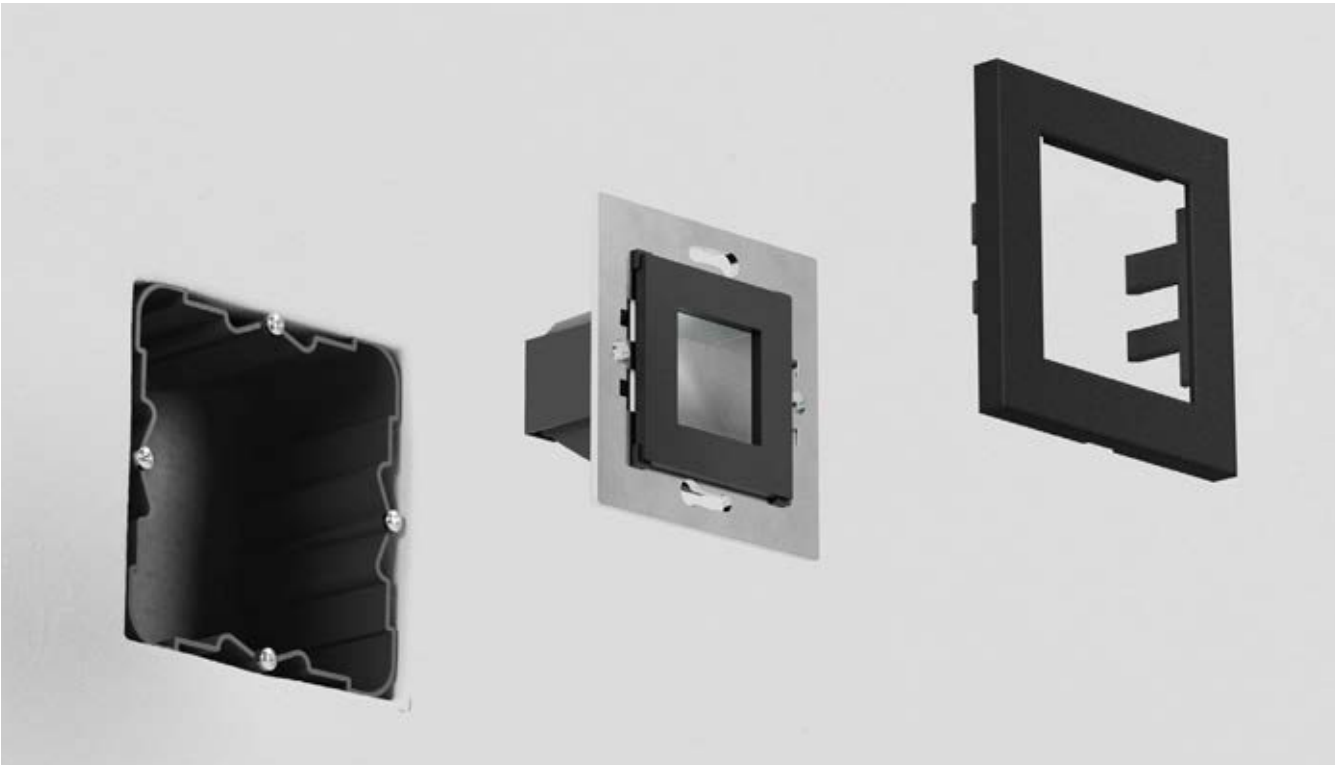

Instalación en cajas de mecanismos universales  
 Instalação em caixas de mecanismos universais

Compatible con todas las cajas de mecanismos universales: cuadradas y redondas, de exterior y de interior, de obra y de pladur.  
 Compatível com todas as caixas de mecanismos universais: quadradas e redondas, de exterior e de interior, de obra e de pladur.

# Click

BODY MAT PC	DIF MAT GLA		50000h L80 B20	IP 65	IK 07	 0 m	SEA SIDE SUITABLE	
----------------	----------------	--	-------------------	----------	----------	---------	----------------------	--

05

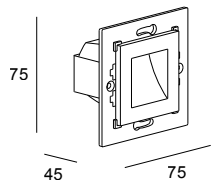

LED						
K	CRI	W Total	Real Lm	Code		
2700	80	1.4	31	<b>05-E141 - 05 - CK</b>	ON-OFF 220-240V	
3000	80	1.4	31	<b>05-E141 - 05 - CL</b>	ON-OFF 220-240V	

## Accesorios de fijación Acessórios de fixação



Frontal  
 Frontal

25 ●	<b>71-E489-25-25</b>
J6 ●	<b>71-E489-J6-J6</b>
14 ○	<b>71-E489-14-14</b>
60 ●	<b>71-E489-60-60</b>
34 ●	<b>71-E489-34-34</b>

# Micenas



+ Micenas



Versátil y adaptable a todos los espacios  
Versátil e adaptável a todos os espaços

Micenas es una colección muy completa y versátil, con variedad de acabados y temperaturas de color. Se adapta iluminando con precisión, tanto espacios compactos como grandes áreas, gracias a los distintos modelos disponibles, con efectos de luz concretos que se adecúan a cada necesidad.

Micenas é uma coleção muito completa e versátil, com variedade de acabamentos e temperaturas de cor. Adapta-se iluminando com precisão, tanto espaços compactos como grandes áreas, graças aos diferentes modelos disponíveis, com efeitos de luz concretos que se adequam a cada necessidade.

**Luz simétrica**  
Luz simétrica

**Luz asimétrica**  
Luz assimétrica

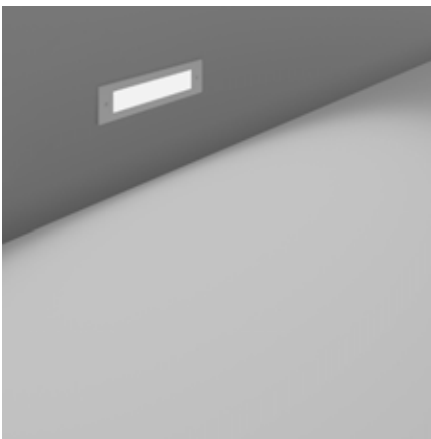

Micenas Symmetrical

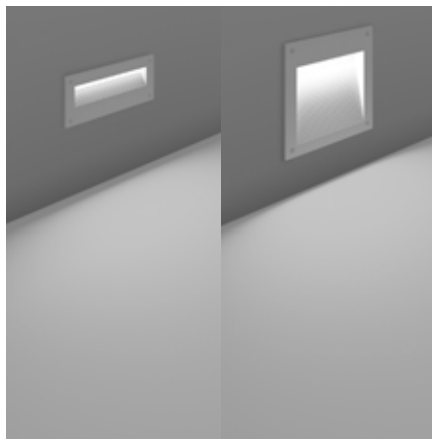

Micenas Asymmetrical



## Micenas Symmetrical

BODY MAT
AL

DIF MAT
GLA



50000h
L80 B20

3
MacAdam

IP
66

IK
O4



Z5 14\* 60\* 34\* J6\* E3\* DL\*

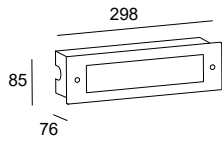
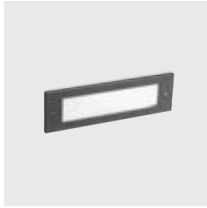

LED

K	CRI	W Total	Real Lm	Optics	Code	
					Z5 J6 E3	
3000	80	10.4	731	112°	05-E051 - DL - CL	ON-OFF 100-277V
					14 60 34	
					Z5 J6 E3	
4000	80	10.4	779	112°	05-E051 - DL - CM	ON-OFF 100-277V
					14 60 34	

## Accesorios de fijación Acessórios de fixação



Caja de empotrar  
Caixa de encastrar

Included

## Micenas Asymmetrical Rectangular

BODY MAT
AL

DIF MAT
GLA

IP
66



Z5 34

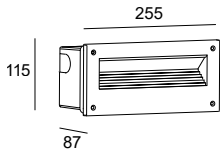

LED

K	CRI	W Total	Real Lm	Optics	Code	
					05-E127 05-E129 05-E135	
SW 2700-3200-4000K	80	6,2	500	105°	- Z5 - 34 - EH	ON-OFF 100-240V

## Micenas Asymmetrical Square

BODY MAT
AL

DIF MAT
GLA

IP
66



Z5 34

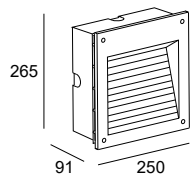

LED

K	CRI	W Total	Real Lm	Optics	Code	
					05-E128 05-E134 05-E136	
SW 2700-3200-4000K	80	27,5	1923	105°	- Z5 - 34 - EH	ON-OFF 220-240V

### Micenas Asymmetrical Rectangular



### Micenas Asymmetrical Square



## Accesorios de fijación Acessórios de fixação



Caja de empotrar  
Caixa de encastrar

Included

Included

# Bat



+ Bat



## La elasticidad de la luz en el mínimo espacio A elasticidade da luz no mínimo espaço

Bat es una propuesta de señalización cuidada al detalle, tanto en el modelado de la luz que emite, como en su estructura, con un cuerpo arenado que embellece aún más la fuga.

Bat é uma proposta de sinalização cuidada ao detalhe, tanto na modelação da luz que emite, como na sua estrutura, com um corpo texturizado com diferentes acabamentos.

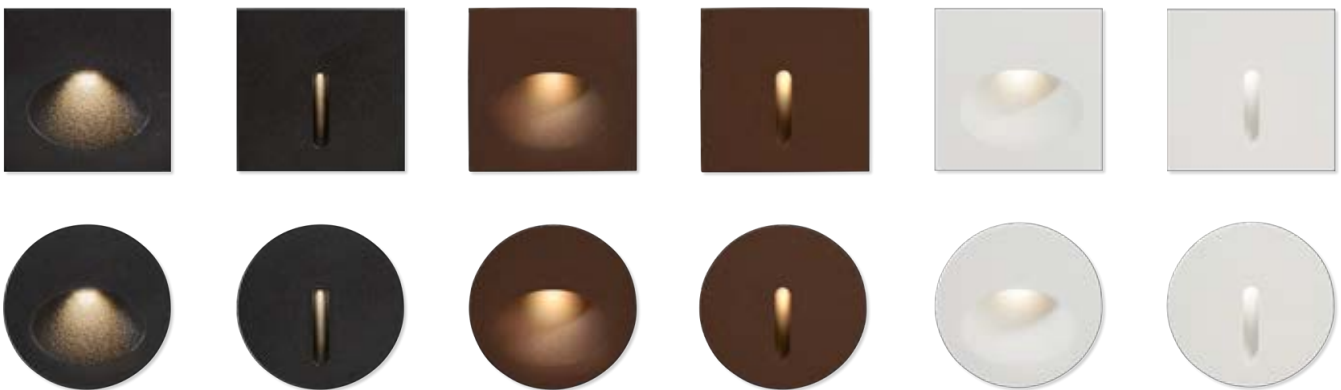



EMPRENDIBLES PAREDES ENCASTRAVEIS DE PAREDE



Distintos efectos para ajustarse a diversas necesidades de señalización.  
 Diferentes efeitos para ajustar-se a diferentes necessidades de sinalização.

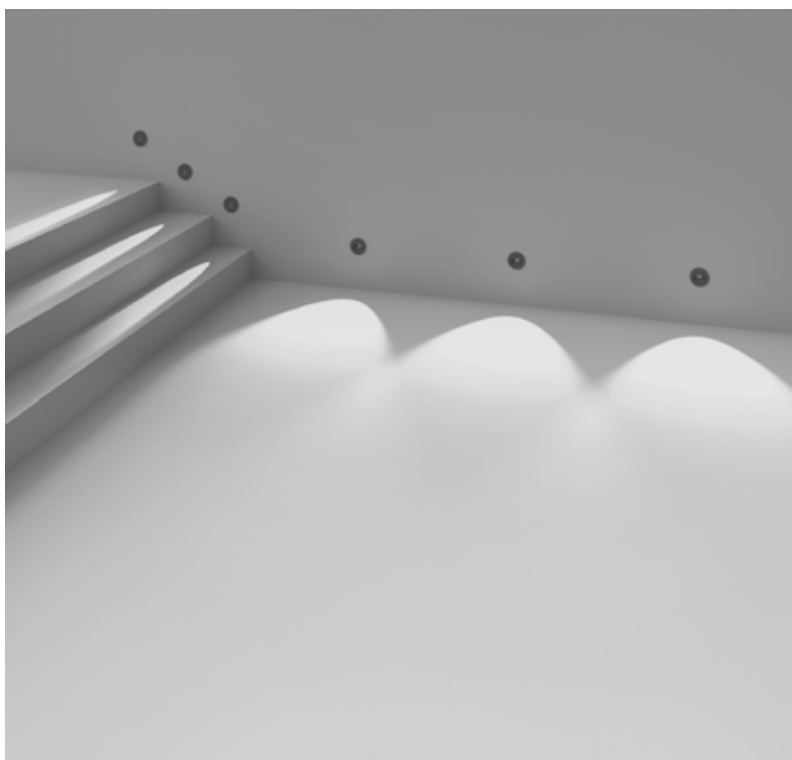

Led con disposición hundida para un máximo confort.  
 LED com disposição afundada para o máximo confort.



Aletas para instalación en pladur y prensaestopa especial antiapertura que garantiza su estanqueidad en espacios exteriores.

Aletas para instalação no pladur e bucim especial antiabertura que garante a sua estanqueidade em espaços exteriores.



Driver integrado  
 Driver integrado

Driver remoto  
 Driver remoto

BODY MAT	DIF MAT	50000h	3
AL	GLA	L80 B20	MacAdam

## Bat Square Lineal

IP	IK	UGR			
66	10	<16		1 m	

● ● ●  
Z5 14 J6

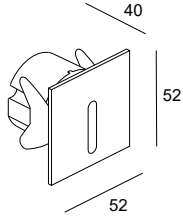

43

LED						max.700mA 3V	
K	CRI	W	Real Lm	Optics	Code		
2700	90	2.2	10	50°	<b>05-E017</b>	<b>Z5</b>	<b>- J6 - CK</b>
						<b>14</b>	
3000	90	2.2	10	50°	<b>05-E017</b>	<b>Z5</b>	<b>- J6 - CL</b>
						<b>14</b>	
4000	90	2.2	10	50°	<b>05-E017</b>	<b>Z5</b>	<b>- J6 - CM</b>
						<b>14</b>	

## Bat Square Lineal Driver

	IP	IK	UGR					
	66	10	<16		1 m			

● ● ●  
Z5 14 J6

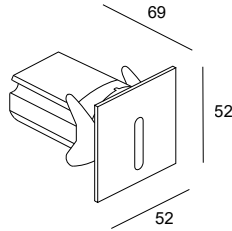

43

LED							
K	CRI	W Total	Real Lm	Optics	Code		
2700	90	3	10	50°	<b>05-E112</b>	<b>Z5</b>	<b>- J6 - CK</b>
						<b>14</b>	
3000	90	3	10	50°	<b>05-E112</b>	<b>Z5</b>	<b>- J6 - CL</b>
						<b>14</b>	
4000	90	3	10	50°	<b>05-E112</b>	<b>Z5</b>	<b>- J6 - CM</b>
						<b>14</b>	

### Bat Square Oval

IP	IK	UGR			
66	10	<16		1 m	

● ○ ●  
Z5 14 J6

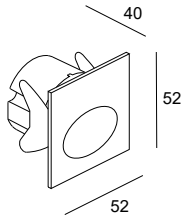
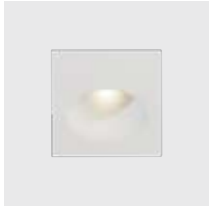

43

LED								
K	CRI	W	Real Lm	Optics	Code			
2700	90	2.2	77	60°	<b>05-E016</b>	<b>Z5</b>	<b>- J6 - CK</b>	<b>14</b>
3000	90	2.2	77	60°	<b>05-E016</b>	<b>Z5</b>	<b>- J6 - CL</b>	<b>14</b>
4000	90	2.2	77	60°	<b>05-E016</b>	<b>Z5</b>	<b>- J6 - CM</b>	<b>14</b>

### Bat Square Oval Driver

	IP	IK	UGR					
	66	10	<16		1 m			

● ○ ●  
Z5 14 J6

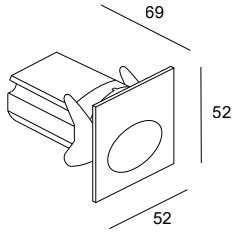
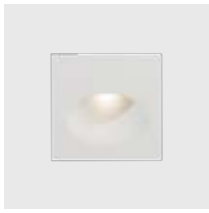

43

LED								
K	CRI	W Total	Real Lm	Optics	Code			
2700	90	3	77	60°	<b>05-E111</b>	<b>Z5</b>	<b>- J6 - CK</b>	<b>14</b>
3000	90	3	77	60°	<b>05-E111</b>	<b>Z5</b>	<b>- J6 - CL</b>	<b>14</b>
4000	90	3	77	60°	<b>05-E111</b>	<b>Z5</b>	<b>- J6 - CM</b>	<b>14</b>

### Bat Round Lineal

IP	IK	UGR			
66	10	<16		1 m	

● ○ ●  
Z5 14 J6

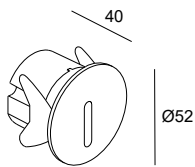

43

LED								
K	CRI	W	Real Lm	Optics	Code			
2700	90	2.2	10	50°	<b>05-E015</b>	<b>Z5</b>	<b>- J6 - CK</b>	<b>14</b>
3000	90	2.2	10	50°	<b>05-E015</b>	<b>Z5</b>	<b>- J6 - CL</b>	<b>14</b>
4000	90	2.2	10	50°	<b>05-E015</b>	<b>Z5</b>	<b>- J6 - CM</b>	<b>14</b>

## Bat Round Lineal Driver

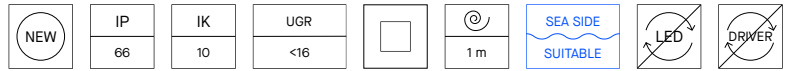

Z5 14 J6

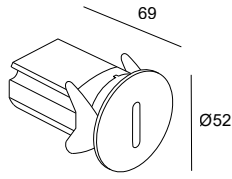

43

LED						
K	CRI	W Total	Real Lm	Optics	Code	
2700	90	3	10	50°	<b>05-E110</b>	Z5 - J6 - CK 14
3000	90	3	10	50°	<b>05-E110</b>	Z5 - J6 - CL 14
4000	90	3	10	50°	<b>05-E110</b>	Z5 - J6 - CM 14

## Bat Round Oval

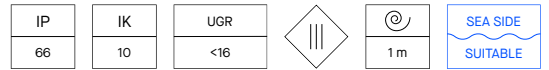

Z5 14 J6

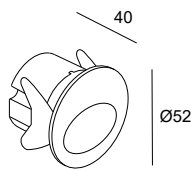

43

LED						
K	CRI	W	Real Lm	Optics	Code	
2700	90	2.2	77	60°	<b>05-E014</b>	Z5 - J6 - CK 14
3000	90	2.2	77	60°	<b>05-E014</b>	Z5 - J6 - CL 14
4000	90	2.2	77	60°	<b>05-E014</b>	Z5 - J6 - CM 14

## Bat Round Oval Driver

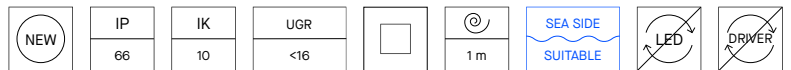



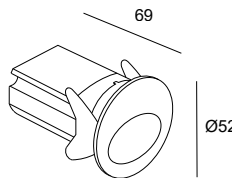

Z5 14 J6







43

LED						
K	CRI	W Total	Real Lm	Optics	Code	
2700	90	3	77	60°	<b>05-E108</b>	Z5 - J6 - CK 14
3000	90	3	77	60°	<b>05-E108</b>	Z5 - J6 - CL 14
4000	90	3	77	60°	<b>05-E108</b>	Z5 - J6 - CM 14

		Bat Square Lineal	Bat Square Lineal Driver	Bat Square Oval	Bat Square Oval Driver
					

## Drivers Driver

P. 1166

	ON-OFF IP20	<b>71-3308-00-00</b> Min.1 - Max.7	-	<b>71-3308-00-00</b> Min.1 - Max.7	<b>71-3308-00-00</b> Min.1 - Max.7
	ON-OFF IP68	<b>71-E014-00-00</b> Min.1 - Max.4	-	<b>71-E014-00-00</b> Min.1 - Max.4	<b>71-E014-00-00</b> Min.1 - Max.4
	DALI2 IP20	<b>71-6192-00-00</b> Min.1 - Max.8	-	<b>71-6192-00-00</b> Min.1 - Max.8	<b>71-6192-00-00</b> Min.1 - Max.8
	DALI2 IP68	<b>71-E080-00-00</b> Min.1 - Max.14	-	<b>71-E080-00-00</b> Min.1 - Max.14	<b>71-E080-00-00</b> Min.1 - Max.14
	Not Dimmable IP20	<b>71-A654-00-00</b> ✎ Min.1 - Max.1	-	<b>71-A654-00-00</b> ✎ Min.1 - Max.1	<b>71-A654-00-00</b> ✎ Min.1 - Max.1

## Controladores Controladores

P. 1166





	DALI IP67	<b>71-A237-00-00</b> ✎ Min.BROADCAST - Max.BROADCAST	-	<b>71-A237-00-00</b> ✎ Min.BROADCAST - Max.BROADCAST	<b>71-A237-00-00</b> ✎ Min.BROADCAST - Max.BROADCAST
-------------------------------------------------------------------------------------	--------------	------------------------------------------------------------	---	------------------------------------------------------------	------------------------------------------------------------

## Accesorios de fijación Acessórios de fixação

	Caja de empotrar Caixa de encastrar	60 ●	<b>71-E065-60-00</b>	<b>71-E065-60-00</b>	<b>71-E065-60-00</b>	<b>71-E065-60-00</b>
		34 ●	<b>71-E404-00-00</b>	<b>71-E404-00-00</b>	<b>71-E404-00-00</b>	<b>71-E404-00-00</b>



## Accesorios de conexión Acessórios de conexão

	Conector anticondensación IP68 (1 entrada + 1 salida) Ø 5,5 - 12mm, 4 polos Conetor anticondensação IP68 (1 entrada + 1 saída) Ø 5,5 - 12 mm, 4 polos	<b>71-E112-00-00</b>	<b>71-E112-00-00</b>	<b>71-E112-00-00</b>	<b>71-E112-00-00</b>
	Conector anticondensación IP68 (1 entrada + 3 salidas) Ø 5,5 - 12mm, 4 polos Conetor anticondensação IP68 (1 entrada + 3 saídas) Ø 5,5 - 12 mm, 4 polos	-	<b>71-E122-00-00</b>	-	<b>71-E122-00-00</b>
	Caja de conexión IP67 (1 entrada + 2 salidas) Ø 6 - 7,5mm, 3 polos Caixa de ligação IP67 (1 entrada + 2 saídas) Ø 6 - 7,5 mm, 3 polos	<b>71-9262-05-05</b>	-	<b>71-9262-05-05</b>	-
	Caja de conexión IP68 (1 entrada + 5 salidas) Ø 6,5 - 11mm, 6 polos Caixa de ligação IP68 (1 entrada + 5 saídas) Ø 6,5 - 11 mm, 6 polos	<b>71-9199-05-05</b>	<b>71-9199-05-05</b>	<b>71-9199-05-05</b>	<b>71-9199-05-05</b>

		Bat Round Lineal	Bat Round Lineal Driver	Bat Round Oval	Bat Round Oval Driver
					

**Drivers**  
Driver

P. 1166

	ON-OFF IP20	<b>71-3308-00-00</b> Min.1 - Max.7	-	<b>71-3308-00-00</b> Min.1 - Max.7	-
	ON-OFF IP68	<b>71-E014-00-00</b> Min.1 - Max.4	-	<b>71-E014-00-00</b> Min.1 - Max.4	-
	DALI2 IP20	<b>71-6192-00-00</b> Min.1 - Max.8	-	<b>71-6192-00-00</b> Min.1 - Max.8	-
	DALI2 IP68	<b>71-E080-00-00</b> Min.1 - Max.14	-	<b>71-E080-00-00</b> Min.1 - Max.14	-
	Not Dimmable IP20	<b>71-A654-00-00</b> ✖ Min.1 - Max.1	-	<b>71-A654-00-00</b> ✖ Min.1 - Max.1	-

**Controladores**  
Controladores

P. 1166

	DALI IP67	<b>71-A237-00-00</b> ✖ Min.BROADCAST - Max.BROADCAST	-	<b>71-A237-00-00</b> ✖ Min.BROADCAST - Max.BROADCAST	-
-------------------------------------------------------------------------------------	--------------	------------------------------------------------------------	---	------------------------------------------------------------	---

**Accesorios de fijación**  
Acessórios de fixação

	Caja de empotrar Caixa de encastrar	60 ●	<b>71-E065-60-00</b>	<b>71-E065-60-00</b>	<b>71-E065-60-00</b>	<b>71-E065-60-00</b>
		34 ●	<b>71-E404-00-00</b>	<b>71-E404-00-00</b>	<b>71-E404-00-00</b>	<b>71-E404-00-00</b>

**Accesorios de conexión**  
Acessórios de conexão

	Conector anticondensación IP68 (1 entrada + 1 salida) Ø 5,5 - 12mm, 4 polos Conetor anticondensação IP68 (1 entrada + 1 saída) Ø 5,5 - 12 mm, 4 polos	<b>71-E112-00-00</b>	<b>71-E112-00-00</b>	<b>71-E112-00-00</b>	<b>71-E112-00-00</b>
	Conector anticondensación IP68 (1 entrada + 3 salidas) Ø 5,5 - 12mm, 4 polos Conetor anticondensação IP68 (1 entrada + 3 saídas) Ø 5,5 - 12 mm, 4 polos	-	<b>71-E122-00-00</b>	-	<b>71-E122-00-00</b>
	Caja de conexión IP67 (1 entrada + 2 salidas) Ø 6 - 7,5mm, 3 polos Caixa de ligação IP67 (1 entrada + 2 saídas) Ø 6 - 7,5 mm, 3 polos	<b>71-9262-05-05</b>	-	<b>71-9262-05-05</b>	-
	Caja de conexión IP68 (1 entrada + 5 salidas) Ø 6,5 - 11mm, 6 polos Caixa de ligação IP68 (1 entrada + 5 saídas) Ø 6,5 - 11 mm, 6 polos	<b>71-9199-05-05</b>	<b>71-9199-05-05</b>	<b>71-9199-05-05</b>	<b>71-9199-05-05</b>

# Tiny



## Confort para iluminación de escaleras Conforto para iluminação de escadas

La proporción compacta de su diseño horizontal y sus prestaciones técnicas, hacen de Tiny una colección ideal para la iluminación de escaleras, ya que se adapta a todo tipo de escalones, así como a toda variedad de zonas de paso.

A proporção compacta do seu design horizontal e as suas prestações técnicas fazem de Tiny uma coleção ideal para a iluminação de escadas, uma vez que se adapta a todo o tipo de degraus e a toda a variedade de zonas de passagem.

### **Pensada para evitar cualquier deslumbramiento**

### **Pensada para evitar qualquer deslumbramento**

El diseño especial de su cabezal permite que el LED quede hundido, lo que garantiza un excelente confort visual en cualquier tipo de instalación.

O design especial da sua cabeça permite que o LED fique afundado, o que garante um excelente conforto visual em qualquer tipo de instalação.

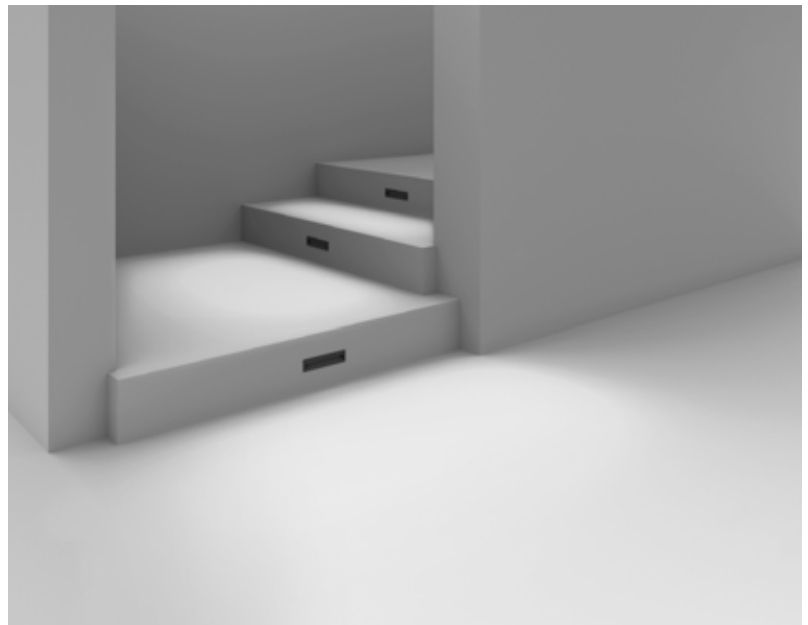



BODY MAT	DIF MAT		50000h	3
AL	GLA		L80 B20	MacAdam

## Tiny Short

IP	IK		SEA SIDE	LED	DRIVER
66	10	2 m	SUITABLE		

●  
Z5

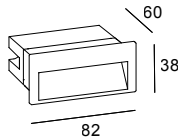
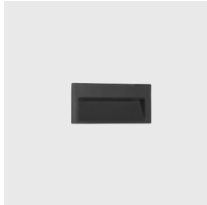

LED						
K	CRI	W Total	Real Lm	Code		
3000	80	2.9	18	<b>05-E146 - Z5 - CL</b>	ON-OFF 220-240V	

## Tiny Large

IP	IK	LOW		SEA SIDE	LED	DRIVER
66	10	FLICKER	2 m	SUITABLE		

●  
Z5

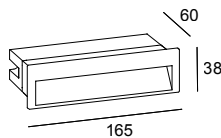
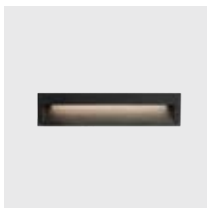

LED						
K	CRI	W Total	Real Lm	Code		
3000	80	7.8	74	<b>05-E147 - Z5 - CL</b>	ON-OFF 220-240V	

### Accesorios de fijación

Accessórios de fixação



Caja de empotrar  
Caixa de encastrar

Included

### Accesorios de conexión

Accessórios de conexão



Conector anticondensación IP68 (1 entrada + 1 salida) Ø 5,5 - 12mm, 4 polos  
Conetor anticondensação IP68 (1 entrada + 1 saída) Ø 5,5 - 12 mm, 4 polos

**71-E112-00-00**



Conector anticondensación IP68 (1 entrada + 3 salidas) Ø 5,5 - 12mm, 4 polos  
Conetor anticondensação IP68 (1 entrada + 3 saídas) Ø 5,5 - 12 mm, 4 polos

**71-E122-00-00**



Caja de conexión IP67 (1 entrada + 2 salidas) Ø 6 - 7,5mm, 3 polos  
Caixa de ligação IP67 (1 entrada + 2 saídas) Ø 6 - 7,5 mm, 3 polos

**71-9262-05-05**



Caja de conexión IP68 (1 entrada + 5 salidas) Ø 6,5 - 11mm, 6 polos  
Caixa de ligação IP68 (1 entrada + 5 saídas) Ø 6,5 - 11 mm, 6 polos

**71-9199-05-05**

# Gea Effect



+ Gea

## Un clásico de acero inoxidable Um clássico de aço inoxidável

Gea LED es una colección de empotrables de pared con fuente de luz LED, diseñada con acero inoxidable AISI316 y recomendada para ambientes con atmósfera marina.  
Gea LED é uma coleção de encastráveis de parede com fonte de luz LED, concebida com aço inoxidável AISI316 e recomendada para ambientes com atmosfera marinha.



## Gea Wall

BODY MAT	DIF MAT		50000h	3
AISI316	GLA		L80 B20	MacAdam

## Solución para bañar fachadas Solução para washlight de fachadas

### Gea Wall Round

IP	IK	SEA SIDE	LED	DRIVER
65	10	SUITABLE		

CA

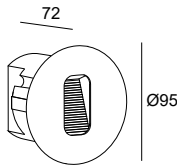

LED

K	CRI	W Total	Real Lm	Optics	Code	
3000	80	3.7	68	55°	05-9757 - CA - CL	ON-OFF 100-240V

80

### Gea Wall Square

IP	IK	SEA SIDE	LED	DRIVER
65	10	SUITABLE		

CA

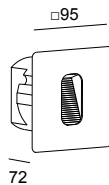

LED

K	CRI	W Total	Real Lm	Optics	Code	
3000	80	3.7	68	55°	05-E031 - CA - CL	ON-OFF 100-240V

80

## Accesorios de fijación Acessórios de fixação



Caja de empotrar  
Caixa de encastrar

Included

BODY MAT AL,CON	DIF MAT GLA		50000h L80 B20	3 MacAdam
--------------------	----------------	--	-------------------	--------------

IP 66	IK 10		SEA SIDE SUITABLE		
----------	----------	--	----------------------	--	--

DC

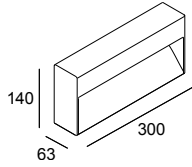

300x140

LED					
K	CRI	W Total	Real Lm	Code	
3000	80	9	404	<b>05-E090 - DC - CL</b>	ON-OFF 230V
4000	80	9	404	<b>05-E090 - DC - CM</b>	ON-OFF 230V

## Accesorios de fijación Acessórios de fixação



Caja de empotrar  
Caixa de encastrar

Z5

71-E090-Z5-00

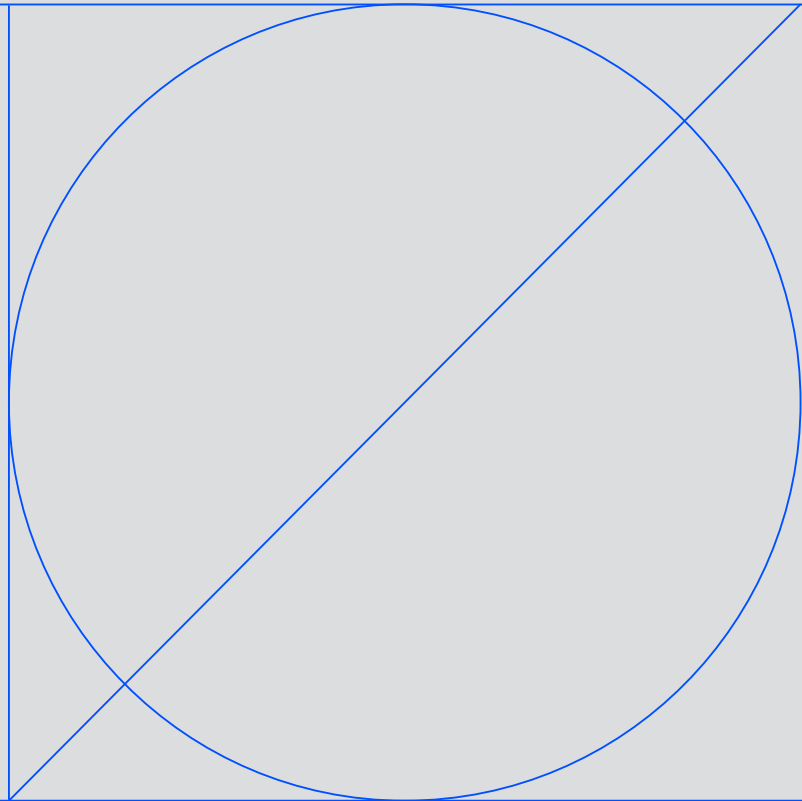

Uplights superficie  
Uplights superficie

Xena

764



Rexel

766

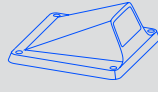

Soul

768



# Xena Surface



## Versátil y de fácil instalación

## Versátil e de instalação fácil

Xena Surface es una colección de fácil instalación ya que no necesita ni empotramiento ni drenajes. Con el driver instalado en el cabezal, no requiere equipo remoto y permite elegir entre dos temperaturas de color, ya que incluye un filtro de 3000K.

Xena Surface é uma coleção de instalação fácil já que não necessita de encastramento nem de drenagens. Com o driver instalado na cabeça, não requer equipamento remoto e permite escolher entre duas temperaturas de cor, já que inclui um filtro de 3000K.

14



34



DL



E3



J6



Z5



60



## Xena Surface 1 Side

	IP 66	IK 10	LOW FLICKER	 800 Kg			
--	----------	----------	----------------	------------	--	--	--

Z5\* 14\* 60\* 34 J6\* E3\* DL\*

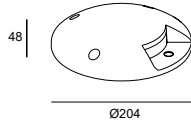

LED						
K	CRI	W Total	Real Lm	Code		
					 <b>Z5</b> <b>J6</b> <b>E3</b>	
4000	80	2	46	<b>55-9945</b>	- DL - CM	ON-OFF 100-240VAC
					<b>14</b> <b>60</b> <b>34</b>	

## Xena Surface 2 Sides

	IP 66	IK 10	LOW FLICKER	 800 Kg			
--	----------	----------	----------------	------------	--	--	--

Z5\* 14\* 60\* 34 J6\* E3\* DL\*

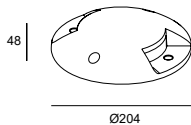

LED						
K	CRI	W Total	Real Lm	Code		
					 <b>Z5</b> <b>J6</b> <b>E3</b>	
4000	80	4.5	78	<b>55-9946</b>	- DL - CM	ON-OFF 100-240VAC
					<b>14</b> <b>60</b> <b>34</b>	

## Xena Surface 4 Sides

	IP 65	IK 10	 800 Kg			
--	----------	----------	------------	--	--	--

Z5\* 14\* 60\* 34 J6\* E3\* DL\*

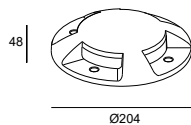

LED						
K	CRI	W Total	Real Lm	Code		
					 <b>Z5</b> <b>J6</b> <b>E3</b>	
4000	80	7.2	163	<b>55-9947</b>	- DL - CM	ON-OFF 100-240V
					<b>14</b> <b>60</b> <b>34</b>	

### Accesorios ópticos

Accessórios óticos



Filtro 3000K  
Filtro 3000K

Included



# Rexel

Designed by Francesc Vilaró

## Compacta y funcional Compacta e funcional

Rexel substituye a los tradicionales proyectores en espacios que requieren de vistas despejadas para dar protagonismo al paisaje o a la arquitectura.

Rexel substitui os projetores tradicionais em espaços que requerem vistas desobstruídas para dar protagonismo à paisagem ou à arquitetura.



Control y ajuste manual  
del cabezal basculante  
para dirigir la luz  
Controlo e ajuste manual  
da cabeça basculante  
para dirigir a luz

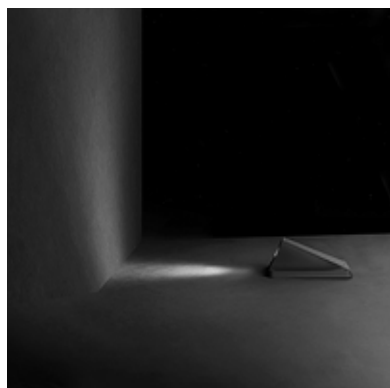

# Rexel

BODY MAT AL	DIF MAT PMMA		50000h L80 B20	3 MacAdam
----------------	-----------------	--	-------------------	--------------

## Rexel 2 LEDS

IP 66	IK 10	LOW FLICKER	BREEAM	SEA SIDE SUITABLE	 0° a 15°		
----------	----------	----------------	--------	----------------------	--------------	--	--

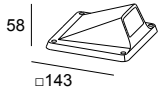

LED							
K	CRI	W Total	Real Lm	Code			
3000	80	3.4	187	<b>55-9883 - Z5 - CL</b>		ON-OFF	100-240VAC
4000	80	3.4	198	<b>55-9883 - Z5 - CM</b>		ON-OFF	100-240VAC

Z5

## Rexel 4 LEDS

IP 66	IK 09	BREEAM	SEA SIDE SUITABLE	 0° a 15°		
----------	----------	--------	----------------------	--------------	--	--

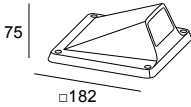

LED							
K	CRI	W Total	Real Lm	Code			
3000	80	6.1	412	<b>55-9741 - Z5 - CL</b>		ON-OFF	100-240V
4000	80	6.1	437	<b>55-9741 - Z5 - CM</b>		ON-OFF	100-240V

Z5

# Soul

Designed by Benedito Design



+ Soul

## Diseño especial que evita empotramiento y drenaje Design especial para evitar encastramento e drenagem

Soul es una luminaria de diseño, con altas prestaciones técnicas y de fácil instalación, ya que, a pesar de ser ultraplana, tiene el equipo incluido en su interior, por lo que no requiere empotramiento ni drenaje. Es una colección versátil con una gran integración arquitectónica. Soul é uma luminária de design, com elevado desempenho técnico e instalação fácil, já que, apesar de ser ultraplana, tem o equipamento incluído no seu interior, pelo que não necessita encastramento nem drenagem. É uma coleção versátil com uma grande integração arquitetónica.



Se puede instalar como plafón en techo  
Pode ser instalada como plafon no teto





# Ópticas Óticas

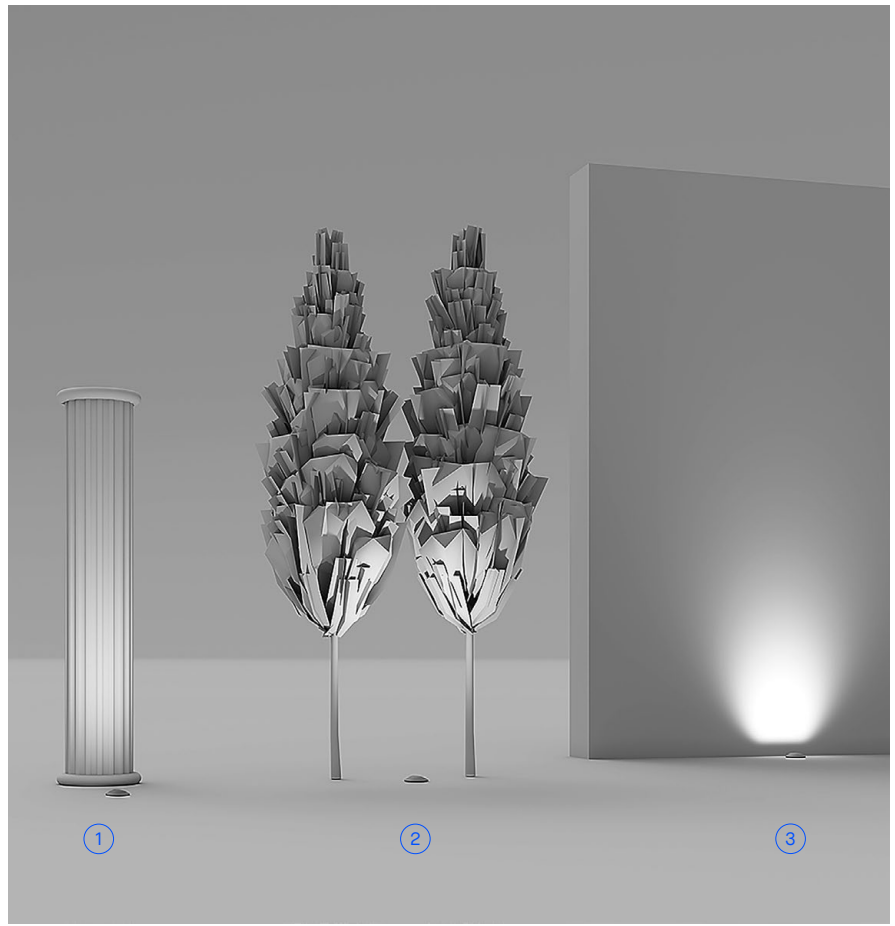

① ②  
Simétricas  
Simétricas

③  
Asimétricas mediante filtro Jumbecker  
Assimétricas mediante filtro Jumbecker

## Soul

BODY MAT	DIF MAT	50000h	3
AL	GLA	L80 B20	MacAdam

### Soul 195mm

IP 66	IK 10	BREEAM	1000 Kg	SEA SIDE SUITABLE	LED
----------	----------	--------	---------	----------------------	-----

Ejemplo de código / Exemplo de código: **AL11-P6V9S2OUZ5**

Model	W	K / Cri / Real lm	Optics	Source	Finishes
<b>AL11 -</b>  	<b>P6</b> 7W	<b>V9</b> 2700K / CRI 90 / 560 lm	<b>S2</b> 16°	<b>OU</b> ON-OFF 100-277V <b>BB</b> 9V/max.700mA	<b>Z5</b>
		<b>W9</b> 3000K / CRI 90 / 638 lm	<b>M3</b> 38°		
		<b>X9</b> 4000K / CRI 90 / 655 lm	<b>F1</b> 48°		

Ejemplo de código / Exemplo de código: **AL12-18V9S20UZ5**

Model	W	K / Cri / Real lm	Optics	Source	Finishes
<b>AL12 -</b> 	<b>18</b> 20W	<b>V9</b> 2700K / CRI 90 / 1680 lm	<b>S2</b> 16°	<b>OU</b> ON-OFF 100-277V	<b>Z5</b> 
		<b>W9</b> 3000K / CRI 90 / 1914 lm	<b>M3</b> 38°	<b>DS</b> DALI-2/PUSH 220-240V	
		<b>X9</b> 4000K / CRI 90 / 1966 lm	<b>F1</b> 48°	<b>XB</b> CASAMBI 220-240V <b>BB</b> 26.5V/ max.700mA	















### Soul 195mm

### Soul 260mm





### Drivers

P. 1166

Driver	Soul 195mm	Soul 260mm
 ON-OFF IP20	<b>71-3542-00-00</b>  Min.1 - Max.8	<b>71-3542-00-00</b>  Min.1 - Max.2
 ON-OFF IP67	-	<b>71-E015-00-00</b>  Min.1 - Max.1
 ON-OFF IP68	<b>71-E014-00-00</b>  Min.1 - Max.1	-
 1-10V DALI2 IP68	-	<b>71-E086-00-00</b>  Min.1 - Max.1
 1-10V DALI2 PUSH IP20	<b>71-4706-00-00</b>  Min.1 - Max.8	<b>71-4706-00-00</b>  Min.1 - Max.2
 DALI2 IP68	<b>71-E080-00-00</b>  Min.1 - Max.4	-

### Controladores

P. 1166

 CASAMBI* IP67	<b>71-A237-00-00</b>  BROADCAST	<b>71-A237-00-00</b>  BROADCAST
------------------------------------------------------------------------------------------------------	-------------------------------------------------------------------------------------------------------------------------	-------------------------------------------------------------------------------------------------------------------------

\*DALI driver required

### Accesorios ópticos

 Difusor wall washer Wall washer diffuser	<b>71-E200-00-00</b>	<b>71-E227-00-00</b>
---------------------------------------------------------------------------------------------------------------------------------	----------------------	----------------------

Balizas / Farolas

Balizas /

Postes de iluminação

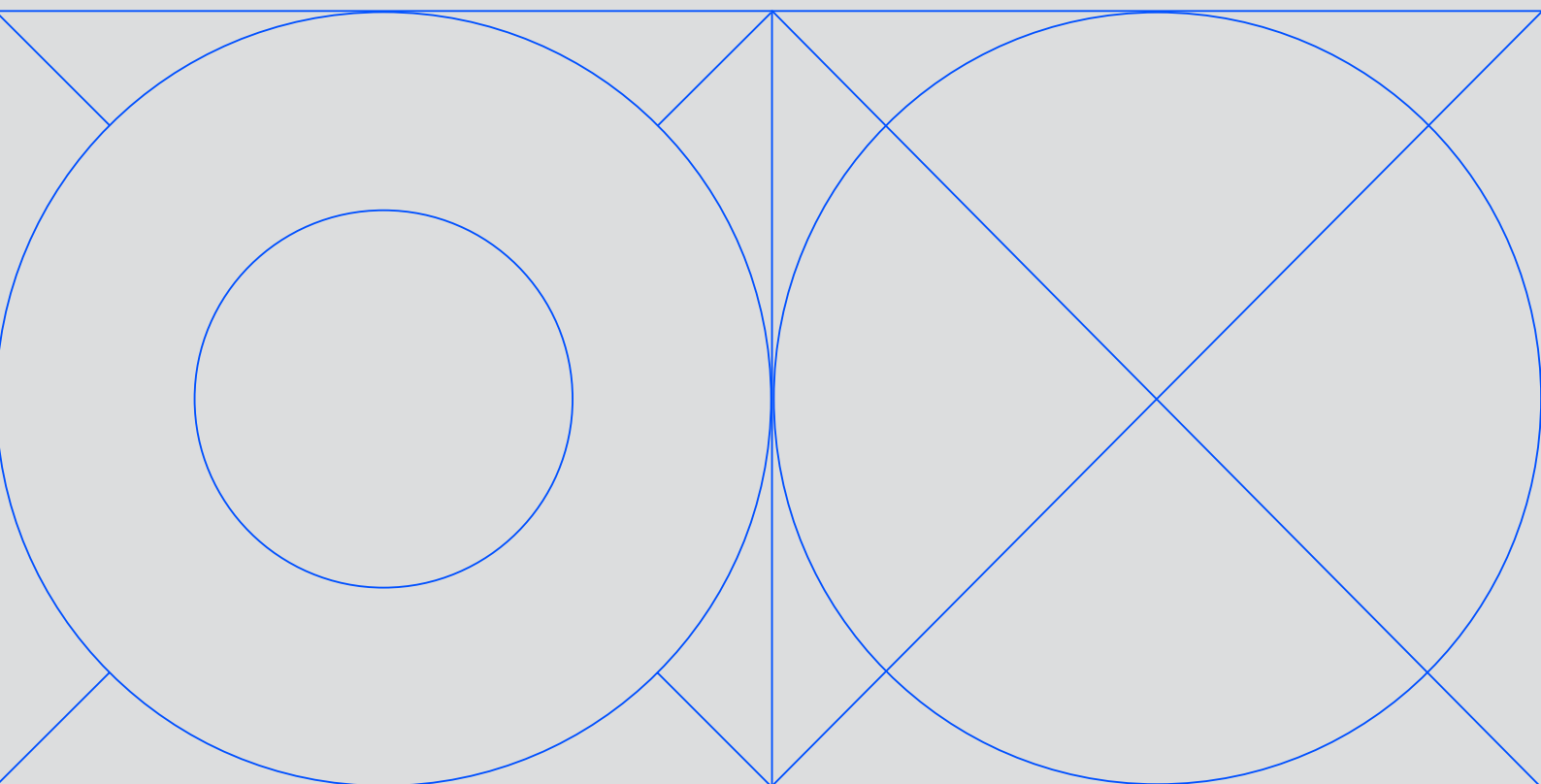



Orbit  
784



Modis  
790



Helion  
796

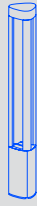

Lyon  
800



Juncus  
802

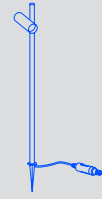

Invisible  
806



Max  
810



Rek  
818



Newton  
824

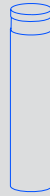

Dan  
830



Row  
834



Simenti  
836

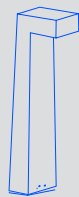

Diago  
837



Cubik  
838



Priap  
842



Nott  
843

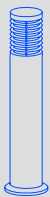

Balizas  
844

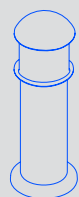

Way  
845



Cubus  
846



Citizen  
847



Proud  
848

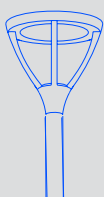

ZigZag  
850



# Orbit

Designed by Luca Turrini



+ Orbit

FAMILIA / FAMÍLIA: Chillout

## Iluminar acompañando Iluminar acompanhando

Orbit es la opción ideal para generar ambientes cálidos en zonas donde la iluminación es la clave del éxito para conectar con clientes y usuarios. De formas suaves y con diversas opciones de acabados y direcciones del haz de luz, la presencia de Orbit confiere un plus de calidad al espacio que habita.

Orbit é a opção ideal para criar ambientes cálidos em zonas onde a iluminação é a chave para o sucesso na ligação com clientes e utilizadores. De formas suaves e diversas opções de acabamentos e direções do feixe de luz, a presença de Orbit confere um plus de qualidade ao espaço onde se insere.



500 mm

900 mm

2300 mm



14

34

DL

E3

J6

Z5

60







Opciones de luz en la parte superior del cabezal:  
Punto de señalización, nula contaminación  
lumínica y suave luz hacia arriba.

Opções de luz na parte superior da cabeça:  
Ponto de sinalização, poluição lumínica nula e  
luz suave para cima.

BODY MAT	DIF MAT		50000h	3
AL	PC		L80 B20	MacAdam

## Orbit Bollard 500mm Covered

	IP	IK	BREEAM	SWITCH CCT			
	66	10		SW 2700-3200-4000			

Z5 14\* 60\* 34\* J6\* E3\* DL\*

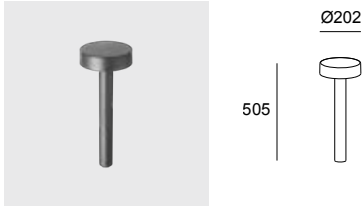

LED							
<b>K</b>	<b>CRI W Total Real LmCode</b>						
SW 2700-3200-4000	80	11.5	761	<b>55-E084</b>	- DL - EH	ON-OFF 100-240V	

El flujo indicado corresponde a la temperatura central.  
O fluxo indicado corresponde à temperatura central.

## Orbit Bollard 500mm Small Hole Cover

	IP	IK	BREEAM	SWITCH CCT			
	66	10		SW 2700-3200-4000			

Z5 14\* 60\* 34\* J6\* E3\* DL\*



LED							
<b>K</b>	<b>CRI W Total Real LmCode</b>						
SW 2700-3200-4000	80	11.5	764	<b>55-E085</b>	- DL - EH	ON-OFF 100-240V	

El flujo indicado corresponde a la temperatura central.  
O fluxo indicado corresponde à temperatura central.

## Orbit Bollard 500mm Big Hole Cover

	IP	IK	BREEAM	SWITCH CCT			
	66	10		SW 2700-3200-4000			

Z5 14\* 60\* 34\* J6\* E3\* DL\*



LED							
<b>K</b>	<b>CRI W Total Real LmCode</b>						
SW 2700-3200-4000	80	11.5	858	<b>55-E086</b>	- DL - EH	ON-OFF 100-240V	

El flujo indicado corresponde a la temperatura central.  
O fluxo indicado corresponde à temperatura central.

\* Consulte condiciones y plazos de entrega a nuestro equipo comercial.  
\* Consultar a nossa equipa comercial para informações sobre as condições e os prazos de entrega.



### Orbit Bollard 900mm Covered

NEW
IP 66
IK 10
BREEAM
SWITCH CCT SW 2700-3200-4000
SEA SIDE SUITABLE
LED
DRIVER

Z5 14\* 60\* 34\* J6\* E3\* DL\*

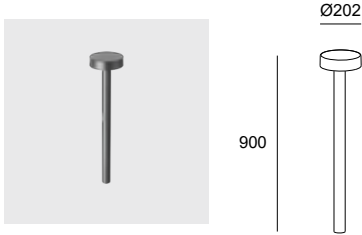

LED							
K	CRI	W	Total	Real	Lm	Code	
SW 2700-3200-4000	80	11.5	761	55-E089	- DL - EH	ON-OFF 100-240V	Z5
							J6
							E3
							14
							60
							34

El flujo indicado corresponde a la temperatura central.  
O fluxo indicado corresponde à temperatura central.

### Orbit Bollard 900mm Small Hole Cover

NEW
IP 66
IK 10
BREEAM
SWITCH CCT SW 2700-3200-4000
SEA SIDE SUITABLE
LED
DRIVER

Z5 14\* 60\* 34\* J6\* E3\* DL\*

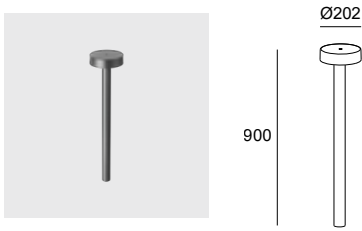

LED							
K	CRI	W	Total	Real	Lm	Code	
SW 2700-3200-4000	80	11.5	764	55-E090	- DL - EH	ON-OFF 100-240V	Z5
							J6
							E3
							14
							60
							34

El flujo indicado corresponde a la temperatura central.  
O fluxo indicado corresponde à temperatura central.

### Orbit Bollard 900mm Big Hole Cover

NEW
IP 66
IK 10
BREEAM
SWITCH CCT SW 2700-3200-4000
SEA SIDE SUITABLE
LED
DRIVER

Z5 14\* 60\* 34\* J6\* E3\* DL\*

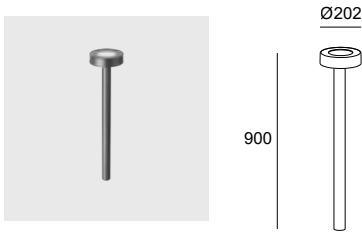

LED							
K	CRI	W	Total	Real	Lm	Code	
SW 2700-3200-4000	80	11.5	858	55-E091	- DL - EH	ON-OFF 100-240V	Z5
							J6
							E3
							14
							60
							34

El flujo indicado corresponde a la temperatura central.  
O fluxo indicado corresponde à temperatura central.

#### Orbit Bollard 500mm

#### Orbit Bollard 900mm



### Accesorios de fijación Acessórios de fixação



Estaca de 302mm  
Estaca de 302 mm

05 71-9998-05-05

71-9998-05-05

BODY MAT	DIF MAT		50000h	3
AL	PC		L80 B20	MacAdam

## Orbit Lamppost 2,3m Covered

	IP	IK	BREEAM	SWITCH CCT			
	66	10		SW 2700-3200-4000			

Z5 14\* 60\* 34\* J6\* E3\* DL\*

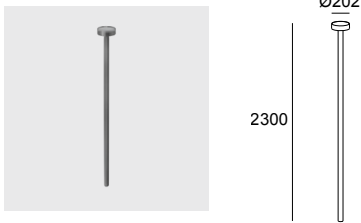

LED		CRI		W		Total		Real		Lm		Code	
<b>K</b>													
SW 2700-3200-4000	80	24	1485	<b>55-E097</b>	- DL	- EH	ON-OFF	100-240V					

El flujo indicado corresponde a la temperatura central.  
O fluxo indicado corresponde à temperatura central.

## Orbit Lamppost 2,3m Small Hole Cover

	IP	IK	BREEAM	SWITCH CCT			
	66	10		SW 2700-3200-4000			

Z5 14\* 60\* 34\* J6\* E3\* DL\*

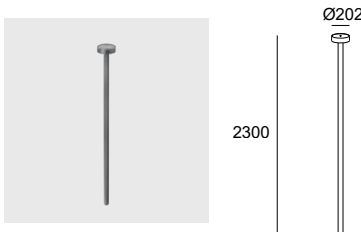

LED		CRI		W		Total		Real		Lm		Code	
<b>K</b>													
SW 2700-3200-4000	80	24	1489	<b>55-E098</b>	- DL	- EH	ON-OFF	100-240V					

El flujo indicado corresponde a la temperatura central.  
O fluxo indicado corresponde à temperatura central.

## Orbit Lamppost 2,3m Big Hole Cover

	IP	IK	UGR	BREEAM	SWITCH CCT			
	66	10	<22		SW 2700-3200-4000			

Z5 14\* 60\* 34\* J6\* E3\* DL\*

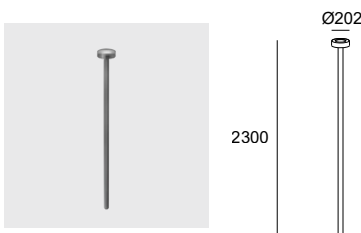

LED		CRI		W		Total		Real		Lm		Code	
<b>K</b>													
SW 2700-3200-4000	80	24	1672	<b>55-E099</b>	- DL	- EH	ON-OFF	100-240V					

El flujo indicado corresponde a la temperatura central.  
O fluxo indicado corresponde à temperatura central.

\* Consulte condiciones y plazos de entrega a nuestro equipo comercial.  
\* Consultar a nossa equipa comercial para informações sobre as condições e os prazos de entrega.



# Modis

Designed by Luca Turrini

FAMILIA / FAMÍLIA: Spotlights, Wall Fixtures, Ceilings

## Libertad de movimientos Liberdade de movimentos

El diseño de doble rótula de Modis permite mover el cabezal de balizas y farolas en cualquier dirección, consiguiendo así una luz confortable, uniforme y direccionada que nos acompaña a lo largo de todo el camino.

O design de dupla junta esférica da Modis permite mover a cabeça das balizas e postes em qualquer direção, proporcionando assim uma luz confortável, uniforme e direcionada que nos acompanha ao longo de todo o caminho.

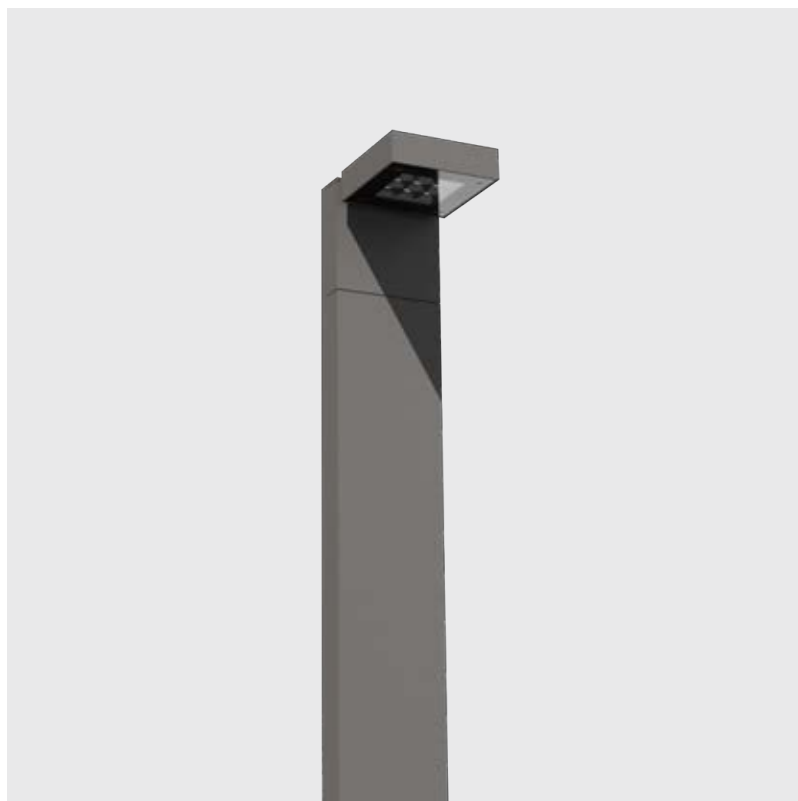

500 mm

1000 mm

2300 mm



14

34

DL

E3

J6

Z5

60





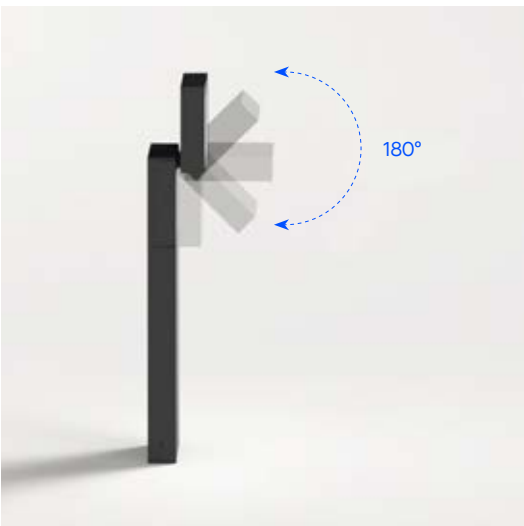

## Modis Bollard Opal 500mm

IP	IK	BREEAM	SWITCH CCT		SEA SIDE SUITABLE				
66	10		SW 2700-3200-4000			90°	350°		

Z5 14\* 60\* 34\* J6\* E3\* DL\*

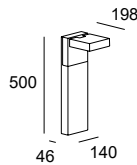

LED	
K	CRI W Total Real LmCode
Z5	
J6	
E3	OU ON-OFF 100-277V
14	DL - DU DALI-2 100-277V
60	XB CASAMBI 220-240V
34	

El flujo indicado corresponde a la temperatura central.  
O fluxo indicado corresponde à temperatura central.

## Modis Bollard Opal 1000mm

IP	IK	BREEAM	SWITCH CCT		SEA SIDE SUITABLE				
66	10		SW 2700-3200-4000			90°	350°		

Z5 14\* 60\* 34\* J6\* E3\* DL\*

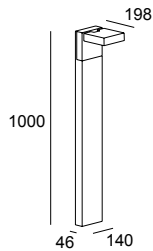

LED	
K	CRI W Total Real LmCode
Z5	
J6	
E3	OU ON-OFF 100-277V
14	DL - DU DALI-2 100-277V
60	XB CASAMBI 220-240V
34	

El flujo indicado corresponde a la temperatura central.  
O fluxo indicado corresponde à temperatura central.

## Modis Bollard Optics 500mm

IP	IK	BREEAM		SEA SIDE SUITABLE				
66	07				350°	180°		

Ejemplo de código / Exemplo de código: **AS14-18V9S30UZ5**

Model	W	K / Cri / Real lm	Optics	Source	Finishes
<b>AS14 -</b> IP66 $\phi$ 350° $\leftarrow$ 180° 	18 20W	<b>V9</b> 2700K / CRI 90 / 1680 lm	<b>S3</b> 16°	<b>OU</b> ON-OFF 100-277V	<b>Z5</b> <b>14*</b> <b>60*</b> <b>34*</b> <b>J6*</b> <b>E3*</b> <b>DL*</b>
		<b>W9</b> 3000K / CRI 90 / 1914 lm	<b>M3</b> 38°	<b>DS</b> DALI-2/PUSH 220-240V	
		<b>X9</b> 4000K / CRI 90 / 1966 lm	<b>F1</b> 48°	<b>XB</b> CASAMBI 220-240V	

\* Consulte condiciones y plazos de entrega a nuestro equipo comercial.  
\* Consultar a nossa equipa comercial para informações sobre as condições e os prazos de entrega.

## Modis Bollard Optics 1000mm



Ejemplo de código / Exemplo de código: **AS15-18V9S3OUZ5**

Model	W	K / Cri / Real lm	Optics	Source	Finishes
<b>AS15 -</b> IP66 $\phi$ 350° $\epsilon$ 180° 	<b>18</b> 20W	<b>V9</b> 2700K / CRI 90 / 1680 lm	<b>S3</b> 16°	<b>OU</b> ON-OFF 100-277V	<b>Z5</b> <b>14*</b> <b>60*</b> <b>34*</b> <b>J6*</b> <b>E3*</b> <b>DL*</b>
		<b>W9</b> 3000K / CRI 90 / 1914 lm	<b>M3</b> 38°	<b>DS</b> DALI-2/PUSH 220-240V	
		<b>X9</b> 4000K / CRI 90 / 1966 lm	<b>F1</b> 48°	<b>XB</b> CASAMBI 220-240V	

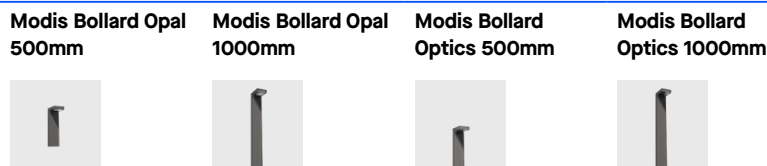

### Accesorios ópticos Acessórios óticos



Visera  
Viseira

	Z5	J6	E3	DL	14	60	34
Modis Bollard Opal 500mm	71-E234-Z5-00	71-E234-J6-00	71-E234-E3-00	71-E234-DL-00	71-E234-14-00	71-E234-60-00	71-E234-34-00
Modis Bollard Opal 1000mm	71-E234-Z5-00	71-E234-J6-00	71-E234-E3-00	71-E234-DL-00	71-E234-14-00	71-E234-60-00	71-E234-34-00
Modis Bollard Optics 500mm	71-E234-Z5-00	71-E234-J6-00	71-E234-E3-00	71-E234-DL-00	71-E234-14-00	71-E234-60-00	71-E234-34-00
Modis Bollard Optics 1000mm	71-E234-Z5-00	71-E234-J6-00	71-E234-E3-00	71-E234-DL-00	71-E234-14-00	71-E234-60-00	71-E234-34-00

### Accesorios de fijación Acessórios de fixação



Pernos de fijación  
Pernos de fixação

Modis Bollard Opal 500mm	71-E363-48-48	71-E363-48-48	71-E363-48-48	71-E363-48-48
--------------------------	---------------	---------------	---------------	---------------

## Modis Lampost Opal 2300mm

IP	IK	BREEAM	SWITCH CCT		SEA SIDE SUITABLE			LED	DRIVER
66	10		SW 2700-3200-4000			350°	90°		

Z5 14\* 60\* 34\* J6\* E3\* DL\*

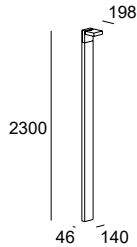

LED	CRI	W	Total Real Lm	Optics	Code
K	80	13.2	744	107°	55-E024
Z5					
J6					
E3					
DL					
14					
60					
34					

El flujo indicado corresponde a la temperatura central.  
O fluxo indicado corresponde à temperatura central.

## Modis Lampost Optics 2300mm

IP	IK	UGR	BREEAM		SEA SIDE SUITABLE			LED	DRIVER
66	07	<10				350°	180°		

Ejemplo de código / Exemplo de código: AS16-18V9S30UZ5

Model	W	K / Cri / Real lm	Optics	Source	Finishes
AS15 -  	18 20W	V9 2700K / CRI 90 / 1680 lm	S3 16°	OU ON-OFF 100-277V	Z5
		W9 3000K / CRI 90 / 1914 lm	M3 38°	DS DALI-2/PUSH 220-240V	14*
		X9 4000K / CRI 90 / 1966 lm	F1 48°	XB CASAMBI 220-240V	60*
					34*
					J6*
					E3*
					DL*

### Modis Lampost Opal 2300mm



### Modis Lampost Optics 2300mm



## Accesorios ópticos Acessórios óticos



Visera  
Viseira

Z5	71-E234-Z5-00	71-E234-Z5-00
J6 *	71-E234-J6-00	71-E234-J6-00
E3 *	71-E234-E3-00	71-E234-E3-00
DL *	71-E234-DL-00	71-E234-DL-00
14 *	71-E234-14-00	71-E234-14-00
60 *	71-E234-60-00	71-E234-60-00
34 *	71-E234-34-00	71-E234-34-00

\* Consulte condiciones y plazos de entrega a nuestro equipo comercial.

\* Consultar a nossa equipa comercial para informações sobre as condições e os prazos de entrega.

# Helion

Designed by LedsC4 Architectural

## Más que iluminación Mais que iluminação

Estilizada y elegante, el diseño parcelado con ventanas de Helion consigue que proyecte un interesante juego de luces y sombras en el suelo, lo que la convierte en una pieza que va más allá de una simple farola o baliza y la convierte en un elemento clave para armonizar el ambiente.

Estilizada e elegante, o design parcelado com janelas de Helion permite projetar um interessante jogo de luz e sombra no chão, tornando-a uma peça que vai para além de um simples poste ou baliza, convertendo-a num elemento chave para harmonizar o ambiente.



800 mm

2300 mm









Luz general y  
decorativa a la vez  
Luz geral e decorativa  
ao mesmo tempo



## Switch CCT



BODY MAT	DIF MAT		50000h	3
AL	PC		L80 B20	MacAdam

## Helion Bollard

IP	IK	BREEAM	SWITCH CCT		SEA SIDE		LED	DRIVER
66	10		SW 2700-3200-4000		SUITABLE	PRO-BASE		

Z5

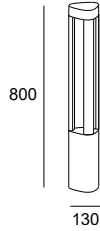

LED		CRI			W	Total	Real	Lm	Code	
K										
SW 2700-3200-4000	80	10.7	701							

El flujo indicado corresponde a la temperatura central.  
O fluxo indicado corresponde à temperatura central.

## Helion Lamppost

IP	IK	BREEAM	SWITCH CCT		SEA SIDE		LED	DRIVER
66	10		SW 2700-3200-4000		SUITABLE	PRO-BASE		

Z5

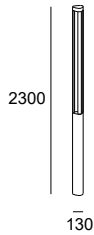

LED		CRI			W	Total	Real	Lm	Code	
K										
SW 2700-3200-4000	80	22	1323							

El flujo indicado corresponde a la temperatura central.  
O fluxo indicado corresponde à temperatura central.

### Helion Bollard



### Helion Lamppost



## Accesorios de fijación Acessórios de fixação



Pernos de fijación  
Pernos de fixação

71-E012-48-48

-

# Lyon

Designed by LedsC4 Architectural



## Flujo lumínico adecuado para alargar los puntos de luz

## Fluxo lumínico adecuado para alongar os pontos de luz

Con un diseño atemporal y prestaciones especialmente desarrolladas para conseguir un buen flujo lumínico, Lyon es la colección perfecta para, utilizando pocos puntos de luz, generar una iluminación general para amplias áreas.

Com um design intemporal e prestações especialmente desenvolvidas para conseguir um bom fluxo lumínico, Lyon é a coleção perfeita para, utilizando poucos pontos de luz, gerar uma iluminação geral para grandes áreas.

## Lyon Bollard

BODY MAT	DIF MAT
AL	PC

IP 66	IK 10		BREEAM	50000h L80 B20	3 MacAdam	SEA SIDE SUITABLE	PRO-BASE	LED	DRIVES
----------	----------	--	--------	-------------------	--------------	----------------------	----------	-----	--------

●  
Z5

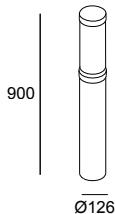

LED						
K	CRI	W Total	Real Lm	Code		
3000	80	26	2146	55-E092 - Z5 - CL	ON-OFF 100-240V	

### Accesorios de fijación Acessórios de fixação



Pernos de fijación  
Pernos de fixação

71-E092-48-48

## Lyon Outdoor LED

IP	IK	UGR		50000h	BREEAM	3	LED	DRIVER
65	10	<16		L80 B20		MacAdam		

Z5 34

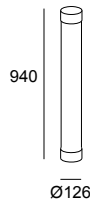

LED							
K	CRI	W Total	Real Lm	Code			
3000	80	59	4580	60-9809 - Z5 - CL		1-10V	100-240V
4000	80	59	5389	60-9809 - Z5 - CM		1-10V	100-240V

## Lyon Outdoor Base 1810mm

Z5 34

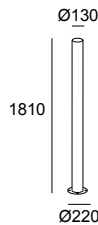

Code	
81-9914	Z5 - Z5 34 - 34

## Lyon Outdoor Base 2310mm

Z5 34

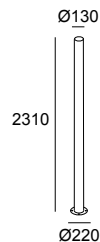

Code	
81-9915	Z5 - Z5 34 - 34

### Accesorios de fijación Acessórios de fixação



Pernos de fijación  
Pernos de fixação

48 71-9957-48-48

### Accesorios de reparación Acessórios de reparação



Pintura Z5 salva-rayadas  
Pintura Z5 contra-riscos

Z5 71-E117-Z5-00

## Iluminación hasta 26 m<sup>2</sup> Iluminação até 26 m<sup>2</sup>

Efecto de luz generado con el cabezal 60-9809 y la columna 81-9914.  
Efeito de luz gerado com a cabeça 60-9809 e a coluna 81-9914.



# Juncus

Designed by Architectural LedsC4



+ Juncus

## Mimetización con el entorno Mimetização com o ambiente

Inspirada en los juncos naturales, esta colección se integra perfectamente con la vegetación y el ambiente. La posibilidad de regular la altura de las balizas, la movilidad de los cabezales y su acabado marrón, permite que se integre completamente en un paisaje natural.

Inspirada em juncos naturais, esta coleção integra-se perfeitamente com a vegetação e o ambiente. A possibilidade de regular a altura das balizas, a mobilidade das cabeças e o seu acabamento castanho permite que se integre completamente numa paisagem natural.

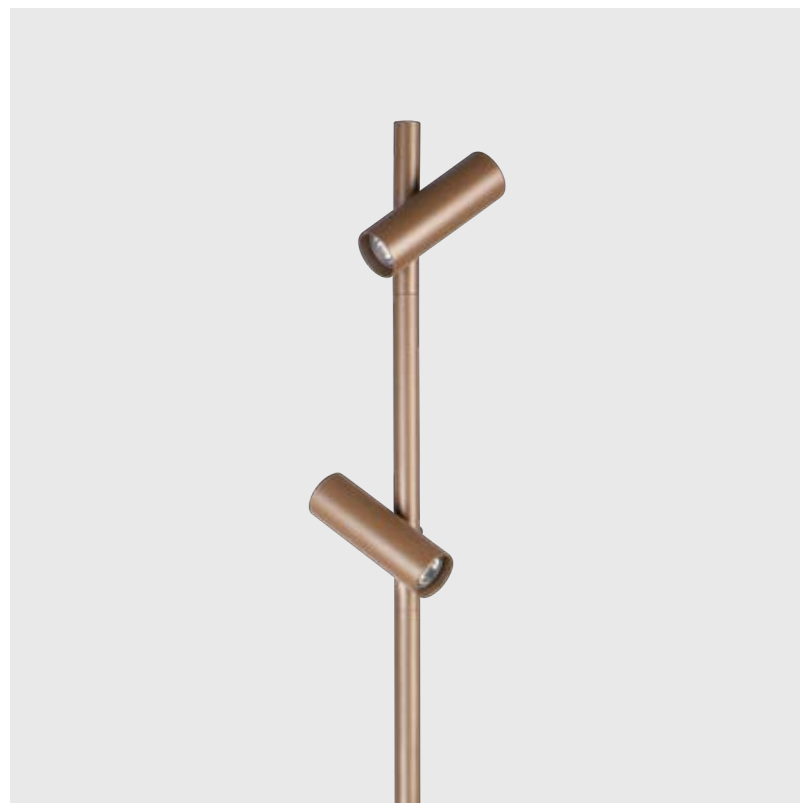

300 mm

700 mm

800 mm

1200 mm

700 mm

1200 mm

3530 mm











## Elección del modo de iluminación Escolha do modo de iluminação

Diseñado para elegir y cambiar fácilmente, sin el uso de herramientas, entre una iluminación con un máximo confort visual o bien con una emisión máxima del haz de luz. Concebido para escolher e mudar facilmente, sem a utilização de ferramentas, entre uma iluminação com um máximo conforto visual ou com uma emissão máxima do feixe de luz.



Modo máximo confort visual (Led hundido)  
Modo máximo de conforto visual (LED afundado)



Modo emisión máxima del haz de luz (Led extendido)  
Modo de emissão máxima do feixe de luz (LED estendido)

## Cabezales con basculación independiente Cabeças com basculação independentes

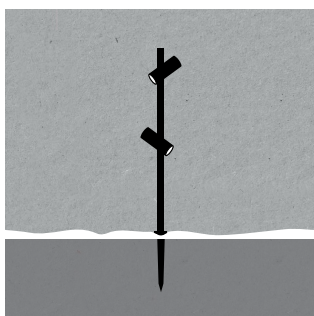
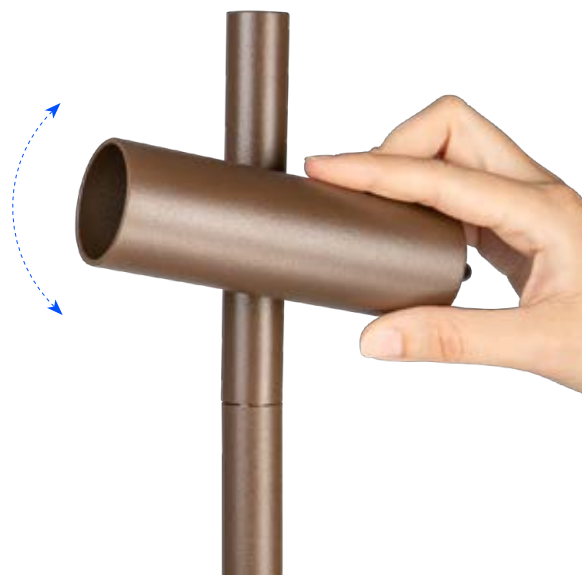

BODY MAT	DIF MAT	50000h	2
AL	GLA	L80 B20	MacAdam

## Juncus 1 Head

IP	IK	LOW		BREEAM		SEA SIDE		LED	DRIVER
65	10	FLICKER			1.5 m	SUITABLE	360°		

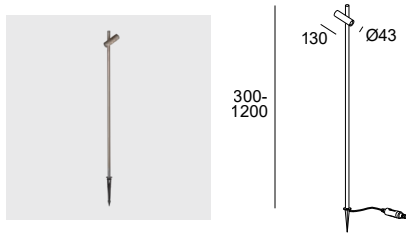

LED						
K	CRI	W Total	Real Lm	Code		
3000	80	8.3	418	10-E013 - J6 - CL	ON-OFF 100-240V	

## Juncus 2 Heads

IP	IK		BREEAM		SEA SIDE		LED	DRIVER
66	10			1 m	SUITABLE	360°		

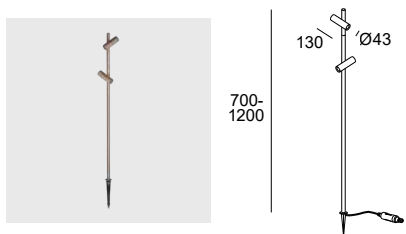

LED						
K	CRI	W Total	Real Lm	Code		
3000	80	15.2	836	10-E018 - J6 - CL	ON-OFF 100-240V	

## Juncus 3 Heads

IP	IK		BREEAM		SEA SIDE		LED	DRIVER
66	05				SUITABLE	±90°		

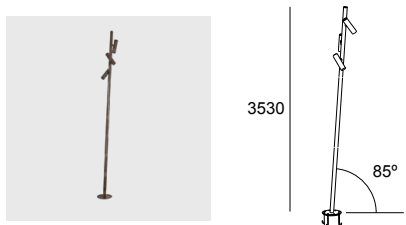

LED						
K	CRI	W Total	Real Lm	Optics	Code	
3000	80	41	3712	45°	60-E057 - J6 - CL	DALI 100-277V

### Juncus 1 Head



### Juncus 2 Heads



### Juncus 3 Heads



## Drivers

P. 1166



IP67 Driver & Connector  
IP67 Driver & Connector

Included

Included

-

## Accesorios de fijación

### Accesórios de fixação



Estaca  
Estaca

Included

Included

-



Pernos y plantilla  
Pernos e aros

-

-

Included

# Invisible

Designed by Francesc Vilaró



+ Invisible



## Minimalismo con un punto de luz flotante Minimalismo com um ponto de luz flutuante

La colección Invisible es un referente por su diseño único y funcional, de líneas simples y puras. Discreta y minimalista, se integra en el espacio creando un punto de luz casi flotante ideal para jardines y terrazas.

A coleção Invisible é uma referência pelo seu design único e funcional, com linhas simples e puras. Discreta e minimalista, integra-se no espaço criando um ponto de luz quase flutuante, ideal para jardins e terraços.







## Luz suave y agradable Luz suave e agradável

Difusor opal para obtener una luz más homogénea y atenuada.

Difusor opal para obter uma luz mais homogénea e atenuada.

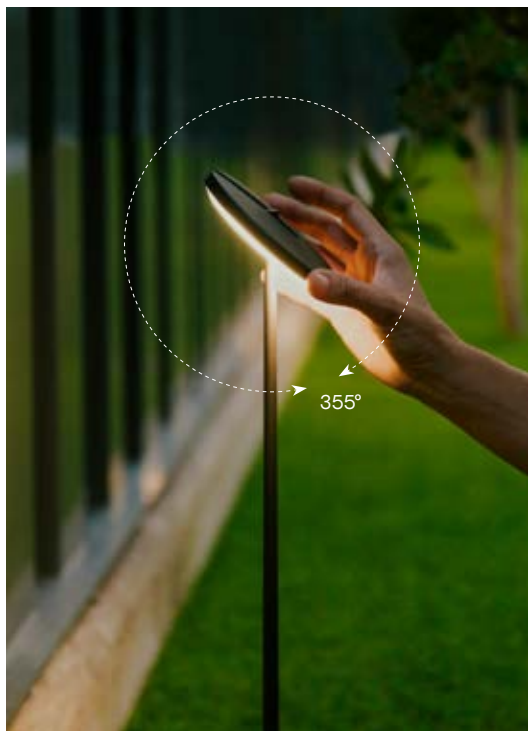

## Cabezal basculante Cabeça basculante

BODY MAT	DIF MAT		50000h	3
AL	PC		L80 B20	MacAdam

## Invisible 600mm

IP	IK	SEA SIDE		LED	DRIVER
54	04	SUITABLE	355°		

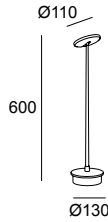

LED					
K	CRI	W Total	Real Lm	Code	
3000	80	10.7	469	<b>55-9733 - 05 - M1</b>	ON-OFF 100-240V

●  
05

## Invisible 2100mm

IP	IK	SEA SIDE		LED	DRIVER
54	04	SUITABLE	355°		

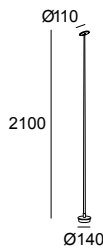

LED					
K	CRI	W Total	Real Lm	Code	
3000	80	10.7	469	<b>25-9733 - 05 - M1</b>	ON-OFF 100-240V

●  
05

## Invisible Adjustable

IP	IK	SEA SIDE		LED	DRIVER
54	04	SUITABLE	355°		



LED					
K	CRI	W Total	Real Lm	Code	
3000	80	10.7	469	<b>10-9733 - 05 - CL</b>	ON-OFF 100-240V

●  
05

### Drivers

P. 1166



IP67 Driver & Connector  
IP67 Driver & Connector

Included

### Accesorios de fijación

Accessórios de fixação



Estaca  
Estaca

Included

# Max

Designed by LedsC4 Architectural



+ Max

**FAMILIA / FAMÍLIA:** Downlights, Uplights, Spotlights, Wall Fixture, Ceiling



## Iluminación paisajística de precisión Iluminação paisagística de precisão

Max baliza ofrece una extensa gama de opciones y accesorios con ángulos de luz muy precisos. Gracias a que su luz residual es mínima y el diseño muy compacto, se convierte en una opción idónea para exteriores selectos y exigentes.

Max baliza oferece uma extensa gama de opções e acessórios com ângulos de luz muito precisos. Uma vez que a sua luz residual é mínima e o design muito compacto, converte-se numa opção ideal para exteriores seletos e exigentes.





## Max Mini

	IP 66	IK 04	 1 m		 360°	
--	----------	----------	---------	--	----------	--

Ejemplo de código / Exemplo de código: **BA17-P2V8S1BBZ5**

Model	W	K / Cri / Real lm	Optics	Source	Finishes		
 <p><b>BA17 -</b> Con Soporte Com suporte IP66</p> 	Constant Current 700mA						
	<b>P2</b> 2.2W	<b>V8</b>	2700K / CRI 80 / 163 lm	<b>S1</b> 10°	<b>BB</b> 3V/max.700mA	<b>Z5</b> <b>14*</b> <b>34*</b> <b>60*</b> <b>DL*</b> <b>E3*</b> <b>J6*</b>	
		<b>W8</b>	3000K / CRI 80 / 185 lm	<b>S2</b> 15°			
		<b>X8</b>	4000K / CRI 80 / 191 lm	<b>M3</b> 32°			
	<b>F2</b> 53°	Constant Voltage 24V					
		<b>P3</b> 2.5W	<b>V8</b>	2700K / CRI 80 / 94 lm	<b>S3</b> 19°		<b>BB</b> 24VDC
<b>W8</b>			3000K / CRI 80 / 97 lm	<b>M3</b> 32°			
<b>X8</b>	4000K / CRI 80 / 87 lm		<b>F2</b> 51°				

## Max Medium

IP 66	IK 10	 1 m		 360°	
----------	----------	---------	--	----------	--

Ejemplo de código / Exemplo de código: **A117-P4V9S1BBZ5**

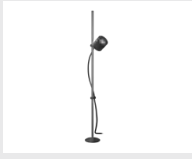
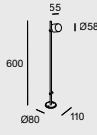
Model	W	K / Cri / Real lm	Optics	Source	Finishes		
 <p><b>A117 -</b> Con Soporte Com suporte IP66</p> 	Constant Current 350mA						
	<b>P4</b> 4W	<b>V9</b>	2700K / CRI 90 / 286 lm	<b>S1</b> 9°	<b>BB</b> 12V/max.350mA	<b>Z5</b> <b>14*</b> <b>34*</b> <b>60*</b> <b>DL*</b> <b>E3*</b> <b>J6*</b>	
		<b>W9</b>	3000K / CRI 90 / 286 lm				
		<b>X9</b>	4000K / CRI 90 / 286 lm				
	<b>P7</b> 6.5W	<b>V9</b>	2700K / CRI 90 / 519 lm	<b>S2</b> 17°	<b>BB</b> 18V/max.350mA		
		<b>W9</b>	3000K / CRI 90 / 459 lm				<b>M2</b> 27°
		<b>X9</b>	4000K / CRI 90 / 423 lm				
	Constant Voltage 24mA						
	<b>P6</b> 6W	<b>V9</b>	2700K / CRI 90 / 204 lm	<b>S1</b> 9°	<b>BB</b> 24VDC		
<b>W9</b>		3000K / CRI 90 / 204 lm					
<b>X9</b>		4000K / CRI 90 / 204 lm					
<b>P8</b> 7.9W	<b>V9</b>	2700K / CRI 90 / 519 lm	<b>S2</b> 17°	<b>BB</b> 24VDC			
	<b>W9</b>	3000K / CRI 90 / 459 lm			<b>M2</b> 27°		
	<b>X9</b>	4000K / CRI 90 / 423 lm				<b>F1</b> 50°	









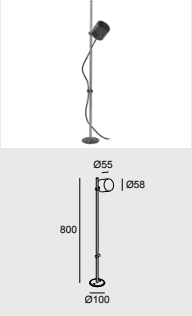

\* Consulte condiciones y plazos de entrega a nuestro equipo comercial.

\* Consultar a nossa equipa comercial para informações sobre as condições e os prazos de entrega.





# Max Big

IP 66	IK 10	1 m	SEA SIDE SUITABLE	360°	LED
----------	----------	-----	----------------------	------	-----

Ejemplo de código / Exemplo de código: **AT17-18V9S3BBZ5**

Model	W	K / Cri / Real lm	Optics	Source	Finishes	
 <p><b>AT17 -</b> Con Soporte Com suporte IP66</p>	Constant Current 500mA					
	<b>18</b> 17.3W	<b>V9</b>	2700K / CRI 90 / 1844 lm	<b>S3</b> 21°	<b>BB</b>  36V/max.500mA	<b>Z5</b>  <b>14*</b>  <b>34*</b>  <b>60*</b>  <b>DL*</b>  <b>E3*</b>  <b>J6*</b> 
		<b>W9</b>	3000K / CRI 90 / 2047 lm	<b>M3</b> 31°		
		<b>X9</b>	4000K / CRI 90 / 1803 lm	<b>F1</b> 40°		
	Constant Voltage 24V					
	<b>14</b> 13.8W	<b>V9</b>	2700K / CRI 90 / 1086 lm	<b>S3</b> 16°	<b>BB</b>  24VDC	
<b>W9</b>		3000K / CRI 90 / 1076 lm	<b>M2</b> 28°			
<b>X9</b>		4000K / CRI 90 / 1120 lm	<b>F2</b> 51°			



\* Consulte condiciones y plazos de entrega a nuestro equipo comercial.  
 \* Consultar a nossa equipa comercial para informações sobre as condições e os prazos de entrega.

	Max Mini Bollard Constant Current	Max Mini Bollard Constant Voltage	Max Medium Bollard Constant Current 4W	Max Medium Bollard Constant Current
				

**Drivers** P. 1166  
Driver

	ON-OFF IP20	<b>71-3308-00-00</b> Min.1 - Max.7	-	<b>71-3542-00-00</b> Min.1 - Max.6	<b>71-3542-00-00</b> Min.1 - Max.4
	ON-OFF IP68	<b>71-E014-00-00</b> Min.1 - Max.4	-	<b>71-E079-00-00</b>  Min.1 - Max.4	<b>71-E079-00-00</b>  Min.1 - Max.2
	1-10V DALI2 IP68	-	-	<b>71-E083-00-00</b> Min.1 - Max.4	<b>71-E083-00-00</b> Min.1 - Max.2
	1-10V DALI2 PUSH IP20	-	-	<b>71-4706-00-00</b> Min.1 - Max.6	<b>71-4706-00-00</b> Min.1 - Max.4
	DALI2 IP20	<b>71-6192-00-00</b> Min.1 - Max.8	-	-	-
	DALI2 IP68	<b>71-E080-00-00</b> Min.1 - Max.14	-	-	-
	CASAMBI IP20	<b>71-A260-00-00</b> Min.4 - Max.15	-	<b>71-A260-00-00</b>  Min.1 - Max.4	<b>71-A260-00-00</b>  Min.1 - Max.2
	Not Dimmable IP20	<b>71-A654-00-00</b>  Min.1 - Max.1	-	-	-

**Fuentes de alimentación** P. 1166  
Fontes de alimentação

	ON-OFF IP67	-	<b>71-E158-00-00</b> Min.1 - Max.9	-	-
	DALI2 IP67	-	<b>71-E098-00-00</b> Min.1 - Max.20	-	-
	Fuente de alimentación estanca con conectores IP67 Fonte de alimentação estanque com conectores IP67	-	<b>71-E101-05-05</b> Min.1 - Max.7	-	-

**Controladores** P. 1166  
Controladores













	CASAMBI IP67	-	<b>71-A242-00-00</b> Min.1 - Max.20	-	-
-------------------------------------------------------------------------------------	-----------------	---	----------------------------------------	---	---

	Max Medium Bollard Constant Voltage PW	Max Medium Bollard Constant Voltage	Max Big Bollard Constant Current	Max Big Bollard Constant Voltage
--	----------------------------------------------	-------------------------------------------	-------------------------------------	-------------------------------------









## Drivers Driver

P. 1166

	ON-OFF IP20	-	-	<b>71-3542-00-00</b>  Min.1 - Max.2	-
	ON-OFF IP68	-	-	<b>71-E079-00-00</b>  Min.1 - Max.1	-
	1-10V DALI2 IP68	-	-	<b>71-E083-00-00</b>  Min.1 - Max.1	-
	1-10V DALI2 PUSH IP20	-	-	<b>71-4706-00-00</b>  Min.1 - Max.2	-
	DALI2 IP20	-	-	-	-
	DALI2 IP68	-	-	-	-
	CASAMBI IP20	-	-	<b>71-A260-00-00</b>  Min.1 - Max.1	-



## Fuentes de alimentación Fontes de alimentação

P. 1166

	ON-OFF IP67	<b>71-E159-00-00</b>  Min.1 - Max.9	<b>71-E159-00-00</b>  Min.1 - Max.7	-	<b>71-6341-00-00</b>  Min.1 - Max.7
	DALI2 IP67	<b>71-E098-00-00</b>  Min.1 - Max.9	<b>71-E098-00-00</b>  Min.1 - Max.7	-	<b>71-E099-00-00</b>  Min.1 - Max.8
	Fuente de alimentación estanca con conectores IP67 Fonte de alimentação estanque com conectores IP67	<b>71-E101-05-05</b>  Min.1 - Max.3	<b>71-E101-05-05</b>  Min.1 - Max.2	-	<b>71-E101-05-05</b>  Min.1 - Max.1

## Controladores Controladores

P. 1166

	CASAMBI IP67	<b>71-A242-00-00</b> Min.4 - Max.15	<b>71-A242-00-00</b> Min.4 - Max.12	-	<b>71-A242-00-00</b>  Min.1 - Max.8
-------------------------------------------------------------------------------------	-----------------	----------------------------------------	----------------------------------------	---	-----------------------------------------------------------------------------------------------------------------------------

Max Mini Bollard  
Constant Current

Max Mini Bollard  
Constant Voltage

Max Medium  
Bollard Constant  
Current P4

Max Medium  
Bollard Constant  
Current



**Accesorios ópticos**  
Acessórios óticos

		71-E422-00-00	71-E422-00-00	71-E131-00-00	71-E131-00-00
Panel de abeja (5u.) Painel de abelha (5u.)					
Difusor cuadrado (5u.) Difusor quadrado (5u.)		71-E421-00-00	71-E421-00-00	71-E135-00-00	71-E135-00-00
Difusor elíptico (5u.) Difusor elíptico (5u.)		71-E420-00-00	71-E420-00-00	71-E141-00-00	71-E141-00-00
Difusor opal (5u.) Difusor opal (5u.)		71-E419-00-00	71-E419-00-00	71-E133-00-00	71-E133-00-00
Difusor wall washer (5u.) Wall washer diffuser (5u.)		71-E462-00-00	71-E462-00-00	71-E463-00-00	71-E463-00-00
Visera Viseira	Z5 ●	71-E417-Z5-00	71-E417-J6-00	71-E145-Z5-Z5	71-E145-Z5-Z5
	J6 ● *	71-E417-J6-00	71-E417-J6-00	71-E145-J6-J6	71-E145-J6-J6
	E3 ● *	71-E417-E3-00	71-E417-J6-00	71-E145-E3-E3	71-E145-E3-E3
	DL ● *	71-E417-DL-00	71-E417-J6-00	71-E145-DL-DL	71-E145-DL-DL
	14 ○ *	71-E417-14-00	71-E417-J6-00	71-E145-14-14	71-E145-14-14
	60 ● *	71-E417-60-00	71-E417-J6-00	71-E145-60-60	71-E145-60-60
	34 ● *	71-E417-34-00	71-E417-J6-00	71-E145-34-34	71-E145-34-34

Max Medium  
Bollard Constant  
Voltage P6



Max Medium  
Bollard Constant  
Voltage



Max Big Bollard  
Constant Current



Max Big Bollard  
Constant Voltage



**Accesorios ópticos**  
Acessórios óticos



Panel de abeja (5u.)  
Painel de abelha (5u.)

71-E131-00-00

71-E131-00-00

71-E263-00-00

71-E263-00-00



Difusor cuadrado (5u.)  
Difusor quadrado (5u.)

71-E135-00-00

71-E135-00-00

71-E262-00-00

71-E262-00-00



Difusor elíptico (5u.)  
Difusor elíptico (5u.)

71-E141-00-00

71-E141-00-00

71-E261-00-00

71-E261-00-00



Difusor opal (5u.)  
Difusor opal (5u.)

71-E133-00-00

71-E133-00-00

71-E260-00-00

71-E260-00-00



Difusor wall washer (5u.)  
Wall washer diffuser (5u.)

71-E463-00-00

71-E463-00-00

71-E464-00-00

71-E464-00-00



Visera  
Viseira

Z5 ●

71-E145-Z5-Z5

71-E145-Z5-Z5

71-E259-Z5-00

71-E259-Z5-00

J6 ● \*

71-E145-J6-J6

71-E145-J6-J6

71-E259-J6-00

71-E259-J6-00

E3 ● \*

71-E145-E3-E3

71-E145-E3-E3

71-E259-E3-00

71-E259-E3-00

DL ● \*

71-E145-DL-DL

71-E145-DL-DL

71-E259-DL-00

71-E259-DL-00

14 ○ \*

71-E145-14-14

71-E145-14-14

71-E259-14-00

71-E259-14-00

60 ● \*

71-E145-60-60

71-E145-60-60

71-E259-60-00

71-E259-60-00

34 ● \*

71-E145-34-34

71-E145-34-34

71-E259-34-00

71-E259-34-00

**Accesorios de fijación**  
Acessórios de fixação



Estaca de 302mm  
Estaca de 302 mm

-

-

71-9998-05-05

71-9998-05-05





Estaca de 235mm  
Estaca de 235 mm

-







-

71-9997-05-05

71-9997-05-05

	<b>Max Mini Constant Current &amp; Constant Voltage</b>	<b>Max Medium Constant Current</b>	<b>Max Big Constant Current</b>
			

**Accesorios de conexión**  
**Accessórios de conexão**

	Conector IP67 (1 entrada + 1 salida) Ø 5,5 - 7,5mm, 3 polos Conetor IP67 (1 entrada + 1 saída) Ø 5,5 - 7,5 mm, 3 polos	<b>71-E510-00-00</b>	<b>71-E510-00-00</b>	<b>71-E510-00-00</b>
	Conector IP67 (1 entrada + 2 salidas) Ø 5,5 - 7,5mm, 3 polos Conetor IP67 (1 entrada + 2 saídas) Ø 5,5 - 7,5 mm, 3 polos	<b>71-E511-00-00</b>	<b>71-E511-00-00</b>	<b>71-E511-00-00</b>
	Conector IP68 (1 entrada + 1 salida) Ø 5,5 - 11,5mm, 4 polos Conetor IP68 (1 entrada + 1 saída) Ø 5,5 - 11,5 mm, 4 polos	<b>71-E512-00-00</b>	<b>71-E512-00-00</b>	<b>71-E512-00-00</b>
	Conector IP68 (1 entrada + 2 salidas) Ø 5,5 - 11,5mm, 3 polos Conetor IP68 (1 entrada + 2 saídas) Ø 5,5 - 11,5 mm, 3 polos	<b>71-E513-00-00</b>	<b>71-E513-00-00</b>	<b>71-E513-00-00</b>
	Conector anticondensación IP68 (1 entrada + 1 salida) Ø 5,5 - 12mm, 4 polos Conetor anticondensação IP68 (1 entrada + 1 saída) Ø 5,5 - 12 mm, 4 polos	<b>71-E112-00-00</b>	<b>71-E112-00-00</b>	<b>71-E112-00-00</b>
	Conector anticondensación IP68 (1 entrada + 3 salidas) Ø 5,5 - 12mm, 4 polos Conetor anticondensação IP68 (1 entrada + 3 saídas) Ø 5,5 - 12 mm, 4 polos	<b>71-E122-00-00</b>	-	<b>71-E122-00-00</b>
	Caja de conexión IP68 (1 entrada + 5 salidas) Ø 6,5 - 11mm, 6 polos Caixa de ligação IP68 (1 entrada + 5 saídas) Ø 6,5 - 11 mm, 6 polos	-	<b>71-9199-05-05</b>	<b>71-9199-05-05</b>



# Rek

Designed by LedsC4 Architectural



+ Rek

## Máxima interdistancia entre balizas

## Máxima interdistância entre balizas

Las prestaciones técnicas de Rek permiten iluminar hasta 40 m<sup>2</sup> utilizando únicamente dos balizas. Con una homogeneidad excelente, esta pieza cumple con los requisitos exigidos por el CTE (Código Técnico de la Edificación): ofrece 20 Lux de media con más del 40% de uniformidad.

As prestações técnicas de Rek permitem uma iluminação de até 40 m<sup>2</sup> utilizando apenas duas balizas. Com excelente homogeneidade, esta peça cumpre os requisitos exigidos pelo CTE (Código Técnico de Edificação): oferece 20 Lux em média com mais de 40% de uniformidade.



180°

360°



14

34

DL

E3

J6

Z5

60





Perfecta para zonas de recorrido  
Perfeita para zonas de passagem

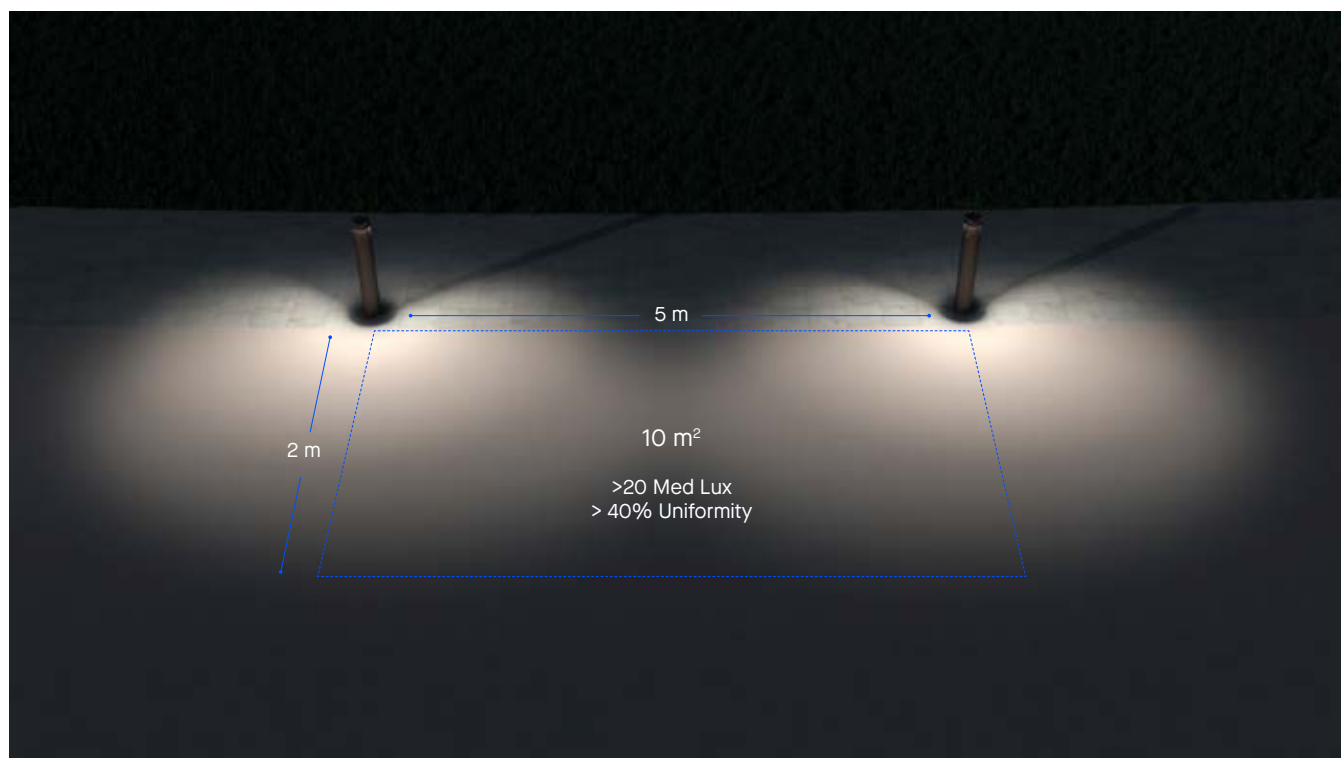

Confort visual y nula  
contaminación lumínica  
Conforto visual e zero  
poluição lumínica



# Disponibile con varios sistemas de regulaci3n Disponível com vários sistemas de regulaç3o

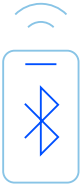

Disponibile en DALI-2 y Bluetooth Casambi.  
Disponível em DALI-2 e Bluetooth Casambi.

## Rek

BODY MAT	DIF MAT		50000h	3
AL	PC		L80 B20	MacAdam

### Rek 533mm 180°

IP	IK	SEA SIDE	PRO-BASE	LED	DRIVER
66	10	SUITABLE			

● ● ● ● ● ● ● ●  
Z5 14\* 60\* 34\* J6\* E3\* DL\*

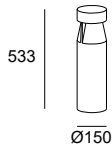

LED											
K	CRI	W Total	Real Lm	Code							
2700	80	13.7	325	55-E025	Z5						
					J6						
					E3	ON-OFF 100-240V					
					55-E026 - DL - CK	DALI-2 220-240V					
					55-E027	CASAMBI 220-240V					
					14						
					60						
					34						
					3000	80	13.7	325	55-E025	Z5	
										J6	
E3	ON-OFF 100-240V										
55-E026 - DL - CL	DALI-2 220-240V										
55-E027	CASAMBI 220-240V										
14											
60											
34											
4000	80	13.7	325	55-E025						Z5	
										J6	
					E3	ON-OFF 100-240V					
					55-E026 - DL - CM	DALI-2 220-240V					
					55-E027	CASAMBI 220-240V					
					14						
					60						
					34						

\* Consulte condiciones y plazos de entrega a nuestro equipo comercial.  
\* Consultar a nossa equipa comercial para informaç3es sobre as condiç3es e os prazos de entrega.

Rek 533mm 360°

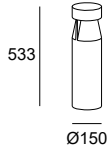

IP	IK
66	10

IK	10
----	----

SEA SIDE  
SUITABLE

PRO-BASE

LED

DRIVER

Z5 14\* 60\* 34\* J6\* E3\* DL\*

LED						
K	CRI	W Total	Real Lm	Code		
2700	80	27	650	55-E028	Z5	
				55-E029	J6	
				55-E030	E3	ON-OFF 100-240V
3000	80	27	650	55-E028	Z5	
				55-E029	J6	
				55-E030	E3	ON-OFF 100-240V
4000	80	27	650	55-E028	Z5	
				55-E029	J6	
				55-E030	E3	ON-OFF 100-240V

Rek 933mm 180°

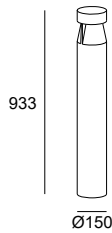

IP	IK
66	10

IK	10
----	----

SEA SIDE  
SUITABLE

PRO-BASE

LED

DRIVER

Z5 14\* 60\* 34\* J6\* E3\* DL\*

LED						
K	CRI	W Total	Real Lm	Code		
2700	80	19.5	459	55-E031	Z5	
				55-E032	J6	
				55-E033	E3	ON-OFF 100-240V
3000	80	19.5	459	55-E031	Z5	
				55-E032	J6	
				55-E033	E3	ON-OFF 100-240V
4000	80	19.5	459	55-E031	Z5	
				55-E032	J6	
				55-E033	E3	ON-OFF 100-240V

\* Consulte condiciones y plazos de entrega a nuestro equipo comercial.  
\* Consultar a nossa equipa comercial para informações sobre as condições e os prazos de entrega.

# Rek 933mm 360°

IP	IK	SEA SIDE	PRO-BASE	LED	DRIVER
66	10	SUITABLE			

Z5 14\* 60\* 34\* J6\* E3\* DL\*

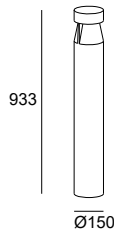

LED						
K	CRI	W Total	Real Lm	Code		
2700	80	40	918	55-E035	Z5	
					J6	
					E3	ON-OFF 100-240V
				55-E036	- DL - CK	DALI-2 220-240V
				55-E037	14	CASAMBI 220-240V
					60	
					34	
3000	80	40	918	55-E035	Z5	
					J6	
					E3	ON-OFF 100-240V
				55-E036	- DL - CL	DALI-2 220-240V
				55-E037	14	CASAMBI 220-240V
					60	
					34	
4000	80	40	918	55-E035	Z5	
					J6	
					E3	ON-OFF 100-240V
				55-E036	- DL - CM	DALI-2 220-240V
				55-E037	14	CASAMBI 220-240V
					60	
					34	

Rek 533mm 180°

Rek 533mm 360°

Rek 933mm 180°

Rek 933mm 360°



## Accesorios de fijación Acessórios de fixação



Pernos de fijación  
Pernos de fixação

71-E092-48-48

71-E092-48-48

71-E092-48-48

71-E092-48-48

\* Consulte condiciones y plazos de entrega a nuestro equipo comercial.

\* Consultar a nossa equipa comercial para informações sobre as condições e os prazos de entrega.

# Newton

Designed by LedsC4 Architectural

## Solución ideal para iluminación de áreas amplias

## Solução ideal para a iluminação de grandes áreas

Las características técnicas de la colección y su estética sobria y atemporal, hacen de Newton una solución ideal para una gran variedad de proyectos. Newton Led Pro resulta especialmente adecuada para la iluminación de grandes espacios exteriores como centros comerciales, universidades, zonas residenciales o resorts gracias a su paquete lumínico con casi 2500 Lm. Sus versiones LED o con bombilla E27 son ideales para espacios más reducidos.

As características técnicas da coleção e a sua estética sóbria e intemporal fazem de Newton a solução ideal para uma grande variedade de projetos. Newton Led Pro é especialmente adequada para a iluminação de grandes espaços exteriores como centros comerciais, universidades, zonas residenciais ou resorts graças ao seu pacote lumínico com quase 2500 Lm. As suas versões LED ou com lâmpada E27 são ideais para espaços mais pequenos.





Newton LED Pro  
826

Newton LED  
828

Newton E27  
829

Ø 250 mm

Ø 250 mm



Ø 700 mm

Ø 800 mm

Ø 800 mm



Ø 1000 mm



28,2 W

12,7 W

max. 23 W



360°



Z5

# Newton

## LED Pro

BODY MAT
AL

DIF MAT
PC, GLA



FAMILIA/FAMÍLIA: Newton LED / Newton E27



Regulable DALI-2 de serie  
Regulável DALI-2 de série



## Newton LED Pro 250mm

IP 66	IK 10	LOW FLICKER	BREEAM		SEA SIDE SUITABLE	PRO-BASE		DRIVER
----------	----------	----------------	--------	--	----------------------	----------	--	--------

Z5



LED						
K	CRI	W Total	Real Lm	Code		
3000	80	25.1	2450	10-E016 - Z5 - CL	DALI 220-240V	

## Newton LED Pro 700mm

IP 66	IK 10	LOW FLICKER	BREEAM		SEA SIDE SUITABLE	PRO-BASE		DRIVER
----------	----------	----------------	--------	--	----------------------	----------	--	--------

Z5

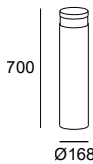

LED						
K	CRI	W Total	Real Lm	Code		
3000	80	25.1	2450	55-E016 - Z5 - CL	DALI 220-240V	

## Newton LED Pro 1000mm

IP 66	IK 10	LOW FLICKER	BREEAM		SEA SIDE SUITABLE	PRO-BASE		DRIVER	(SC)
----------	----------	----------------	--------	--	----------------------	----------	--	--------	------

Z5

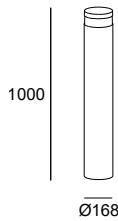

LED						
K	CRI	W Total	Real Lm	Code		
3000	80	25.1	2450	55-E054 - Z5 - CL	DALI 220-240V	

Newton LED Pro 250mm



Newton LED Pro 700mm



Newton LED Pro 1000mm



## Controladores Controladores

P. 1166



DALI

-

-

71-A237-00-00

## Accesorios de fijación Acessórios de fixação



Pernos de fijación  
Pernos de fixação

71-E006-48-48

71-E006-48-48

71-E006-48-48

# Newton LED

BODY MAT
AL

DIF MAT
PC, GLA



## Newton LED 250mm

IP
65

IK
08

50000h
L80 B20

3
MacAdam



●  
Z5

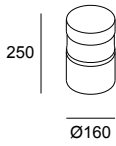
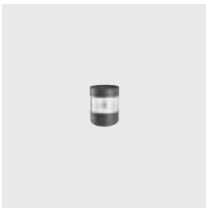

LED

K	CRI	W Total	Real Lm	Code	
3000	80	13.9	573	<b>10-9791 - Z5 - CL</b>	ON-OFF 100-240V

## Newton LED 800mm

IP
65

IK
08

50000h
L80 B20

3
MacAdam



●  
Z5

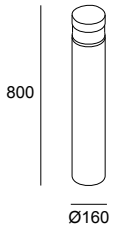

LED

K	CRI	W Total	Real Lm	Code	
3000	80	13.9	573	<b>55-9791 - Z5 - CL</b>	ON-OFF 100-240V

Newton LED 250mm



Newton LED 800mm



## Accesorios de fijación Acessórios de fixação



Pernos de fijación  
Pernos de fixação

71-E013-48-48

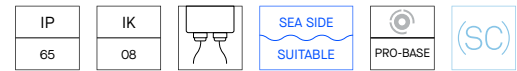

Z5

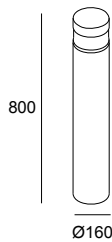

E27

**W**

Max. 15

**Code**

**55-9504 - Z5 - M2**

**Accesorios Smart**  
**Accesórios Smart**



Bombilla E27 RGBW Wifi Light For Life  
 Lâmpada E27 RGBW wi-fi Light For Life

**71-8219-00-00**

**Accesorios de fijación**  
**Accesórios de fixação**



Pernos de fijación  
 Pernos de fixação

**71-E013-48-48**

# Dan

Designed by LedsC4 Architectural



+ Dan

BODY MAT
AL

DIF MAT
PC



3
MacAdam



## Versátil y asequible Versátil e acessível

Dan es un producto básico que se ha desarrollado con especial atención a la calidad de luz y el confort visual. Con una estructura robusta, una alta protección contra impactos, polvo y agua, y un diseño estético, el resultado final es una colección que destaca por su calidez y uniformidad.

Dan é um produto básico que foi desenvolvido com especial atenção à qualidade da luz e ao conforto visual. Com uma estrutura robusta, uma alta proteção contra impactos, poeira e água e um design estético, o resultado final é uma coleção que se destaca pela sua calidez e uniformidade.

Ideal para diferentes ambientes  
Ideal para diferentes ambientes









Accesorio obturador  
de luz incluido  
Acessório obturador  
de luz incluído

Con una única referencia podemos iluminar sólo hacia adelante o en todas direcciones.  
Com uma única referência podemos iluminar apenas para a frente ou em todas as direções.

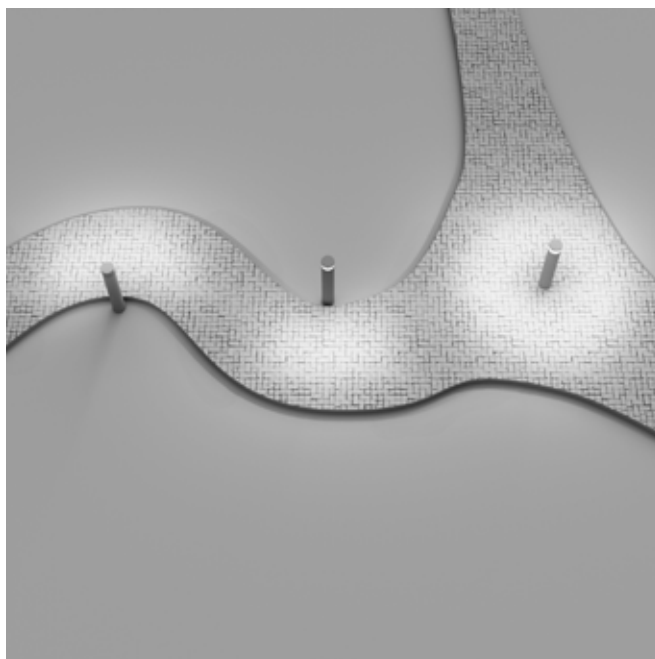

Switch CCT incluido  
Switch CCT incluído

Permite escoger entre 3000K y 4000K.  
Permite escolher entre 3000K e 4000K.

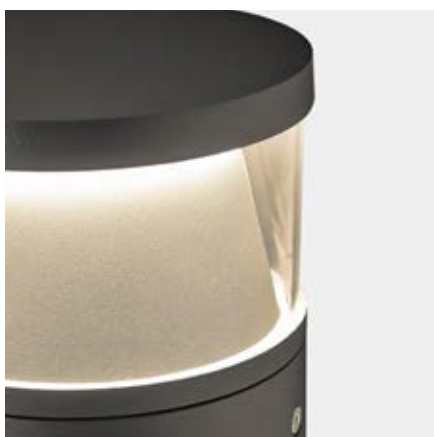

3000 K



4000 K

## Dan 450mm

IP	IK	SWITCH CCT	<a href="#">SEA SIDE</a>			
66	10	SW 3000-4000	<a href="#">SUITABLE</a>	PRO-BASE	LED	DRIVER

Z5 J6

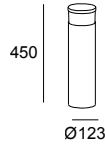

LED						
K	CRI	W Total	Real Lm	Code		
SW 3000-4000	80	1;11.2	439	<b>55-E019</b> - <b>Z5</b> - <b>J6</b> - EH	ON-OFF 100-240V	

## Dan 700mm

IP	IK	SWITCH CCT	<a href="#">SEA SIDE</a>			
66	10	SW 3000-4000	<a href="#">SUITABLE</a>	PRO-BASE	LED	DRIVER

Z5 J6

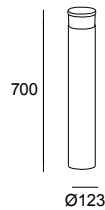

LED						
K	CRI	W Total	Real Lm	Code		
SW 3000-4000	80	1;11.2	439	<b>55-E012</b> - <b>Z5</b> - <b>J6</b> - EH	ON-OFF 100-240V	

### Dan 450mm

### Dan 700mm



### Accesorios ópticos Acessórios óticos



Obturador de luz trasera  
Obturador de luz traseira

Included

Included

### Accesorios de fijación Acessórios de fixação



Pernos de fijación  
Pernos de fixação

71-E092-48-48

71-E092-48-48

# ROW

Designed by LedsC4 Architectural

## Integración en arquitectura de cemento Integração em arquitetura de cimento

Row está realizada 100% en cemento y cuenta con refuerzo metálico en el interior, lo que se traduce en una integración arquitectónica total a la que se le suma la característica de robustez y durabilidad.

Row é realizada 100% em cimento e possui reforço metálico no interior, o que se traduz numa integração arquitetónica total, para além de robustez e durabilidade.



## Row 230mm

IP	IK	BREEAM		SEA SIDE SUITABLE	PRO-BASE		
65	10						

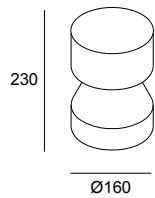

LED						
K	CRI	W Total	Real Lm	Code		
3000	80	19.3	1071	10-E055 - DC - CL	ON-OFF 100-277V	

DC

## Row 500mm

IP	IK	BREEAM		SEA SIDE SUITABLE	PRO-BASE		
65	10						

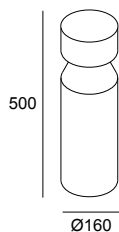

LED						
K	CRI	W Total	Real Lm	Code		
3000	80	19.3	1071	55-E055 - DC - CL	ON-OFF 100-277V	

DC

## Row 900mm

IP	IK	BREEAM		SEA SIDE SUITABLE	PRO-BASE		
65	10						

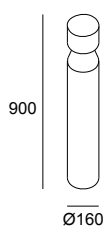

LED						
K	CRI	W Total	Real Lm	Code		
3000	80	19.3	1071	55-E056 - DC - CL	ON-OFF 100-277V	

DC

Row 230mm      Row 500mm      Row 900mm



### Accesorios de fijación Acessórios de fixação

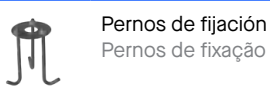

-      71-E029-48-48      71-E029-48-48

# Simeti

Designed by LedsC4 Architectural

FAMILIA / FAMÍLIA: Apliques / Wall Fixture

## Integración y confort visual Integração e conforto visual

La colección Simeti, compuesta por baliza y aplique, está fabricada 100% en cemento y se ha diseñado para ofrecer un alto confort visual, convirtiéndose así en una opción ideal para integraciones en pavimentos de hormigón de residencias de alto standing.  
A coleção Simeti, constituída por baliza e aplique, é fabricada 100% em cimento e foi concebida para oferecer um elevado conforto visual, convertendo-se numa opção ideal para integrações em pavimentos de betão de residências de alto standing.



## Simenti Bollard

BODY MAT	DIF MAT		50000h	3
CON	GLA		L80 B20	MacAdam

IP	IK	LOW	BREEAM	SEA SIDE		
66	08	FLICKER		SUITABLE		

○  
DC

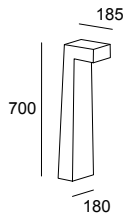

LED						
K	CRI	W Total	Real Lm	Code		
3000	80	11.6	597	<b>55-9971 - DC - CL</b>	ON-OFF 100-240V	

### Accesorios de fijación Acessórios de fixação



Pernos de fijación  
Pernos de fixação

71-E030-48-48

# Diago

FAMILIA / FAMÍLIA: Apliques / Wall Fixture

## Discreta y elegante Discreto e elegante

La baliza Diago tiene un diseño sobrio y compacto; y un efecto de luz contenido y sin contaminación lumínica, lo que la convierten en una buena opción para áreas residenciales.  
A baliza Diago tem um design sóbrio e compacto; e um efeito de luz contido e sem poluição lumínica, tornando-a uma boa opção para áreas residenciais.



## Diago Bollard

BODY MAT	DIF MAT		50000h	3
AL	GLA		L80 B20	MacAdam

IP 65	IK 05	BREEAM	SEA SIDE SUITABLE		
----------	----------	--------	----------------------	--	--

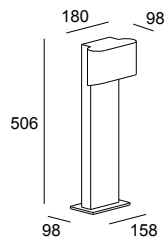

LED					
K	CRI	W Total	Real Lm	Code	
3000	80	6.5	494	<b>55-9873 - Z5 - CL</b>	ON-OFF 100-240V

Z5

### Accesorios de fijación Acessórios de fixação



Pernos de fijación  
Pernos de fixação

71-E009-48-48

# Cubik

Designed by LedsC4 Architectural

## Cubik LED

BODY MAT
AL

DIF MAT
PC



### Elegancia y solidez Elegância e solidez

El clásico diseño rectangular sigue siendo una propuesta ideal para proyectos funcionales de líneas simples y rectas. La amplitud de la colección Cubik permite dar respuesta a todas las necesidades derivadas de este tipo de espacios. O design clássico retangular continua a ser a proposta ideal para projetos funcionais de linhas simples e retas. A amplitude da coleção Cubik torna possível dar resposta a todas as necessidades derivadas deste tipo de espaços.



### Cubik LED 201mm

IP 65	IK 10	BREEAM	50000h L80 B20	3 MacAdam	SEA SIDE SUITABLE	PRO-BASE	LED
----------	----------	--------	-------------------	--------------	----------------------	----------	-----

Z5

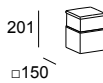

LED							
K	CRI	W Total	Real Lm	Code			
3000	80	16.2	833	10-9938 - Z5 - CL	ON-OFF 100-240V		

### Cubik LED 650mm

IP 65	IK 10	BREEAM	50000h L80 B20	3 MacAdam	SEA SIDE SUITABLE	PRO-BASE	LED	DRIVER
----------	----------	--------	-------------------	--------------	----------------------	----------	-----	--------

Z5

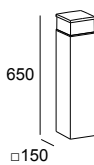

LED							
K	CRI	W Total	Real Lm	Code			
3000	80	16.2	833	55-9938 - Z5 - CL	ON-OFF 100-240V		



**Cubik LED 1000mm**

IP 65	IK 10	BREEAM	50000h L80 B20	3 MacAdam	SEA SIDE SUITABLE	PRO-BASE	LED
----------	----------	--------	-------------------	--------------	----------------------	----------	-----

Z5

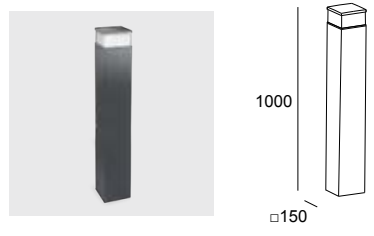

LED						
K	CRI	W Total	Real Lm	Code		
3000	80	16.2	833	<b>55-9939 - Z5 - CL</b>	ON-OFF	100-240V

**Accesorios de fijación**  
**Acessórios de fixação**



Pernos de fijación  
 Pernos de fixação

**71-E164-48-48**

# Cubik

## E27

BODY MAT
AL

DIF MAT
PC



### Elegancia y solidez

### Elegância e solidez

El clásico diseño rectangular sigue siendo una propuesta ideal para proyectos funcionales de líneas simples y rectas. La amplitud de la colección Cubik permite dar respuesta a todas las necesidades derivadas de este tipo de espacios

O design clássico retangular continua a ser a proposta ideal para projetos funcionais de linhas simples e retas. A amplitude da coleção Cubik torna possível dar resposta a todas as necessidades derivadas deste tipo de espaços.



### Cubik E27 230mm

IP
54

IK
10

SEA SIDE
SUITABLE

●  
Z5

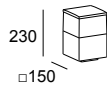

E27
<b>W</b> Max. 15
<b>Code</b> <b>10-9386 - Z5 - M3</b>

### Cubik E27 300mm

IP
54

IK
10

BREEAM
--------

SEA SIDE
SUITABLE

●  
Z5

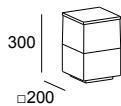

E27
<b>W</b> Max. 15
<b>Code</b> <b>10-9387 - Z5 - M3</b>

**Cubik E27 600mm**

IP	IK	SEA SIDE
54	10	SUITABLE

Z5

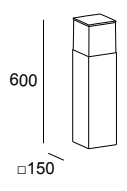

E27	
<b>W</b> Max. 15	<b>Code</b> <b>55-9488 - Z5 - M3</b>

**Cubik E27 900mm**

IP	IK	SEA SIDE
54	10	SUITABLE

Z5

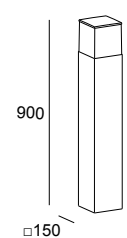

E27	
<b>W</b> Max. 15	<b>Code</b> <b>55-9549 - Z5 - M3</b>

**Accesorios de fijación**  
**Acessórios de fixação**



Pernos de fijación  
Pernos de fixação

**71-E002-48-48**

# Priap

Designed by LedsC4 Architectural

BODY MAT
AISI316

DIF MAT
PC



## Calidad superior Qualidade superior

Fabricada íntegramente en acero inoxidable AISI 316, es apta para instalarse en ambientes con climatología adversa como zonas marinas. Sus reflectores internos permiten minimizar la contaminación lumínica.

Fabricada inteiramente em aço inoxidável AISI 316, é adequada para ser instalada em ambientes com climatologia adversa, como zonas marinhas. Os seus refletores internos permitem minimizar a poluição lumínica.



## Priap 500mm

IP
54

IK
07

SEA SIDE
SUITABLE

PRO-BASE
----------

●  
CA

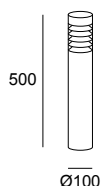

E27

**W**  
Max. 15

**Code**

**55-9239 - CA - M2**

## Priap 800mm

IP
54

IK
07

SEA SIDE
SUITABLE

PRO-BASE
----------

●  
CA

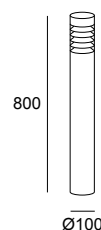

E27

**W**  
Max. 15

**Code**

**55-9440 - CA - M2**

## Accesorios de fijación Acessórios de fixação



Pernos de fijación  
Pernos de fixação

71-E028-48-48

**Resistente a alta humedad constante**  
**Resistente a humedad elevada constante**

Capaz de resistir a las condiciones de humedad y salinidad más extremas gracias a sus materiales plásticos de alta calidad y a su portalámparas E-27, como único componente electrónico.

Capaz de suportar as condições mais extremas de humidade e de salinidade graças aos seus materiais plásticos de alta qualidade e ao seu suporte de lâmpadas E-27, como único componente eletrónico.



## Nott E27 500mm

IP	IK	SEA SIDE SUITABLE
65	08	

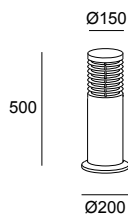
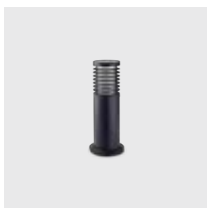

E27	
<b>W</b>	<b>Code</b>
Max. 15	55-9655 - 05 - CD

●  
05

## Nott E27 900mm

IP	IK	SEA SIDE SUITABLE
65	08	

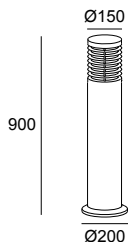

E27	
<b>W</b>	<b>Code</b>
Max. 15	55-9656 - 05 - CD

●  
05

**Accesorios de fijación**  
**Acessórios de fixação**



Pernos de fijación  
Pernos de fixação

71-E018-48-48

# Balizas

BODY MAT
AL

DIF MAT
PC



## Un clásico actualizado Um clássico atualizado

Clásica colección de uso residencial con fuente de luz E-27 y un aspecto robusto suavizado por formas redondeadas. Resistente a ambientes con atmósfera marina.

Clássica coleção de uso residencial com fonte de luz E-27 e um aspeto robusto suavizado por formas arredondadas. Resistente a ambientes com atmosfera marinha.

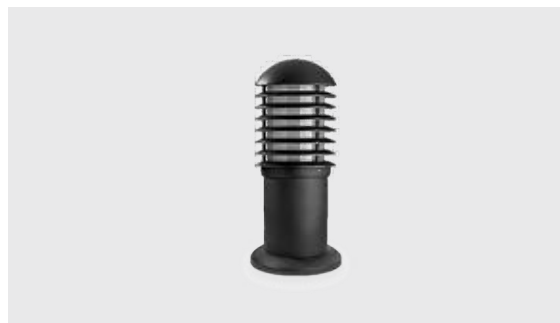

## Balizas Grid 300mm

IP
44

IK
08

SEA SIDE
SUITABLE

●  
Z5

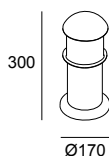
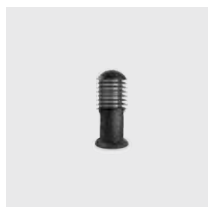

E27

**W**  
Max. 15

**Code**  
55-9318 - Z5 - M3

## Balizas Grid 500mm

IP
44

IK
08

SEA SIDE
SUITABLE

●  
Z5

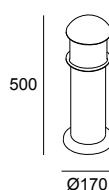
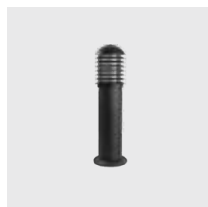

E27

**W**  
Max. 15

**Code**  
55-9319 - Z5 - M3

## Balizas Grid 900mm

IP
44

IK
08

SEA SIDE
SUITABLE

●  
Z5

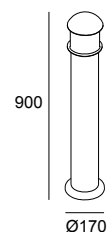
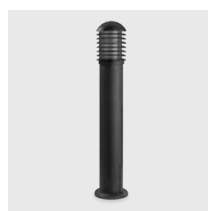

E27

**W**  
Max. 15

**Code**  
55-9320 - Z5 - M3

## Accesorios de fijación Acessórios de fixação



Pernos de fijación  
Pernos de fixação

71-9955-48-48

## Haz de luz dirigible Feixe de luz dirigível

Esta funcional familia, con su cabezal basculante, es especialmente útil en espacios dónde necesitamos direccionar la luz de y resaltar algunas áreas o elementos específicos.

Esta funcional familia, com a sua cabeça basculante, é especialmente útil em espaços onde necessitamos direccionar a luz e destacar algumas áreas ou elementos específicos.



## Way Bollard

### Way 600mm

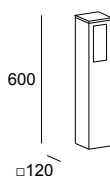

GU10

**W**  
Max. 8

**Code**  
**55-9682 - Z5 - 37**

75

### Way 1000mm

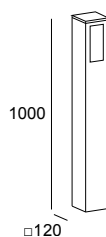

GU10

**W**  
Max. 8

**Code**  
**55-9921 - Z5 - 37**

15

## Accesorios de fijación Acessórios de fixação



Pernos de fijación  
Pernos de fixação

71-E031-48-48



# Cubus

Designed by LedsC4 Architectural

BODY MAT	DIF MAT		50000h	3
AL	GLA		L80 B20	MacAdam

## Doblemente funcional Duplamente funcional

El doble cabezal con rotación independiente de la baliza Cubus es adecuado para iluminar zonas oscuras donde el haz de luz de balizas convencionales no consigue llegar.  
A cabeça dupla com rotação independente da baliza Cubus é adequada para iluminar zonas escuras onde o feixe de luz das balizas convencionais não consegue chegar.



# Cubus

## Bollard

IP	IK	SEA SIDE			
65	10	SUITABLE	±45°		

Z5

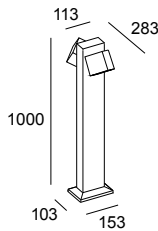

### LED

K	CRI	W Total	Real Lm	Code	
3000	80	24.9	1031	55-9944 - Z5 - CL	ON-OFF 100-240V

## Accesorios de fijación Acessórios de fixação



Pernos de fijación  
Pernos de fixação

71-E008-48-48



## Presencia y robustez Presença e robustez

Sus grandes dimensiones, una potencia destacada y una emisión 360° hacen de esta colección una solución muy adecuada para espacios amplios con grandes edificios. Citizen tiene una gran capacidad de disipación, lo que se traduce en una alta eficiencia energética.

As suas grandes dimensões, uma potência excepcional e uma emissão de 360° fazem desta coleção uma solução muito adequada para amplos espaços com grandes edifícios. Citizen tem uma elevada capacidade de dissipação, o que se traduz numa elevada eficiência energética.



## Citizen LED

IP	IK	UGR		BREEAM	50000h	2	SEA SIDE SUITABLE		
65	10	<19			L80 B20	MacAdam			

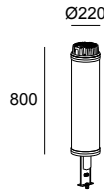

LED						
K	CRI	W Total	Real Lm	Code		
3000	80	59	4257	<b>60-3239 - Z5 - CL</b>	1-10V 100-240V	

●  
Z5

## Citizen Structure

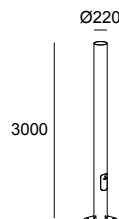

Code
<b>81-3239 - Z5 - Z5</b>

●  
Z5

## Accesorios de fijación Acessórios de fixação



Llave de puerta de entrada  
Chave de porta de entrada

Included



Pernos y plantilla  
Pernos e aros

Included

## Accesorios de reparación Acessórios de reparação



Pintura Z5 salva-rayadas  
Pintura Z5 contra-riscos

71-E117-Z5-00

# Proud

BODY MAT
AL

## Personalidad que se adapta al espacio Personalidade que se adapta ao espaço

El diseño del cabezal Proud aporta un plus de personalidad a los espacios donde se instala. Su instalación puede realizarse tanto en áreas de paso, donde es adecuada la versión asimétrica, como en áreas amplias, donde se recomienda el modelo simétrico.

O design da cabeça Proud dá personalidade aos espaços onde é instalada. A sua instalação pode ser realizada tanto em áreas de passagem, onde a versão assimétrica é adequada, como em grandes áreas, onde o modelo simétrico é recomendado.



### Proud Asymmetrical

IP 66	IK 10	UGR <22	DIF MAT PC	LOW FLICKER		BREEAM	50000h L80 B20	3 MacAdam	 0.4 m
----------	----------	------------	---------------	----------------	--	--------	-------------------	--------------	-----------

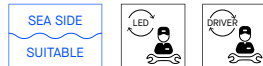

●  
Z5

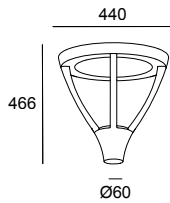

#### LED

K	CRI	W Total	Real Lm	Code	
3000	80	46.4	4879	<b>60-E082 - Z5 - CL</b>	ON-OFF 100-277V
4000	80	46.4	5227	<b>60-E082 - Z5 - CM</b>	ON-OFF 100-277V

### Proud Symmetrical

IP 66	IK 10	DIF MAT PC		BREEAM	50000h L80 B20	3 MacAdam	 0.4 m		
----------	----------	---------------	--	--------	-------------------	--------------	-----------	--	--

●  
Z5

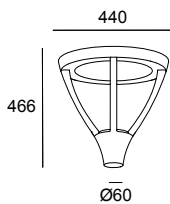

#### LED

K	CRI	W Total	Real Lm	Code	
3000	80	44.9	3110	<b>60-9913 - Z5 - CL</b>	ON-OFF 100-240V
3000	80	85.4	5223	<b>60-9996 - Z5 - CL</b>	ON-OFF 100-240V
4000	80	44.9	3110	<b>60-9913 - Z5 - CM</b>	ON-OFF 100-240V
4000	80	85.4	5695	<b>60-9996 - Z5 - CM</b>	ON-OFF 100-240V

**Proud Structure**

BODY MAT	SEA SIDE
AL	SUITABLE

●  
Z5

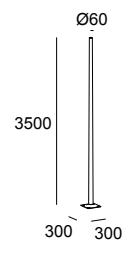

**Code**  
**81-E000 - Z5 - Z5**

**Accesorios de fijación**  
**Accesórios de fixação**



Pernos de fijación  
Pernos de fixação

**71-E213-48-48**

**Accesorios de reparación**  
**Accesórios de reparação**



Pintura Z5 salva-rayadas  
Pintura Z5 contra-riscos

**71-E117-Z5-00**

# Zigzag

Designed by Luca Turrini



+ Zigzag

## Diseño arquitectónico Design arquitetónico

El diseño elegante, de formas rectas y contemporáneas de Zigzag es una opción ideal para arquitecturas como las de museos, centros comerciales o universidades, ya que magnifica el ambiente donde se encuentra. El diseño y la calidad lumínica de esta colección está a la altura de las expectativas más exigentes.

O design elegante, de formas retas e contemporâneas da Zigzag é a escolha ideal para arquiteturas como as de museus, centros comerciais ou universidades, uma vez que amplia o ambiente onde se encontra. O design e a qualidade lumínica desta coleção está à altura das expetativas mais exigentes.



3000 mm

3650 mm



Ópticas Asimétricas  
Óticas Assimétricas



Ópticas Simétricas  
Óticas Simétricas

# Zigzag Symmetrical

BODY MAT
AL

## Zig-Zag Symmetrical

IP 65	IK 03	DIF MAT GLA	LOW FLICKER		BREEAM	50000h L80 B20	3 MacAdam		2.7 m	

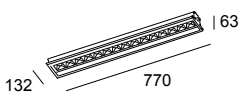

LED									
K	CRI	W Total	Real Lm	Optics	Code				
3000	80	63.4	4264	51°	<b>60-E102 - Z5 - CL</b>		1-10V	100-277V	
4000	80	63.4	4264	51°	<b>60-E102 - Z5 - CM</b>		1-10V	100-277V	

Z5

# Zigzag Asymmetrical

BODY MAT
AL

## Zig-Zag Asymmetrical

IP 65	IK 03	DIF MAT GLA		BREEAM	50000h L80 B20	3 MacAdam		2.7 m		

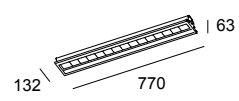
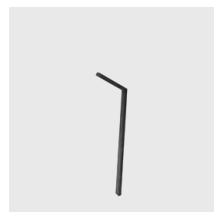

LED									
K	CRI	W Total	Real Lm	Optics	Code				
3000	80	62.1	5595	104°	<b>60-E000 - Z5 - CL</b>		0-10V	100-240V	
4000	80	62.1	5829	104°	<b>60-E000 - Z5 - CM</b>		0-10V	100-240V	

Z5

BODY MAT
AL

## Zig-Zag 3000mm Structure

SEA SIDE
SUITABLE

●  
Z5

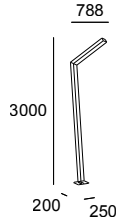
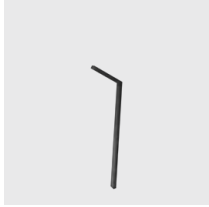

**Code**

**81-E102 - Z5 - Z5**

## Zig-Zag 3650mm Structure

SEA SIDE
SUITABLE

●  
Z5

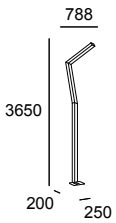

**Code**

**81-E103 - Z5 - Z5**

### Accesorios de reparación Acessórios de reparação



Pintura Z5 salva-rayadas  
Pintura Z5 contra-riscos

Z5 ●

**71-E117-Z5-00**





# Apliques

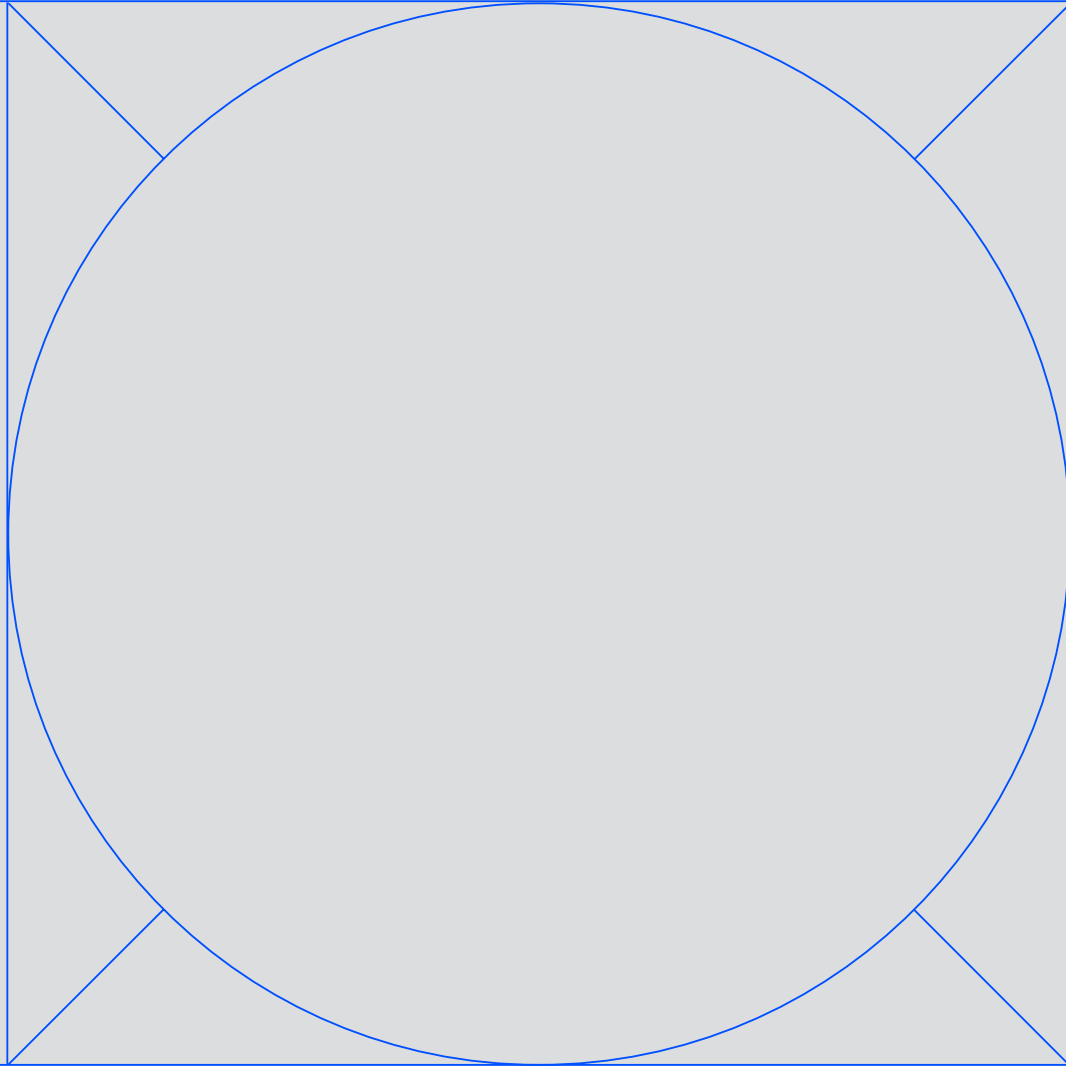

Modis  
856

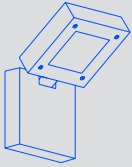

Max  
862

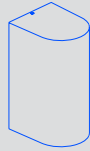

Cosmos  
868

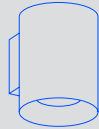

Afrodita  
872

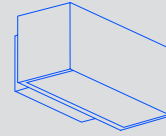

Nemesis  
884

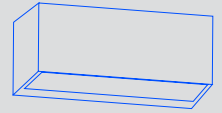

Wilson  
886

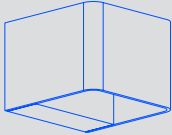

Clous  
888

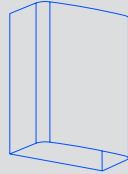

Simenti  
890

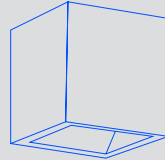

Diago  
891

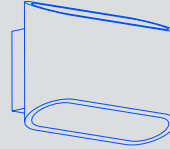

Venus  
892

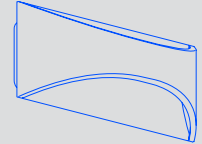

Finestra  
893

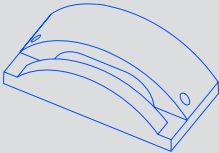

Arc  
896

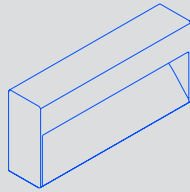

Sam  
898

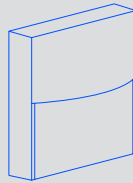

Kössel  
902

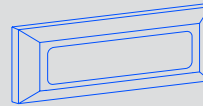

Cubus  
906

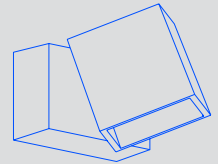

Darwin  
908

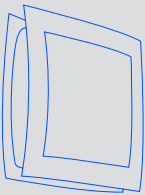

Skat  
909

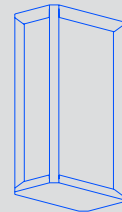

Rack  
910

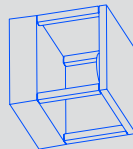

Curie  
916



Basic  
918

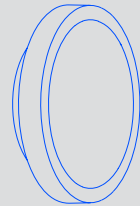

# Modis

Designed by Luca Turrini

FAMILIA/FAMILIA: Spotlight, Ceiling, Lampost, Bollard

## Versatilidad y movimiento Versatilidade e movimento

Modis aplique es la opción ideal para espacios que necesitan un plus de versatilidad y adaptación de la iluminación al ambiente. Tanto sus cabezales móviles como las diferentes extensiones de la estructura y la posibilidad de elección de ópticas, la convierten en la opción idónea para arquitecturas cuidadas al detalle. Modis aplique é a opção ideal para espaços que necessitam de um plus de versatilidade e adaptação da iluminação ao ambiente. Tanto as suas cabeças móveis como as diferentes extensões da estrutura e a possibilidade de escolha das óticas fazem dela a opção ideal para arquiteturas com atenção aos detalhes.



Opal



Optics



14

34

DL

E3

J6

Z5

60





# Modis

## Wall, Ceiling & Spotlight

BODY MAT	DIF MAT		50000h	3
AL	GLA		L80 B20	MacAdam

### Modis Opal Single

IP	IK	SWITCH CCT		SEA SIDE SUITABLE				
66	10	SW 2700-3200-4000						

● ● ● ● ● ● ● ●  
Z5 14\* 60\* 34\* J6\* E3\* DL\*

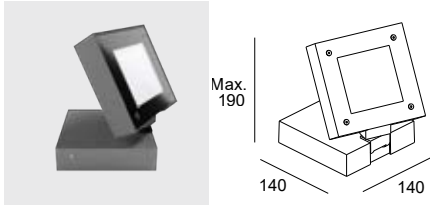

LED										
K	CRI	W Total	Real Lm	Optics	Code					
						Z5				
						J6				
						E3	OU	ON-OFF	100-277V	
SW 2700-3200-4000	80	13.2	744	107°	05-E062	- DL	- DU	DALI-2	100-277V	
						14	XB	CASAMBI	220-240V	
						60				
						34				

### Modis Opal Double 430mm

IP	IK	BREEAM	SWITCH CCT		SEA SIDE SUITABLE				
66	10		SW 2700-3200-4000						

● ● ● ● ● ● ● ●  
Z5 14\* 60\* 34\* J6\* E3\* DL\*

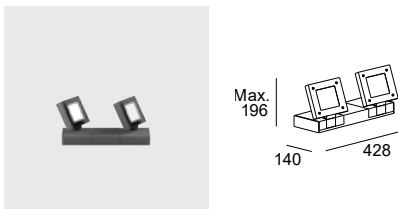

LED										
K	CRI	W Total	Real Lm	Optics	Code					
						Z5				
						J6				
						E3	OU	ON-OFF	100-277V	
SW 2700-3200-4000	80	2 x 13.2	1488	107°	05-E063	- DL	- DU	DALI-2	100-277V	
						14	XB	CASAMBI	220-240V	
						60				
						34				

### Modis Opal Double 800mm

IP	IK	BREEAM	SWITCH CCT		SEA SIDE SUITABLE				
66	10		SW 2700-3200-4000						

● ● ● ● ● ● ● ●  
Z5 14\* 60\* 34\* J6\* E3\* DL\*

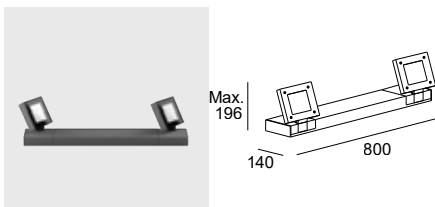

LED										
K	CRI	W Total	Real Lm	Optics	Code					
						Z5				
						J6				
						E3	OU	ON-OFF	100-277V	
SW 2700-3200-4000	80	2 x 13.2	1488	107°	05-E064	- DL	- DU	DALI-2	100-277V	
						14	XB	CASAMBI	220-240V	
						60				
						34				

## Modis Optics Simple

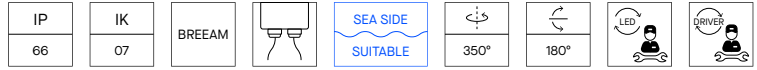

Ejemplo de código / Exemplo de código: **AS11-18V9S3OUZ5**

Model	W	K / Cri / Real lm	Optics	Source	Finishes
<b>AS11 -</b> 	<b>18</b> 20W	<b>V9</b> 2700K / CRI 90 / 1680 lm	<b>S3</b> 16°	<b>OU</b> ON-OFF 100-277V	<b>Z5*</b> <b>14*</b> <b>60*</b> <b>34*</b> <b>J6*</b> <b>E3*</b> <b>DL*</b>
		<b>W9</b> 3000K / CRI 90 / 1914 lm	<b>M3</b> 38°	<b>DS</b> DALI-2/PUSH 220-240V	
		<b>X9</b> 4000K / CRI 90 / 1966 lm	<b>F1</b> 48°	<b>XB</b> CASAMBI 220-240V	

## Modis Optics Double 430mm



Ejemplo de código / Exemplo de código: **AS12-37V9S3OUZ5**

Model	W	K / Cri / Real lm	Optics	Source	Finishes
<b>AS12 -</b> 	<b>37</b> 2 x 20W	<b>V9</b> 2700K / CRI 90 / 3360 lm	<b>S3</b> 16°	<b>OU</b> ON-OFF 100-277V	<b>Z5</b> <b>14*</b> <b>60*</b> <b>34*</b> <b>J6*</b> <b>E3*</b> <b>DL*</b>
		<b>W9</b> 3000K / CRI 90 / 3828 lm	<b>M3</b> 38°	<b>DS</b> DALI-2/PUSH 220-240V	
		<b>X9</b> 4000K / CRI 90 / 3932 lm	<b>F1</b> 48°	<b>XB</b> CASAMBI 220-240V	

## Modis Optics Double 800mm



Ejemplo de código / Exemplo de código: **AS13-37V9S3OUZ5**

Model	W	K / Cri / Real lm	Optics	Source	Finishes
<b>AS13 -</b> 	<b>37</b> 2 x 20W	<b>V9</b> 2700K / CRI 90 / 3360 lm	<b>S3</b> 16°	<b>OU</b> ON-OFF 100-277V	<b>Z5</b> <b>14*</b> <b>60*</b> <b>34*</b> <b>J6*</b> <b>E3*</b> <b>DL*</b>
		<b>W9</b> 3000K / CRI 90 / 3828 lm	<b>M3</b> 38°	<b>DS</b> DALI-2/PUSH 220-240V	
		<b>X9</b> 4000K / CRI 90 / 3932 lm	<b>F1</b> 48°	<b>XB</b> CASAMBI 220-240V	



Modis Opal Single

Modis Opal  
Double 430mmModis Opal  
Double 800mm**Accesorios ópticos**  
Acessórios óticosVisera  
Viseira

Z5 ●	71-E234-Z5-00	71-E234-Z5-00	71-E234-Z5-00
J6 ● *	71-E234-J6-00	71-E234-J6-00	71-E234-J6-00
E3 ● *	71-E234-E3-00	71-E234-E3-00	71-E234-E3-00
DL ● *	71-E234-DL-00	71-E234-DL-00	71-E234-DL-00
14 ○ *	71-E234-14-00	71-E234-14-00	71-E234-14-00
60 ● *	71-E234-60-00	71-E234-60-00	71-E234-60-00
34 ○ *	71-E234-34-00	71-E234-34-00	71-E234-34-00

**Accesorios de fijación**  
Acessórios de fixaçãoEstaca de 302mm  
Estaca de 302 mm

71-9998-05-05

-

-

Estaca de 235mm  
Estaca de 235 mm

71-9997-05-05

-

-

**Accesorios de unión**  
Acessórios de uniãoPlaca concatenadora  
Placa de união

Z5 ●	-	71-E235-Z5-00	71-E235-Z5-00
J6 ● *	-	71-E235-J6-00	71-E235-J6-00
E3 ● *	-	71-E235-E3-00	71-E235-E3-00
DL ● *	-	71-E235-DL-00	71-E235-DL-00
14 ○ *	-	71-E235-14-00	71-E235-14-00
60 ● *	-	71-E235-60-00	71-E235-60-00
34 ○ *	-	71-E235-34-00	71-E235-34-00

Modis Optics  
SimpleModis Optics  
Double 430mmModis Optics  
Double 800mm

### Accesorios ópticos

#### Acessórios óticos

Visera  
Viseira

Z5 ●	71-E234-Z5-00	71-E234-Z5-00	71-E234-Z5-00
J6 ● *	71-E234-J6-00	71-E234-J6-00	71-E234-J6-00
E3 ● *	71-E234-E3-00	71-E234-E3-00	71-E234-E3-00
DL ● *	71-E234-DL-00	71-E234-DL-00	71-E234-DL-00
14 ○ *	71-E234-14-00	71-E234-14-00	71-E234-14-00
60 ● *	71-E234-60-00	71-E234-60-00	71-E234-60-00
34 ○ *	71-E234-34-00	71-E234-34-00	71-E234-34-00

### Accesorios de fijación

#### Acessórios de fixação

Estaca de 302mm  
Estaca de 302 mm

71-9998-05-05

-

-

Estaca de 235mm  
Estaca de 235 mm

71-9997-05-05

-

-

### Accesorios de unión

#### Acessórios de união

Placa concatenadora  
Placa de união

Z5 ●	-	71-E235-Z5-00	71-E235-Z5-00
J6 ● *	-	71-E235-J6-00	71-E235-J6-00
E3 ● *	-	71-E235-E3-00	71-E235-E3-00
DL ● *	-	71-E235-DL-00	71-E235-DL-00
14 ○ *	-	71-E235-14-00	71-E235-14-00
60 ● *	-	71-E235-60-00	71-E235-60-00
34 ○ *	-	71-E235-34-00	71-E235-34-00

# Max

Designed by LedsC4 Architectural



+ Max

**FAMILIAS/FAMILIAS:** Downlights, Uplights, Spotlight, Ceiling



## Lo mejor del diseño interior aplicado al exterior O melhor do design interior aplicado ao exterior

Los apliques Max son especialmente adecuados para proyectos donde necesitamos una única familia de luminarias tanto para el interior como para el exterior. Gracias a su diseño con tornillería oculta, su extensa gama de opciones y sus altas prestaciones, se adapta con facilidad a los proyectos más exigentes. Os apliques Max são particularmente adequados para projetos em que é necessária uma única família de luminárias tanto para o interior como para o exterior. Graças ao seu design com parafusos ocultos, a sua extensa gama de opções e o seu elevado desempenho, adapta-se com facilidade aos projetos mais exigentes.

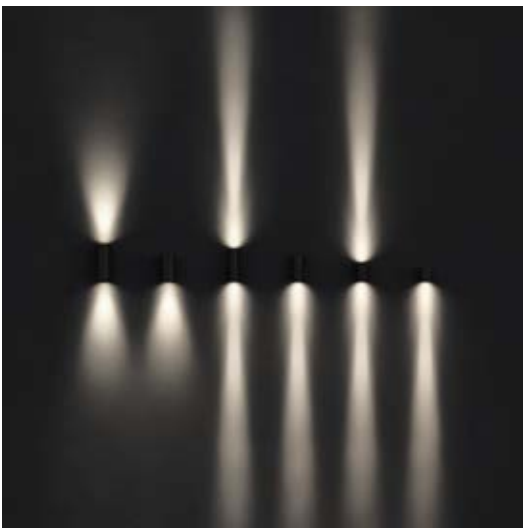

14

34

DL

E3

J6

Z5

60







# Max

## Wall Fixture

BODY MAT	DIF MAT		50000h	2
AL	GLA		L80 B20	MacAdam

## Max Medium Wall Fixture Single Emission

IP	IK	SEA SIDE	LED	DRIVER
66	10	SUITABLE		

Ejemplo de código / Exemplo de código: **AI19-P4V9S10SZ5**

Model	W	K / Cri / Real lm	Optics	Source	Finishes	
 <b>AI19 -</b> Emisión Simple Emissão mono	<b>P4</b> 6W	<b>V9</b> 2700K / CRI 90 / 286 lm	<b>S1</b> 9°	<b>OS</b> ON-OFF 220-240V	<b>Z5</b> <b>14*</b> <b>34*</b> <b>60*</b> <b>DL*</b> <b>E3*</b> <b>J6*</b>	
		<b>W9</b> 3000K / CRI 90 / 286 lm				
		<b>X9</b> 4000K / CRI 90 / 286 lm				
	<b>P7</b> 9.1W	<b>V9</b> 2700K / CRI 90 / 519 lm	<b>S2</b> 17°	<b>OS</b> ON-OFF 220-240V		
		<b>W9</b> 3000K / CRI 90 / 459 lm				<b>M2</b> 27°
		<b>X9</b> 4000K / CRI 90 / 423 lm				

## Max Medium Wall Fixture Single Emission Dimming

IP	IK	SEA SIDE	LED	DRIVER
66	10	SUITABLE		

Ejemplo de código / Exemplo de código: **AI23-P6V9S1DUZ5**

Model	W	K / Cri / Real lm	Optics	Source	Finishes
 <b>AI23 -</b> Emisión Simple Emissão mono	<b>P6</b> 8W	<b>V9</b> 2700K / CRI 90 / 373 lm	<b>S1</b> 9°	<b>DU</b> DALI-2 100-277V	<b>Z5</b> <b>14*</b> <b>34*</b> <b>60*</b> <b>DL*</b> <b>E3*</b> <b>J6*</b>
		<b>W9</b> 3000K / CRI 90 / 373 lm		<b>XB</b> CASAMBI 220-240V	
		<b>X9</b> 4000K / CRI 90 / 373 lm			
	<b>P8</b> 10.4W	<b>V9</b> 2700K / CRI 90 / 610 lm	<b>S2</b> 17°	<b>DU</b> DALI-2 100-277V	
		<b>W9</b> 3000K / CRI 90 / 540 lm		<b>XB</b> CASAMBI 220-240V	
		<b>X9</b> 4000K / CRI 90 / 498 lm			

## Max Big Wall Fixture Single Emission

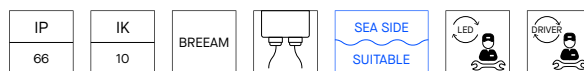

Ejemplo de código / Exemplo de código: **AT19-18V9S3OSZ5**

Model	W	K / Cri / Real lm	Optics	Source	Finishes
 <p><b>AT19 -</b> Emisión Simple Emissão mono</p> 	<b>18</b> 19.6W	<b>V9</b> 2700K / CRI 90 / 1985 lm	<b>S3</b> 21°	<b>OS</b> ON-OFF 220-240V	<b>Z5</b> <b>14*</b> <b>34*</b> <b>60*</b> <b>DL*</b> <b>E3*</b> <b>J6*</b>
		<b>W9</b> 3000K / CRI 90 / 2047 lm	<b>M3</b> 31°	<b>DU</b> DALI-2 100-277V	
		<b>X9</b> 4000K / CRI 90 / 1803 lm	<b>F1</b> 40°	<b>XB</b> CASAMBI 220-240V	

## Max Medium Wall Fixture Double Emission



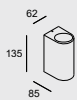

Ejemplo de código / Exemplo de código: **AI21-P8V9S1OSZ5**

Model	W	K / Cri / Real lm	Optics	Source	Finishes
 <p><b>AI21 -</b> Emisión Doble Emissão dupla</p> 	<b>P8</b> 10W	<b>V9</b> 2700K / CRI 90 / 572 lm	<b>S1</b> 9° + 9°	<b>OS</b> ON-OFF 220-240V/50-60Hz	<b>Z5</b> <b>14*</b> <b>34*</b> <b>60*</b> <b>DL*</b> <b>E3*</b> <b>J6*</b>
		<b>W9</b> 3000K / CRI 90 / 572 lm			
		<b>X9</b> 4000K / CRI 90 / 572 lm			
	<b>11</b> 13W	<b>V9</b> 2700K / CRI 90 / 805 lm	<b>S7</b> 9° + 17°	<b>OS</b> ON-OFF 220-240V/50-60Hz	
		<b>W9</b> 3000K / CRI 90 / 745 lm	<b>S8</b> 9° + 27°		
		<b>X9</b> 4000K / CRI 90 / 709 lm	<b>S9</b> 9° + 50°		
	<b>13</b> 15.5W	<b>V9</b> 2700K / CRI 90 / 1038 lm	<b>S2</b> 17° + 17°	<b>OS</b> ON-OFF 220-240V/50-60Hz	
		<b>W9</b> 3000K / CRI 90 / 918 lm	<b>M2</b> 27° + 27°		
		<b>X9</b> 4000K / CRI 90 / 846 lm	<b>F1</b> 50° + 50°		
			<b>M5</b> 27° + 50°		
			<b>S5</b> 17° + 27°		
			<b>S6</b> 17° + 50°		

# Max Medium Wall Fixture Double Emission Dimming

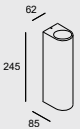

Ejemplo de código / Exemplo de código: **AI24-12V9S1DUZ5**

Model	W	K / Cri / Real lm	Optics	Source	Finishes	
 <b>AI24 -</b> Emisión Doble Emissão dupla  	<b>12</b> 15W	<b>V9</b> 2700K / CRI 90 / 747 lm	<b>S1</b> 9° + 9°	<b>DU</b> DALI-2 100-277V	<b>Z5</b> <b>14*</b> <b>34*</b> <b>60*</b> <b>DL*</b> <b>E3*</b> <b>J6*</b>	
		<b>W9</b> 3000K / CRI 90 / 747 lm		<b>XB</b> CASAMBI 220-240V		
		<b>X9</b> 4000K / CRI 90 / 747 lm				
	<b>14</b> 17W	<b>V9</b> 2700K / CRI 90 / 957 lm	<b>S7</b> 9° + 17°	<b>DU</b> DALI-2 100-277V		
		<b>W9</b> 3000K / CRI 90 / 887 lm		<b>S8</b> 9° + 27°		<b>XB</b> CASAMBI 220-240V
		<b>X9</b> 4000K / CRI 90 / 844 lm		<b>S9</b> 9° + 50°		
	<b>17</b> 22W	<b>V9</b> 2700K / CRI 90 / 1221 lm	<b>S2</b> 17° + 17°	<b>DU</b> DALI-2 100-277V		
		<b>W9</b> 3000K / CRI 90 / 1080 lm		<b>M2</b> 27° + 27°		<b>XB</b> CASAMBI 220-240V
		<b>X9</b> 4000K / CRI 90 / 995 lm	<b>F1</b> 50° + 50°			
<b>M5</b> 27° + 50°						
<b>S5</b> 17° + 27°						
<b>S6</b> 17° + 50°						

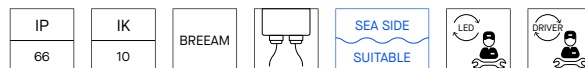

# Max Big Wall Fixture Double Emission



Ejemplo de código / Exemplo de código: **AT21-33V9S3OSZ5**





Model	W	K / Cri / Real lm	Optics	Source	Finishes
 <b>AT21 -</b> Emisión Doble Emissão dupla  	<b>33</b> 34.8W	<b>V9</b> 2700K / CRI 90 / 3367 lm	<b>S3</b> 21° + 21°	<b>OS</b> ON-OFF 220-240V	<b>Z5</b> <b>14*</b> <b>34*</b> <b>60*</b> <b>E3*</b> <b>J6*</b>
		<b>W9</b> 3000K / CRI 90 / 3736 lm		<b>M3</b> 31° + 31°	
		<b>X9</b> 4000K / CRI 90 / 3291 lm	<b>F1</b> 39° + 39°	<b>XB</b> CASAMBI 220-240V	
			<b>M5</b> 31° + 39°		
			<b>S5</b> 21° + 31°		
			<b>S6</b> 21° + 39°		



		Max Medium Wall Fixture Single Emission	Max Medium Wall Fixture Single Emission Dimming	Max Big Wall Fixture Single Emission
				

### Accesorios ópticos



#### Accessórios óticos

	Difusor wall washer (5u.) Wall washer diffuser (5u.)	71-E463-00-00	71-E463-00-00	71-E464-00-00
	Panel de abeja (5u.) Painel de abelha (5u.)	71-E131-00-00	71-E131-00-00	71-E263-00-00
	Difusor cuadrado (5u.) Difusor quadrado (5u.)	71-E135-00-00	71-E135-00-00	71-E262-00-00
	Difusor elíptico (5u.) Difusor elíptico (5u.)	71-E141-00-00	71-E141-00-00	71-E261-00-00
	Difusor opal (5u.) Difusor opal (5u.)	71-E133-00-00	71-E133-00-00	71-E260-00-00

### Accesorios de fijación





#### Accessórios de fixação

	Ventosa extracción Ventosa extração	71-E137-00-00	71-E137-00-00	-
-------------------------------------------------------------------------------------	----------------------------------------	---------------	---------------	---

		Max Medium Wall Fixture Double Emission	Max Medium Wall Fixture Double Emission Dimming	Max Big Wall Fixture Double Emission
				

### Accesorios ópticos

#### Accessórios óticos

	Difusor wall washer (5u.) Wall washer diffuser (5u.)	71-E463-00-00	71-E463-00-00	71-E464-00-00
	Panel de abeja (5u.) Painel de abelha (5u.)	71-E131-00-00	71-E131-00-00	71-E263-00-00
	Difusor cuadrado (5u.) Difusor quadrado (5u.)	71-E135-00-00	71-E135-00-00	71-E262-00-00
	Difusor elíptico (5u.) Difusor elíptico (5u.)	71-E141-00-00	71-E141-00-00	71-E261-00-00
	Difusor opal (5u.) Difusor opal (5u.)	71-E133-00-00	71-E133-00-00	71-E260-00-00

### Accesorios de fijación

#### Accessórios de fixação

	Ventosa extracción Ventosa extração	71-E137-00-00	71-E137-00-00	-
-------------------------------------------------------------------------------------	----------------------------------------	---------------	---------------	---

# Cosmos

Designed by LedsC4 Architectural

FAMILIA/FAMILIA: Ceiling

## Elegante y versátil Elegante e versátil

La colección Cosmos está diseñada bajo el concepto deco-tech y tiene la finalidad de iluminar fachadas de hoteles, áreas públicas y residencias, aportando un toque decorativo. La tornillería oculta y los accesorios incluidos la convierten en una familia muy utilizada por su gran polivalencia gracias, en parte, a sus modelos con mono y doble emisión.

A coleção Cosmos foi projetada sob o conceito deco-tech e tem a finalidade de iluminar fachadas de hotéis, áreas públicas e residências, dando um toque decorativo. Os parafusos ocultos e os acessórios incluídos tornam-na uma família amplamente utilizada pela sua grande versatilidade graças, em parte, aos seus modelos com emissão mono e dupla.



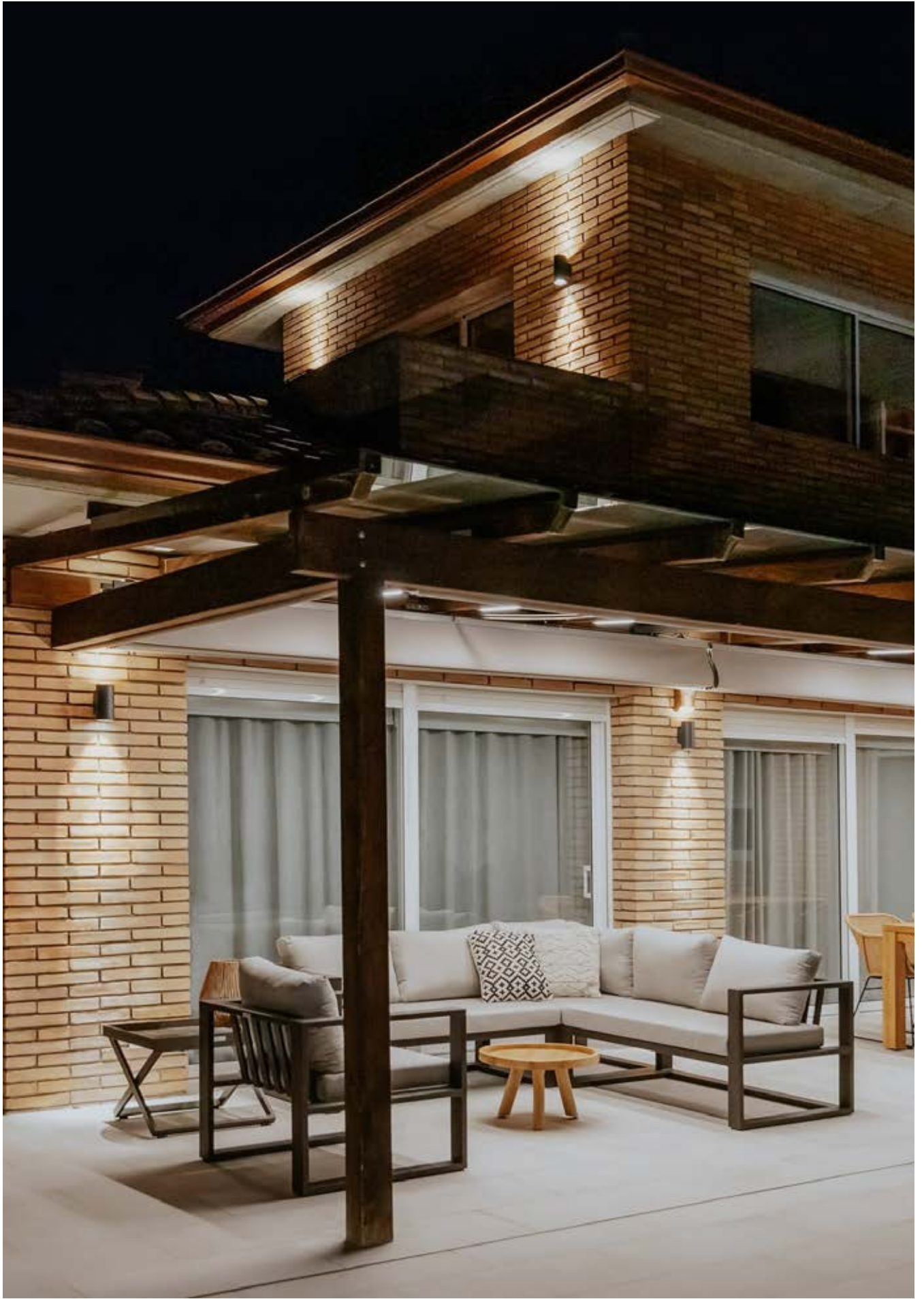

# Cosmos

## Wall Fixture

BODY MAT	DIF MAT		50000h	3
AL	GLA		L80 B20	MacAdam

### Cosmos Wall Fixture Single Emission 85mm

IP	IK	BREEAM		
66	06			

●  
Z5

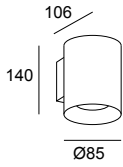

LED							
K	CRI	W Total	Real Lm	Optics	Code		
3000	80	12.7	760	17°	<b>05-9952 - Z5 - CL</b>	ON-OFF 100-240V	
4000	80	12.7	819	17°	<b>05-9952 - Z5 - CM</b>	ON-OFF 100-240V	



### Cosmos Wall Fixture Single Emission 110mm

IP	IK	BREEAM		
66	06			

●  
Z5

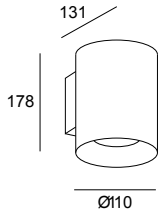

LED							
K	CRI	W Total	Real Lm	Optics	Code		
3000	80	25.4	1823	16°;34°	<b>05-9954 - Z5 - CL</b>	ON-OFF 100-240V	
4000	80	25.4	1823	16°;34°	<b>05-9954 - Z5 - CM</b>	ON-OFF 100-240V	



### Cosmos Wall Fixture Single Emission 144mm

IP	IK	BREEAM		
66	07			

●  
Z5

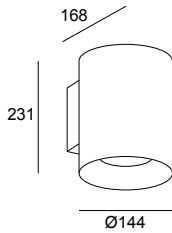

LED							
K	CRI	W Total	Real Lm	Optics	Code		
3000	80	36	2367	16°;34°	<b>05-9956 - Z5 - CL</b>	ON-OFF 100-240V	
4000	80	36	2534	16°;34°	<b>05-9956 - Z5 - CM</b>	ON-OFF 100-240V	



### Cosmos Wall Fixture Double Emission 85mm

IP	IK	BREEAM		
66	06			

●  
Z5

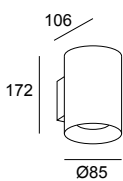

LED							
K	CRI	W Total	Real Lm	Optics	Code		
3000	80	11.8	625	17°	<b>05-9953 - Z5 - CL</b>	ON-OFF 100-240V	
4000	80	11.8	960	17°	<b>05-9953 - Z5 - CM</b>	ON-OFF 100-240V	



**Cosmos Wall Fixture Double  
Emission 110mm**

IP	IK	BREEAM	LED	DRIVER
66	06			

Z5

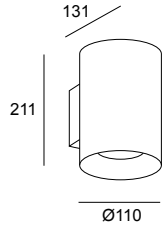

LED							
K	CRI	W Total	Real Lm	Optics	Code		
3000	80	24.5	1823	16°;34°	<b>05-9955 - Z5 - CL</b>		ON-OFF 100-240V
4000	80	24.5	1823	16°;34°	<b>05-9955 - Z5 - CM</b>		ON-OFF 100-240V



**Cosmos Wall Fixture Double  
Emission 144mm**

IP	IK	BREEAM	LED	DRIVER
66	07			

Z5

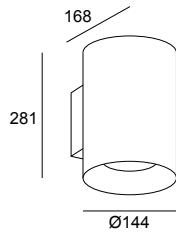

LED							
K	CRI	W Total	Real Lm	Optics	Code		
3000	80	35	2710	16°;34°	<b>05-9957 - Z5 - CL</b>		ON-OFF 100-240V
4000	80	35	2901	16°;34°	<b>05-9957 - Z5 - CM</b>		ON-OFF 100-240V



**Cosmos Wall  
Fixture Single  
Emission 85mm**



**Cosmos Wall  
Fixture Single  
Emission 110mm**



**Cosmos Wall  
Fixture Single  
Emission 144mm**



**Accesorios ópticos  
Acessórios óticos**



Set de 2 reflectores (20° y 44°)  
Set de 2 refletores (20° e 44°)

Included

Included

Included

**Accesorios decorativos  
Acessórios decorativos**



Set de 2 decorreflector (plata y dorado)  
Set de 2 decorrefletor (prata e dourado)

Included

Included

Included

**Cosmos Wall  
Fixture Double  
Emission 85mm**



**Cosmos Wall  
Fixture Double  
Emission 110mm**



**Cosmos Wall  
Fixture Double  
Emission 144mm**



**Accesorios ópticos  
Acessórios óticos**



Set de 2 reflectores (20° y 44°)  
Set de 2 refletores (20° e 44°)

Included

Included

Included

**Accesorios decorativos  
Acessórios decorativos**



Set de 2 decorreflector (plata y dorado)  
Set de 2 decorrefletor (prata e dourado)

Included

Included

Included

# Afrodita

Designed by LedsC4 Architectural



+ Afrodita

FAMILIA/FAMILIA: Ceiling

Emblemática colección  
de apliques de exterior  
Emblemática coleção de  
apliques de exterior



**Afrodita Infinite**  
**875**

Integración arquitectónica  
Integração arquitetónica

**Afrodita Tech**  
**877**

Efectos de luz  
Efeitos de luz

**Afrodita LED**  
**879**

Luz general  
Luz geral

**Afrodita Power LED**  
**881**

Luz vertical  
Luz vertical

**Afrodita GU10**  
**883**

Uso con bombilla  
Uso com lâmpada

**Mono emission**

1000 × 105 mm

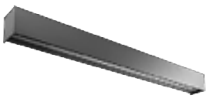

120 × 120 mm



220 × 90 mm

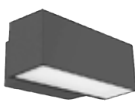

100 × 135 mm



83 × 115 mm



215 × 215 mm



300 × 120 mm

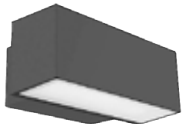

100 × 150 mm



**Double emission**

1000 × 105 mm

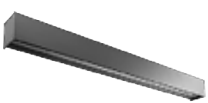

120 × 120 mm



220 × 90 mm

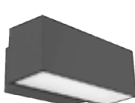

100 × 135 mm



215 × 215 mm



300 × 120 mm

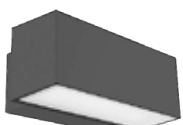

100 × 150 mm



83 × 208 mm



20.3 - 29 W



12 - 37.8 W



11.5 - 39 W  
Emergency



10.5 - 17.4 W



1 / 2 x max. 8 W



F

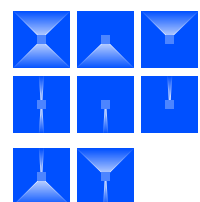

F



F



M



F

**F:** Flood (63°-90°) **M:** Medium (22°-26°)



# Afrodita Infinite



Fácil de concatenar, con uniones prácticamente invisibles

Fácil de concatenar, com uniões praticamente invisíveis

## Iluminación regulable

## Iluminação regulável

En el momento de la instalación, una sola referencia permite elegir opción mono y doble emisión; y dos direcciones del haz de luz.

No momento da instalação, uma única referência permite escolher a opção mono e dupla emissão; e duas direções do feixe de luz.



## Concatenación

## Concatenação

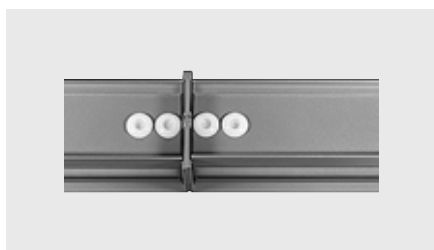

# Afrodita

## Infinite

BODY MAT  
AL

DIF MAT  
GLA



OUTDOOR

IP  
66

IK  
04

LOW  
FLICKER

50000h  
L80 B20

3  
MacAdam



SEA SIDE  
SUITABLE

Z5 14

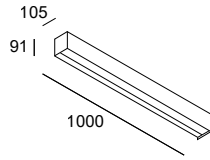

LED						
K	CRI	W Total	Real Lm	Optics	Code	
3000	80	32.5	2083	90°	05-E052	DALI-2 100-240V
					05-E084 - Z5	O-10V 100-240V
					05-E086 - 14 - CL	CASAMBI 220-240V
4000	80	32.5	2083	90°	05-E052	DALI-2 100-240V
					05-E084 - Z5	O-10V 100-240V
					05-E086 - 14 - CM	CASAMBI 220-240V

APLIQUES | APLIQUES

# Afrodita Tech



Marcados efectos de luz, amplios o concentrados, gracias a sus accesorios  
 Marcados efeitos de luz, amplos ou concentrados, graças aos seus acessórios

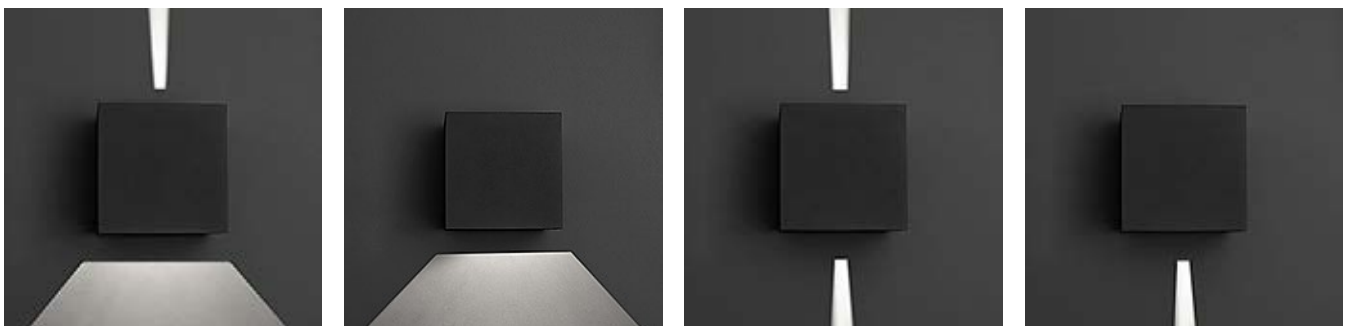

Accesorio para luz concentrada incluido en los modelos pequeños y opcional en los modelos grandes.  
 Acessórios para luz concentrada incluído nos modelos pequenos e opcional nos modelos grandes.

## Afrodita Tech

BODY MAT	DIF MAT	
AL	GLA	

### Afrodita Tech Small Single Emission

IP 65	IK 05	50000h L80 B20	3 MacAdam	SEA SIDE SUITABLE		
----------	----------	-------------------	--------------	----------------------	--	--

Z5

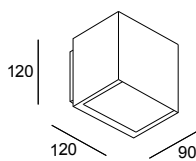

LED							
K	CRI	W Total	Real Lm	Optics	Code		
3000	80	7.1	180	68°	<b>05-E081 - Z5 - CL</b>		ON-OFF 100-277V
4000	80	7.1	180	68°	<b>05-E081 - Z5 - CM</b>		ON-OFF 100-277V



## Afrodita Tech Big Single Emission

IP	IK	50000h	2		SEA SIDE SUITABLE		
66	07	L80 B20	MacAdam				

Z5

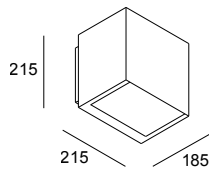

### LED

K	CRI	W Total	Real Lm	Optics	Code	
3000	80	22.3	721	63°	<b>05-E079 - Z5 - CL</b>	0-10V 100-240V
4000	80	22.3	721	63°	<b>05-E079 - Z5 - CM</b>	0-10V 100-240V



## Afrodita Tech Small Double Emission

IP	IK	50000h	3		SEA SIDE SUITABLE		
65	05	L80 B20	MacAdam				

Z5

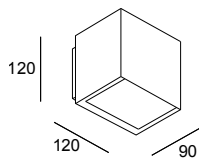

### LED

K	CRI	W Total	Real Lm	Optics	Code	
3000	80	13.9	360	68°	<b>05-E080 - Z5 - CL</b>	ON-OFF 100-277V
4000	80	13.9	360	68°	<b>05-E080 - Z5 - CM</b>	ON-OFF 100-277V



## Afrodita Tech Big Double Emission

IP	IK	50000h	2		SEA SIDE SUITABLE		
66	07	L80 B20	MacAdam				

Z5

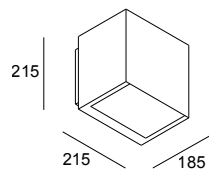

### LED

K	CRI	W Total	Real Lm	Optics	Code	
3000	80	43.7	1441	63°	<b>05-E078 - Z5 - CL</b>	0-10V 100-240V
4000	80	43.7	1441	63°	<b>05-E078 - Z5 - CM</b>	0-10V 100-240V



### Afrodita Tech Small Single Emission



### Afrodita Tech Big Single Emission



### Afrodita Tech Small Double Emission



### Afrodita Tech Big Double Emission



## Accesorios ópticos Acessórios óticos



Lupa haz de luz estrecho  
Lente feixe de luz estreito

Z5 ●

Included

71-E078-Z5-00

-

71-E078-Z5-00

Included

-

-

-



Lupa haz de luz estrecho (2u.)  
Lupa feixe de luz estreito (2u.)

-

-

Included

-

# Afrodita Led



La más especificada,  
el Up&Down clásico  
A mais especificada,  
o Up&down clássico

Smart

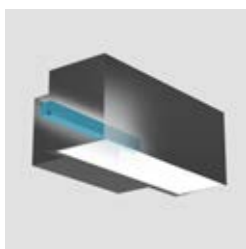

Opción mono y doble emisión  
Opção emissão mono e dupla

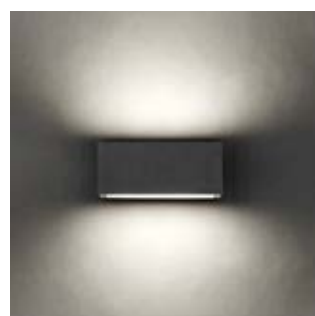
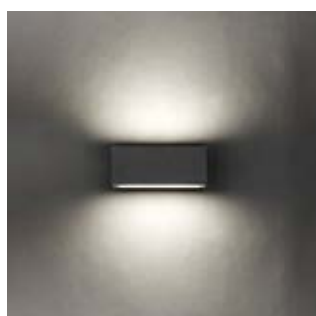

## Afrodita LED 220mm Single Emission

IP	IK	50000h	BREEAM	3	SEA SIDE SUITABLE	LED	DRIVER
65	04	L80 B20		MacAdam			

Z5 14 34

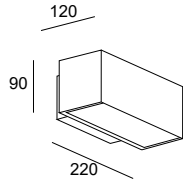

LED							
K	CRI	W Total	Real Lm	Optics	Code		
						Z5	
3000	80	12.7	913	90°	05-9912 - 14 - CL	ON-OFF	100-240V
					34		
4000	80	12.7	1004	90°	05-9912 - Z5 - CM	ON-OFF	100-240V



## Afrodita LED 300mm Single Emission

IP	IK	50000h	BREEAM	3	SEA SIDE SUITABLE	LED	DRIVER
66	04	L80 B20		MacAdam			

Z5 14 34

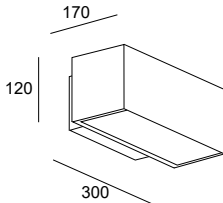
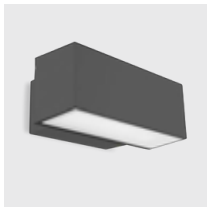

LED							
K	CRI	W Total	Real Lm	Optics	Code		
						Z5	
3000	80	23.3	1949	88°	05-9879 - 14 - CL	ON-OFF	100-240V
					05-E020 - 14 - CL	CASAMBI	100-240V
					05-E047 - 34	DALI-2	100-240V
					05-9879	ON-OFF	100-240V
4000	80	23.3	2144	88°	05-E020 - Z5 - CM	CASAMBI	100-240V
					05-E047	DALI-2	100-240V



## Afrodita LED 220mm Double Emission

IP	IK	BREEAM	50000h	3	SEA SIDE SUITABLE	LED	DRIVER
65	04		L80 B20	MacAdam			

Z5 14 34

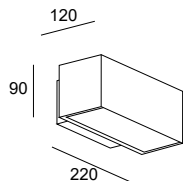
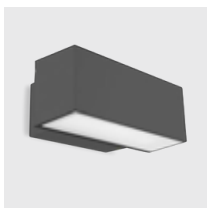

LED							
K	CRI	W Total	Real Lm	Optics	Code		
						Z5	
3000	80	17.9	1494	88°	05-9911 - 14 - CL	ON-OFF	100-240V
					34		
4000	80	17.9	1644	88°	05-9911 - Z5 - CM	ON-OFF	100-240V



## Afrodita LED 300mm Double Emission

IP	IK	LOW	BREEAM	50000h	3	SEA SIDE SUITABLE	LED	DRIVER
66	04	FLICKER		L80 B20	MacAdam			

Z5 14 34

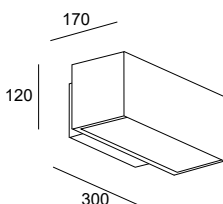

LED							
K	CRI	W Total	Real Lm	Optics	Code		
						Z5	
3000	80	40.7	3485	88°	05-E021 - 14 - CL	CASAMBI	220-240V
					05-E048 - 14 - CL	DALI-2	220-240V
					05-E070 - 34	ON-OFF	220-240V
					05-E021	CASAMBI	220-240V
4000	80	40.7	3376	88°	05-E048 - Z5 - CM	DALI-2	220-240V
					05-E070	ON-OFF	220-240V



# Afrodita Power Led



La más utilizada para proyectar luz verticalmente  
 A mais utilizada para projetar luz verticalmente



14

34

DL

E3

J6

Z5

60





# Afrodita

## Power LED

BODY MAT
AL

DIF MAT
GLA



### Afrodita Power LED Single Emission

IP
65

IK
10

LOW
FLICKER

BREEAM
--------

50000h
L80 B20

3
MacAdam

SEA SIDE
SUITABLE



Z5 14\* 60\* 34\* J6\* E3\* DL\*

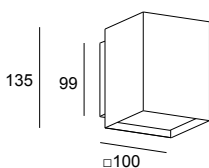

LED										
K	CRI	W Total	Real Lm	Optics	Code					
						Z5				
						J6				
						E3				
3000	80	13	1136	26°	05-E056	- DL - CL	ON-OFF	100-240V		
						14				
						60				
						34				
						Z5				
						J6				
						E3				
4000	80	13	1136	26°	05-E056	- DL - CM	ON-OFF	100-240V		
						14				
						60				
						34				

### Afrodita Power LED Double Emission

IP
55

IK
04

50000h
L80 B20

3
MacAdam

SEA SIDE
SUITABLE



Z5 14\* 60\* 34\* J6\* E3\* DL\*

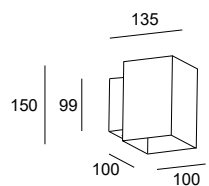

LED									
K	CRI	W Total	Real Lm	Optics	Code				
						Z5			
						J6			
						E3			
3000	80	21.6	1324	22°	05-9773	- DL - 37	ON-OFF	100-240V	
						14			
						60			
						34			
						Z5			
						J6			
						E3			
4000	80	21.6	1390	22°	05-9773	- DL - CM	ON-OFF	100-240V	
						14			
						60			
						34			

# Afrodita GU10



El mismo diseño,  
con bombillas GU10  
O mesmo design,  
com lâmpadas GU10

## Mono emission



## Double emission



# Afrodita

## GU10

BODY MAT
AL

DIF MAT
GLA



### Afrodita GU10 Single Emission

IP
65

IK
10

SEA SIDE
SUITABLE

● ○ ●  
Z5 14 34

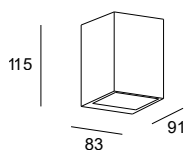

GU10	
<b>W</b>	<b>Code</b>
Max. 8	<b>Z5</b>
	<b>05-E054 - 14 - 37</b>
	<b>34</b>



### Afrodita GU10 Double Emission

IP
55

IK
06

SEA SIDE
SUITABLE

● ○ ●  
Z5 14 34

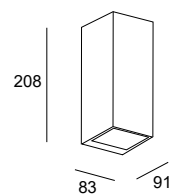

GU10	
<b>W</b>	<b>Code</b>
2 × Max. 8	<b>Z5</b>
	<b>05-9919 - 14 - 37</b>
	<b>34</b>



# Nemesis

Designed by LedsC4 Architectural



## Colección fachadas de uso residencial Coleção para fachadas de uso residencial

El diseño atemporal y el tamaño compacto de los apliques Nemesis, junto con su contrastada fiabilidad, han convertido esta colección en una de las más utilizadas en fachadas de residencias. El aplique permite elegir entre mono y doble emisión en el mismo momento de la instalación, lo que le aporta un plus de versatilidad muy útil en proyectos.

O design intemporal e o tamanho compacto dos apliques Nemesis, juntamente com a sua fiabilidade comprovada, fizeram desta coleção uma das mais utilizadas nas fachadas residenciais. O aplique permite escolher entre emissão mono e dupla aquando da instalação, o que lhe confere um plus de versatilidade que é muito útil nos projetos.

# Nemesis

BODY MAT	DIF MAT	
AL	GLA	

## Nemesis LED 170mm

IP 65	IK 06	BREEAM	50000h L80 B20	3 MacAdam	SWITCH CCT SW 2700-3200-4000	SEA SIDE SUITABLE		
----------	----------	--------	-------------------	--------------	---------------------------------	----------------------	--	--

● Z5 ○ 14 ● 34 ● J6

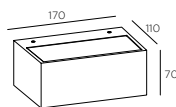

LED									
K	CRI W Total Real Lm Code								
SW 2700-3200-4000	80	12.6	834	05-E026	Z5	J6	-	EH	ON-OFF 100-240V
					14				
					34				



### Nemesis LED 220mm

IP	IK	LOW	50000h	BREEAM	3	SWITCH CCT	SEA SIDE	LED	DRIVER
65	04	FLICKER	L80 B20		MacAdam	SW 2700-3200-4000	SUITABLE		

Z5 14 34 J6

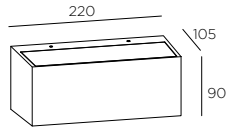

LED	
K	CRI W Total Real Lm Code
SW 2700-3200-4000	80 19.2 1816 05-E027 - Z5 J6 14 - EH ON-OFF 100-240V 34



### Nemesis R7s 70\*170mm

IP	IK	SEA SIDE
44	06	SUITABLE

Z5 14 34 J6

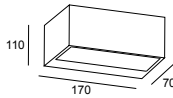
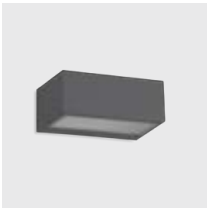

R7s	
W	Code
Max. 100	Z5 J6 14 - B8 05-9177 - 34



### Nemesis E27 90\*220mm

IP	IK	SEA SIDE
54	04	SUITABLE

Z5 14 34 J6

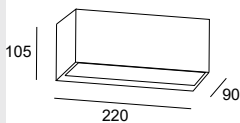

E27	
W	Code
Max. 15	Z5 J6 14 - T2 05-9649 - 34



#### Nemesis LED 170mm



#### Nemesis LED 220mm



#### Nemesis R7s 70\*170mm



#### Nemesis E27 90\*220mm



### Accesorios ópticos

Accessórios óticos



Obturator de luz para pasar de doble emisión a mono emisión  
 Obturator de luz para passar de emissão dupla para mono

-

-

Included

Included

# Wilson

Designed by LedsC4 Architectural



## Un plus de elegancia en todo tipo de paredes Um plus de elegância em todo o tipo de paredes

El limpio diseño de Wilson, ligeramente redondeado y con la tornillería oculta; junto con su haz de luz definido y un sugerente juego de luces y sombras, hacen que esta colección sea muy valorada en proyectos que necesitan un plus de elegancia.

O design limpo da Wilson, ligeiramente arredondado e com os parafusos ocultos, juntamente com o seu feixe de luz definido e um sugestivo jogo de luzes e sombras, tornam esta coleção altamente valorizada nos projetos que necessitam de um toque extra de elegância.

Cuenta con la posibilidad de cambiar el ángulo de salida de luz según las necesidades del espacio de forma rápida y sencilla.

Tem a possibilidade de alterar o ângulo de saída da luz de acordo com as necessidades do espaço de forma rápida e simples.



# Wilson

BODY MAT	DIF MAT		50000h	3
AL	GLA		L80 B20	MacAdam

## Wilson Square

IP	IK	BREEAM	SEA SIDE SUITABLE		
65	08				

● ○ ●  
Z5 14 J6

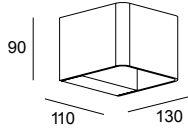
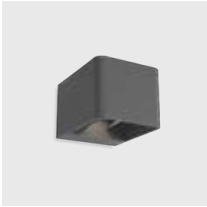

LED						
K	CRI	W Total	Real Lm	Code		
2700	80	10.2	623	<b>05-9683 - Z5 - CK</b>	ON-OFF 100-240V	
<b>Z5</b>						
3000	80	10.2	623	<b>05-9683 - J6 - CL</b>	ON-OFF 100-240V	
<b>14</b>						

## Wilson Rectangular

IP	IK	SEA SIDE SUITABLE		
65	08			

●  
Z5

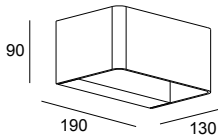

LED						
K	CRI	W Total	Real Lm	Code		
3000	80	20.7	916	<b>05-9684 - Z5 - CL</b>	ON-OFF 100-240V	



# Clous

Designed by LedsC4 Architectural

BODY MAT	DIF MAT		50000h	3
AL	GLA		L80 B20	MacAdam

## Ideal para decoración de fachadas

## Ideal para decoração de fachadas

Con muy poca profundidad, estos apliques se integran en la arquitectura y pasan fácilmente desapercibidos. Esta colección está concebida para dar personalidad a las fachadas gracias a sus efectos de luz definidos.

Com muito pouca profundidade, estes apliques integram-se na arquitetura e passam facilmente despercebidos. Esta coleção foi concebida para dar personalidade às fachadas graças aos seus efeitos de luz definidos.



## Clous Single Emission

IP	IK	SEA SIDE		
66	03	SUITABLE		

Z5  14

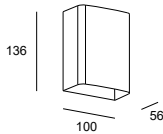

LED									
K	CRI	W Total	Real Lm	Optics	Code				
3000	80	11	537	89°	05-9926 - Z5 - CL	ON-OFF	100-240V	14	

## Clous Double Emission

IP	IK	BREEAM	SEA SIDE
66	03		SUITABLE

Z5  14

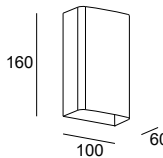

LED									
K	CRI	W Total	Real Lm	Optics	Code				
3000	80	13	758	86°	05-9679 - Z5 - CL	ON-OFF	100-240V	14	

# Simenti

Designed by LedsC4 Architectural

OUTDOOR

## Integración y confort visual Integração e conforto visual

El aplique Up&Down SIMENTI está fabricado 100% en cemento. Con un elevado confort visual, es una opción especialmente utilizada en residencias de alto standing, sobre todo en fachadas de hormigón, para una total integración arquitectónica.

O aplique Up&Down Simenti é fabricado 100% em cimento. Com um elevado nível de conforto visual, é uma opção especialmente utilizada em residências de alto standing, sobretudo em fachadas de betão, para uma integração arquitetónica total.

Disponibile también en versión baliza  
Disponibile también en versión baliza



## Simenti Wall Fixture

IP 66	IK 10	SEA SIDE SUITABLE	LED	DRIVER
----------	----------	----------------------	-----	--------

DC

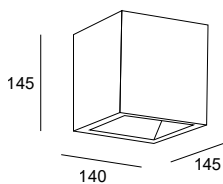

LED						
K	CRI	W Total	Real Lm	Code		
3000	80	10.7	365	05-9971	- DC - CL	ON-OFF 100-240V

APLIQUES | APLIQUES

# Diago

Designed by LedsC4 Architectural

## Discreto y elegante

Discreto e elegante

El aplique Diago tiene un diseño sobrio y un paquete lumínico nada excesivo. Su doble salida de cable facilita la instalación en cadena, pudiéndose instalar en todo el perímetro de la fachada con más facilidad.

O aplique Diago possui um design sóbrio e um pacote lumínico nada excessivo. A sua saída dupla de cabo facilita a instalação em cadeia, podendo ser instalada com mais facilidade em todo o perímetro da fachada.



## Diago Wall Fixture

IP 65	IK 05	BREEAM		SEA SIDE SUITABLE		
----------	----------	--------	--	----------------------	--	--

●  
Z5

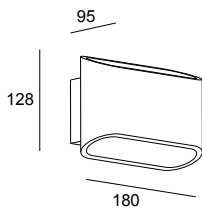

LED						
K	CRI	W Total	Real Lm	Code		
3000	80	9.8	680	<b>05-9873 - Z5 - CL</b>	ON-OFF 100-240V	

# Venus

Designed by LedsC4 Architectural

BODY MAT	DIF MAT		50000h	2
AL	PC		L80 B20	MacAdam

OUTDOOR

## Up&Down con una luz sugerente

### Up&Down com uma luz sugestiva

El aplique Venus va un paso más allá de la clásica iluminación Up&Down decorativa. La base siempre en blanco, junto al diseño interior vacío y el frontal de menor tamaño, iluminan suavemente hacia adelante mediante una cálida luz indirecta que perfecta para dar un toque sugerente en cualquier fachada.

O aplique Venus vai um passo para lá da clássica iluminação Up&Down decorativa. A base branca, juntamente com o design interior vazio e a frente mais pequena, ilumina suavemente para a frente com uma luz quente e indireta que é perfeita para dar um toque sugestivo a qualquer fachada.



# Venus

## Wall Fixture

IP	IK	LOW	SEA SIDE		
65	08	FLICKER	SUITABLE		

● ○  
Z5 14

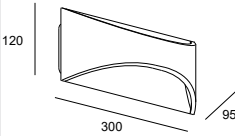

LED						
K	CRI	W Total	Real Lm	Code		
3000	80	11	465	05-9894 - Z5 14 - CL		ON-OFF 100-240V

APLIQUES | APLIQUES

# Finestra

Designed by LedsC4 Architectural



+ Finestra

## Fachadas espectaculares con personalidad propia

## Fachadas espetaculares com personalidade própria

Finestra ilumina las fachadas de efectos de luz espectaculares, que tienen muchas posibilidades gracias a la combinación de diferentes filtros y a su opción de control por DMX.

Finestra ilumina as fachadas com espetaculares efeitos de luz, que têm muitas possibilidades graças à combinação de diferentes filtros e à opção de controlo por DMX.



STANDARD

RGBW DMX RDM



14

34

DL

E3

J6

Z5

60

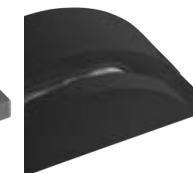
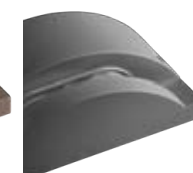
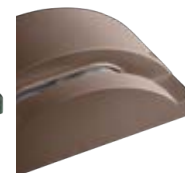
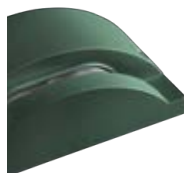
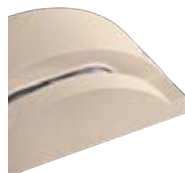



La versión Standard cuenta con filtros de color intercambiables azul, verde, rojo y amarillo.  
A versão Standard possui filtros de cor intercambiáveis azul, verde, vermelho e amarelo.

Su equipamiento está concebido para facilitar el cambio del difusor y regular la inclinación de la luminaria.  
O seu equipamento foi concebido para facilitar a troca do difusor e regular a inclinação da luminária.



# Finestra Standard

BODY MAT
AL

DIF MAT
PC



50000h
L80 B20

3
MacAdam

## La opción más asequible A opção mais acessível

Máxima versatilidad gracias a los filtros incluidos 3000K, amarillo, rojo, azul y verde.

Máxima versatilidade graças aos filtros incluídos 3000K, amarelo, vermelho, azul e verde.

## Finestra Standard

IK
10

⊙
1.5 m

SEA SIDE
SUITABLE

Z5\* 14\* 60\* 34 J6\* E3\* DL\*

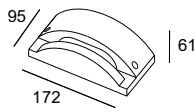

LED

K	CRI	W Total	Real Lm	Optics	Code
---	-----	---------	---------	--------	------

					<b>Z5</b>
					<b>J6</b>
					<b>E3</b>
4000	80	5.4	281	56°	<b>10-9903 - DL - CM</b>
					<b>ON-OFF 100-240V</b>
					<b>14</b>
					<b>60</b>
					<b>34</b>

# Finestra DMX

## La opción avanzada, para un control total A opção avançada, para um controlo total

Con el sistema profesional DMX RDM se ahorra tiempo de instalación porque la asignación de la dirección DMX a cada luminaria se hace cómodamente desde el ordenador mediante un software gratuito. Con esta aplicación se abren posibilidades de combinación y opciones de iluminación infinitas. Además incluye un filtro difusor que permite difuminar el efecto de luz.

O sistema profissional DMX RDM poupa tempo de instalação porque a atribuição do endereço DMX a cada luminária é feita comodamente desde o computador, utilizando um software gratuito. Esta aplicação abre possibilidades de combinação e opções de iluminação infinitas. Inclui também um filtro difusor que permite difundir o efeito de luz.



# Finestra RGBW DMX

IP	IK	LOW		SEA SIDE	LED	DRIVER	SC
66	10	FLICKER		SUITABLE			

Z5\* 14\* 60\* 34 J6\* E3\* DL\*

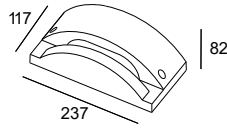
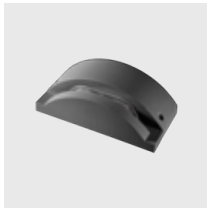

LED							
K	CRI	W Total	Real Lm	Optics	Code		
RGB-4000	80	10.8	414	44°	10-E077	Z5	
						J6	
						E3	
						- DL - 00	DMX 100-277V
						14	
						60	
						34	

## Finestra Standard

## Finestra RGBW DMX



### Controladores

P. 1166



Falta info driver

71-A238-00-00

### Accesorios ópticos



Difusores de colores  
Difusores de cores

Included

-



Filtro difusor  
Filtro difusor

-

Included



Difusor 3000K  
Difusor 3000K

Included

-

### Accesorios de conexión



Conector anticondensación IP68 (1 entrada + 1 salida) Ø 5,5 - 12mm, 4 polos  
Conetor anticondensação IP68 (1 entrada + 1 saída) Ø 5,5 - 12 mm, 4 polos

71-E112-00-00

-



Conector anticondensación IP68 (1 entrada + 3 salidas) Ø 5,5 - 12mm, 4 polos  
Conetor anticondensação IP68 (1 entrada + 3 saídas) Ø 5,5 - 12 mm, 4 polos

71-E122-00-00

-



Caja de conexión IP68 (1 entrada + 5 salidas) Ø 6,5 - 11mm, 6 polos  
Caixa de ligação IP68 (1 entrada + 5 saídas) Ø 6,5 - 11 mm, 6 polos

71-9199-05-05

-

# Arc

Designed by LedsC4 Architectural



+ Arc



## Ideal para fachadas de cemento

## Ideal para fachadas de cemento

ARC está fabricada íntegramente en cemento, por esta razón se integra fácilmente en la arquitectura.

Arc é fabricada inteiramente em betão, o que facilita a sua integração na arquitetura.

Posibilidad de instalar en superficie o empotrada.

Possibilidade de instalar em superfície ou encastrada.



Alto confort visual

Alto conforto visual

BODY MAT	DIF MAT		50000h	3
AL.CON	GLA		L80 B20	MacAdam

IP 66	IK 10		SEA SIDE SUITABLE		
----------	----------	--	----------------------	--	--

DC

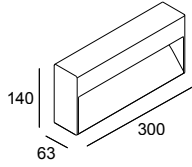

300x140

LED					
K	CRI	W Total	Real Lm	Code	
3000	80	9	404	<b>05-E090 - DC - CL</b>	ON-OFF 230V
4000	80	9	404	<b>05-E090 - DC - CM</b>	ON-OFF 230V

## Accesorios de fijación Acessórios de fixação



Caja de empotrar  
Caixa de encastrar

**71-E090-Z5-00**

# Sam

Designed by Francesc Vilaró



+ Sam

## Elegancia y estilo en un perfil compacto Elegância e estilo num perfil compacto

Sam lo tiene todo para convertirse en un referente de la iluminación de zonas de paso. Se trata de una colección que no hace falta empotrar gracias a su medida compacta pero que incluye driver y unas altísimas prestaciones. Además, su diseño limpio sin tornillería vista, junto a la extensa gama de acabados la convierten en una familia apta tanto para exteriores como para interiores.

Sam tem tudo para se tornar uma referência na iluminação de zonas de passagem. Trata-se de uma coleção que não precisa de ser encastrada graças ao seu tamanho compacto mas que inclui um driver e altíssimas prestações. Além disso, o seu design limpo sem parafusos visíveis, juntamente com a vasta gama de acabamentos convertem-na uma família adequada tanto para exteriores como para interiores.



180 mm



140 mm



14

34

DL

E3

J6

Z5

60





Ilumina la zona de paso con  
precisión y con gran confort visual  
Ilumina a zona de passagem com  
precisão e grande conforto visual

Sam 180 mm

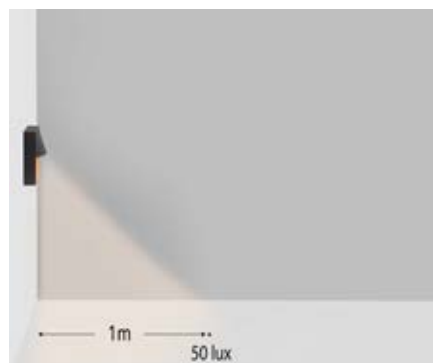
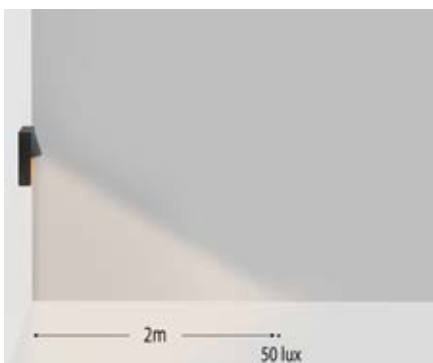
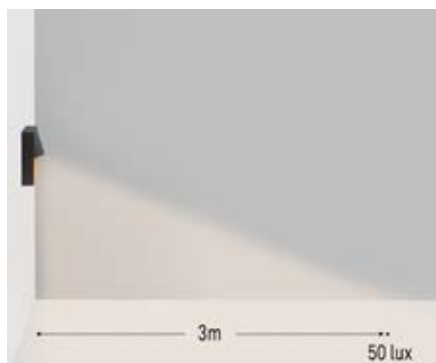

Sam 140 mm

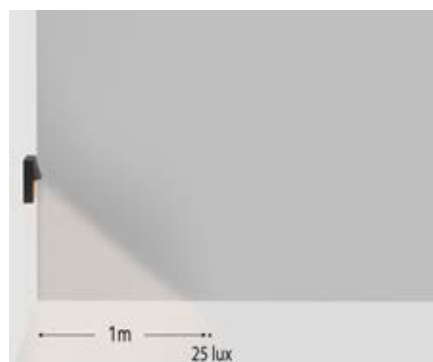
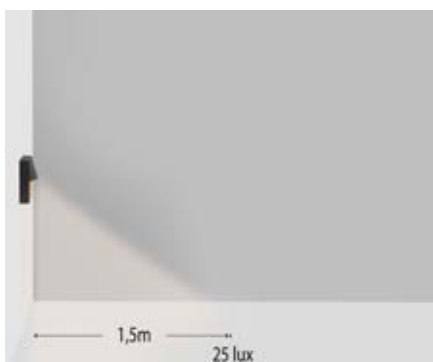
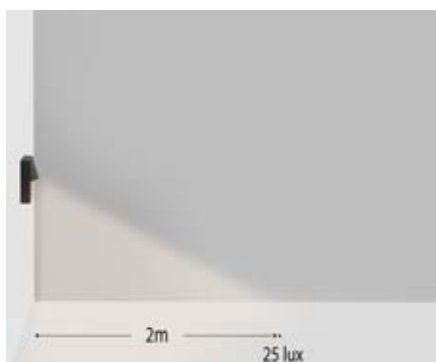

Switch para cambio de  
temperatura de color incluido  
Switch para mudança de  
temperatura de cor incluído

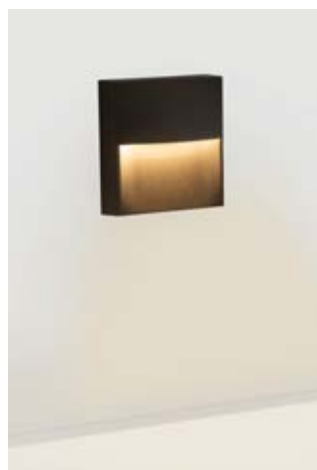



BODY MAT	DIF MAT		50000h	3
AL	PC		L80 B20	MacAdam

## Sam 140mm

IP	IK	SWITCH CCT		SEA SIDE SUITABLE		
66	10	SW 2700-3200-4000				

Z5 14\* 60\* 34\* J6\* E3\* DL\*

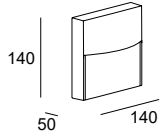

LED									
K	CRI	W Total	Real Lm	Code					
					Z5				
					J6				
					E3				
SW 2700-3200-4000	80	3.5	269	05-E059	- DL - EH	ON-OFF	220-240V		
					14				
					60				
					34				

## Sam 180mm

IP	IK	SWITCH CCT		SEA SIDE SUITABLE		
66	10	SW 2700-3200-4000				

Z5 14\* 60\* 34\* J6\* E3\* DL\*

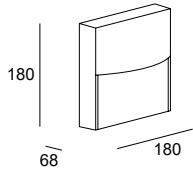

LED									
K	CRI	W Total	Real Lm	Code					
					Z5				
					J6				
					E3				
SW 2700-3200-4000	80	18.5	1458	05-E058	- DL - EH	DALI-2	120-277V		
				05-E068	- DL - EH	ON-OFF	100-240V		
					14				
					60				
					34				





## Un falso empotrado con muchas opciones Um falso encastrado com muitas opções

Kössel ilumina suavemente las zonas de paso. Su poca profundidad parecería indicar que se trata de un empotrado de pared, pero no sólo es de superficie sino que también se presenta con driver incluido, lo que facilita y economiza su instalación.

Kössel ilumina suavemente as zonas de passagem. A sua pouca profundidade parece indicar que se trata de um encastrado de parede, mas não só é de superfície como também se apresenta com driver incluído, o que torna a sua instalação fácil e económica.

### Kössel Indirect



### Kössel Direct



# Kössel

## Wall Fixture Direct

BODY MAT PC+ABS	DIF MAT PC		50000h L80 B20	3 MacAdam
--------------------	---------------	--	-------------------	--------------

IP 65	IK 10	BREEAM		SEA SIDE SUITABLE	LED	DRIVER
----------	----------	--------	--	----------------------	-----	--------

34

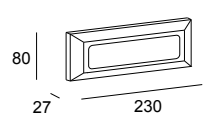

LED						
K	CRI	W Total	Real Lm	Code		
3000	80	3.8	238	<b>05-9779 - 34 - CL</b>	ON-OFF 100-240V	
4000	80	3.8	262	<b>05-9779 - 34 - CM</b>	ON-OFF 100-240V	

### Accesorios de fijación Acessórios de fixação

	Frontal blanco Frontal branco	Included
	Frontal gris claro Frontal cinza claro	Included
	Frontal gris Frontal cinzento	Included

# Kössel

## Wall Fixture Indirect

BODY MAT	DIF MAT		50000h	3
PC+ABS	PC		L80 B20	MacAdam

### Kössel Indirect Square 125mm

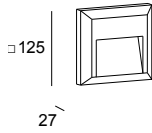

IP	IK	SEA SIDE SUITABLE		
65	10			

○  
14





LED						
K	CRI	W Total	Real Lm	Code		
4000	80	1.5	65	<b>05-9802 - 14 - CM</b>	ON-OFF 100-240V	

### Kössel Indirect Square 200mm

IP	IK	LOW FLICKER		SEA SIDE SUITABLE		
66	10					

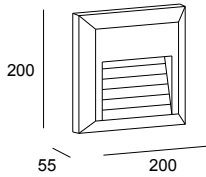
○  
14



LED						
K	CRI	W Total	Real Lm	Code		
4000	80	7	295	<b>05-E069 - 14 - CM</b>	ON-OFF 220-240V	

### Kössel Indirect Rectangular

IP	IK		SEA SIDE SUITABLE		
65	10				

○  
14

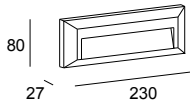



LED						
K	CRI	W Total	Real Lm	Code		
4000	80	2.4	91	<b>05-9814 - 14 - CM</b>	ON-OFF 100-240V	

Kössel Indirect  
Square 125mmKössel Indirect  
Square 200mmKössel Indirect  
Rectangular
**Accesorios ópticos**  
 Acessórios óticos

 Difusor 3000K Difusor 3000K	Included	Included	Included
------------------------------------------------------------------------------------------------------------------	----------	----------	----------

**Accesorios de fijación**  
 Acessórios de fixação

 Frontal blanco Frontal branco	Included	Included	Included
 Frontal gris claro Frontal cinza claro	Included	Included	Included
 Frontal gris Frontal cinzento	Included	Included	Included

# CUBUS

BODY MAT	DIF MAT		50000h	3
AL	GLA		L80 B20	MacAdam

## Rotación útil para iluminar zonas oscuras

### Rotação útil para iluminar zonas escuras

Colección que cuenta con un cabezal giratorio ideal para iluminar zonas de complicado acceso para otros apliques convencionales. Cubus es especialmente útil cuando la toma de corriente está alejada de lo que queremos iluminar.

Coleção que possui uma cabeça rotativa ideal para iluminar zonas de difícil acesso para outros apliques convencionais. Cubus é especialmente útil quando a tomada está longe do que queremos iluminar.

## Cubus

### Wall Fixture

IP 65	IK 04	BREEAM	SEA SIDE SUITABLE	 ±45°		
----------	----------	--------	----------------------	------------------------------------------------------------------------------------------	-------------------------------------------------------------------------------------	-------------------------------------------------------------------------------------

●  
Z5

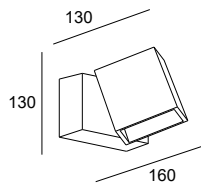

LED							
K	CRI	W	Total	Real	Lm	Optics	Code
3000	80	13	701	71°		05-9685 - Z5 - CL	ON-OFF 100-240V

# Darwin

BODY MAT  
PC

DIF MAT  
PC



OUTDOOR

Colección esencial con dos posibilidades de instalación, una recta, perpendicular a la pared y otra ligeramente inclinada hacia delante. De forma geométrica, su forma abombada y su efecto de luz aporta personalidad al espacio. Colección esencial con dos posibilidades de instalación, una recta, perpendicular a la pared y otra ligeramente inclinada hacia delante. De forma geométrica, su forma abombada y su efecto de luz aporta personalidad al espacio.

Coleção essencial com duas possibilidades de instalação, uma reta, perpendicular à parede e outra ligeiramente inclinada para a frente. De forma geométrica, a sua forma abaulada e o seu efeito de luz dão personalidade ao espaço.



IP  
54

IK  
10

SEA SIDE  
SUITABLE

Z5

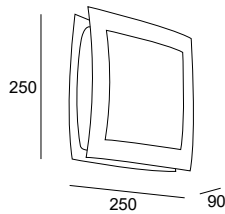
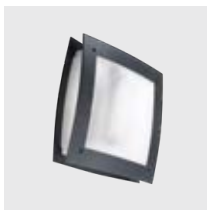

E27

**W**  
Max. 15

**Code**

**05-9444 - Z5 - CD**

APLIQUES | APLIQUES

# Skat

Designed by LedsC4 Architectural



+ Skat

## Elegante luz directa Elegante luz direta

Skat es una colección de apliques de iluminación directa, de diseño atemporal y uso versátil. Se presenta en tres medidas y puede personalizarse con los colores ofrecidos por LedsC4. Esta luminaria proyecta una luz homogénea, e incluye tecnología CCT.

Skat é uma coleção de apliques de iluminação direta, de design intemporal e uso versátil. Apresenta-se em três medidas e pode ser personalizada com as cores oferecidas pela LedsC4. Esta luminária projeta uma luz homogénea, e inclui tecnologia CCT.



14

34

DL

E3

J6

Z5

60







Switch CCT incluido  
Switch CCT incluido



2700K



3200K



4000K



BODY MAT	DIF MAT		50000h	3
AL	PC		L80 B20	MacAdam

## Skat 200mm

IP	IK	BREEAM	SWITCH CCT	SEA SIDE	LED	DRIVER
65	10		SW 2700-3200-4000	SUITABLE		

Z5 14\* 60\* 34\* J6\* E3\* DL\*

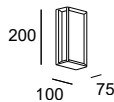
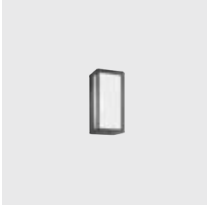

LED						
K	CRI	W Total	Real Lm	Code		
					Z5	
					J6	
					E3	
SW 2700-3200-4000	80	10	602	05-E028	- DL - EH	ON-OFF 100-240V
					14	
					60	
					34	

## Skat 350mm

IP	IK	LOW	BREEAM	SWITCH CCT		SEA SIDE	LED	DRIVER
65	10	FLICKER		SW 2700-3200-4000		SUITABLE		

Z5 14\* 60\* 34\* J6\* E3\* DL\*

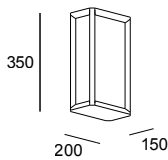

LED						
K	CRI	W Total	Real Lm	Code		
					Z5	
					J6	
					E3	
SW 2700-3200-4000	80	23.9	1266	05-E055	- DL - EH	ON-OFF 100-240V
					14	
					60	
					34	

## Skat 500mm

IP	IK	LOW	BREEAM	SWITCH CCT		SEA SIDE	LED	DRIVER
65	10	FLICKER		SW 2700-3200-4000		SUITABLE		

Z5 14\* 60\* 34\* J6\* E3\* DL\*

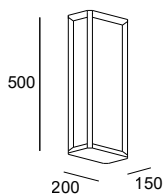

LED						
K	CRI	W Total	Real Lm	Code		
					Z5	
					J6	
					E3	
SW 2700-3200-4000	80	23.9	1266	05-E109	- DL - EH	ON-OFF 100-240V
					14	
					60	
					34	

# Rack

Designed by LedsC4 Architectural



+ Rack

## Versátil y adaptable al espacio

## Versátil e adaptável ao espaço

No es fácil encontrar luminarias decorativas con altas prestaciones, como IP66, regulación DALI, eficiencia BREEAM o tratamiento contra la atmósfera marina. Rack ha sido minuciosamente desarrollada para aquellos proyectos donde iluminar y decorar con personalidad no es suficiente, sino que la fiabilidad es un factor igual o incluso más importante.

Não é fácil encontrar luminárias decorativas com alto desempenho, como IP66, regulação DALI, eficiência BREEAM ou tratamento contra a atmosfera marinha. Rack foi cuidadosamente desenvolvida para aqueles projetos em que a iluminação e a decoração com personalidade não é suficiente, sendo a fiabilidade um fator igualmente ou ainda mais importante.



14

34

DL

E3

J6

Z5

60



# Rack Wall Fixture

BODY MAT	DIF MAT		50000h	3
AL.CON	GLA		L80 B20	MacAdam

## Rack Wall Fixture 150x150x160mm

IP	IK	BREEAM	SWITCH CCT		SEA SIDE	LED	DRIVER
66	06		SW 2700-3200-4000	2 m	SUITABLE		

Z5\* 14\* 60 34\* J6\* E3\* DL\*

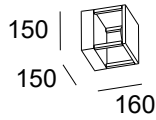

LED							
K	CRI	W	Total	Real	Lm	Code	
SW 2700-3200-4000	80	14.9	760			Z5	
						J6	
				05-E071	E3	OU	ON-OFF 100-277V
				05-E076	- DL	- DU	DALI-2 100-277V
				05-E077	14	XB	CASAMBI 220-240V
						60	
						34	

## Rack Wall Fixture 150x150x300mm

IP	IK	BREEAM	SWITCH CCT		SEA SIDE	LED	DRIVER
66	06		SW 2700-3200-4000	2 m	SUITABLE		

Z5\* 14\* 60 34\* J6\* E3\* DL\*

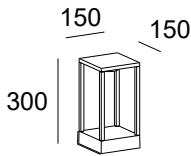

LED							
K	CRI	W	Total	Real	Lm	Code	
SW 2700-3200-4000	80	14.9	760			Z5	
						J6	
				05-E082	E3	OU	ON-OFF 100-277V
				05-E088	- DL	- DU	DALI-2 100-277V
				05-E089	14	XB	CASAMBI 220-240V
						60	
						34	

Rack Wall Fixture  
150×150×160mmRack Wall Fixture  
150×150×300mm

### Accesorios ópticos

#### Acessórios óticos



Difusor esférico de cristal opal  
Difusor esférico de vidro opalino

-

**71-E284-60-F9**

### Accesorios de conexión

#### Acessórios de conexão



Conector IP68 (1 entrada + 1 salida) Ø 6 - 17mm, 5 polos  
Conetor IP68 (1 entrada + 1 saída) Ø 6 - 17 mm, 5 polos

**71-E361-00-00****71-E361-00-00**

Conector anticondensación IP68 (1 entrada + 1 salida) Ø 5,5 - 12mm, 4 polos  
Conetor anticondensação IP68 (1 entrada + 1 saída) Ø 5,5 - 12 mm, 4 polos

**71-E112-00-00****71-E112-00-00**

Conector anticondensación IP68 (1 entrada + 3 salidas) Ø 5,5 - 12mm, 4 polos  
Conetor anticondensação IP68 (1 entrada + 3 saídas) Ø 5,5 - 12 mm, 4 polos

**71-E122-00-00****71-E122-00-00**

Caja de conexión IP68 (1 entrada + 5 salidas) Ø 6,5 - 11mm, 6 polos  
Caixa de ligação IP68 (1 entrada + 5 saídas) Ø 6,5 - 11 mm, 6 polos

**71-9199-05-05****71-9199-05-05**

### Accesorios decorativos

#### Acessórios decorativos



Set rejillas decorativas (4u.)  
Set grelhas decorativas (4u.)

60 ●

**71-E278-60-00****71-E279-60-00**

Z5 ● \*

**71-E278-Z5-00****71-E279-Z5-00**

J6 ● \*

**71-E278-J6-00****71-E279-J6-00**

E3 ● \*

**71-E278-E3-00****71-E279-E3-00**

DL ● \*

**71-E278-DL-00****71-E279-DL-00**

14 ○ \*

**71-E278-14-00****71-E279-14-00**

34 ○ \*

**71-E278-34-00****71-E279-34-00**

## Curie Glass LED Small

IP	IK	BREEAM	50000h	3	SWITCH CCT	SEA SIDE	LED	DRIVER
65	05		L80 B20	MacAdam	SW 2700-3200-4000	SUITABLE		

Z5 14\* 60\* 34\* J6\* E3\* DL\*

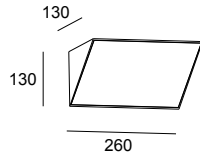

LED					
K	CRI	W	Real Lm	Code	
SW 2700-3200-4000	80	12.4	792	<b>05-E139</b>	<b>- DL - EH</b>
				<b>Z5</b>	
				<b>J6</b>	
				<b>E3</b>	
				<b>14</b>	
				<b>60</b>	
				<b>34</b>	

## Curie Glass LED Big

IP	IK	BREEAM	50000h	3	SWITCH CCT	SEA SIDE	LED	DRIVER
65	05		L80 B20	MacAdam	SW 2700-3200-4000	SUITABLE		

Z5 14\* 60\* 34\* J6\* E3\* DL\*

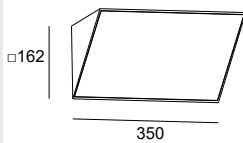
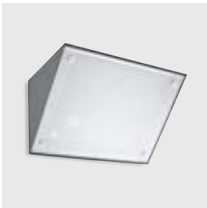

LED					
K	CRI	W	Real Lm	Code	
SW 2700-3200-4000	80	25.1	2941	<b>05-E140</b>	<b>- DL - EH</b>
				<b>Z5</b>	
				<b>J6</b>	
				<b>E3</b>	
				<b>14</b>	
				<b>60</b>	
				<b>34</b>	

## Curie Glass E27 Small

IP	IK	SEA SIDE
65	05	SUITABLE

Z5 14\* 60\* 34\* J6\* E3\* DL\*

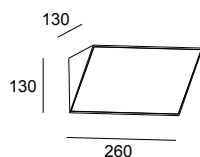

E27	
W	Code
Max. 15	<b>05-9884 - DL - G5</b>
	<b>Z5</b>
	<b>J6</b>
	<b>E3</b>
	<b>14</b>
	<b>60</b>
	<b>34</b>



Curie Glass E27 Big

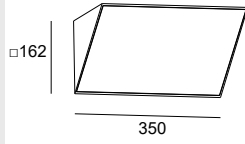
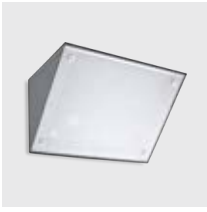

IP	IK		SEA SIDE SUITABLE
65	05		

● ○ ● ● ● ● ● ●  
Z5 14\* 60\* 34\* J6\* E3\* DL\*



E27	
<b>W</b>	<b>Code</b>
2 × Max. 15	<b>Z5</b>
	<b>J6</b>
	<b>E3</b>
	<b>05-9993 - DL - G5</b>
	<b>14</b>
	<b>60</b>
	<b>34</b>

Curie PC LED Small

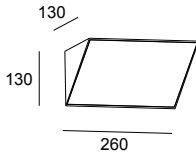

IP	IK	50000h	BREEAM	3	SWITCH CCT	SEA SIDE SUITABLE		
65	10	L80 B20		MacAdam	SW 2700-3200-4000			

● ○ ● ● ● ● ● ●  
Z5 14\* 60\* 34\* J6\* E3\* DL\*



LED					
K	CRI	W	Real Lm	Code	
SW 2700-3200-4000	80	12.4	792	<b>05-E137</b>	<b>- DL - EH</b>
				<b>Z5</b>	
				<b>J6</b>	
				<b>E3</b>	
				<b>14</b>	
				<b>60</b>	
				<b>34</b>	

Curie PC LED Big

IP	IK	50000h	BREEAM	3	SWITCH CCT		SEA SIDE SUITABLE		
65	10	L80 B20		MacAdam	SW 2700-3200-4000				

● ○ ● ● ● ● ● ●  
Z5 14\* 60\* 34\* J6\* E3\* DL\*

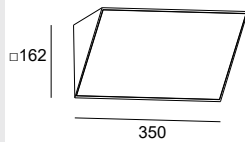
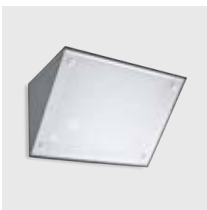

LED					
K	CRI	W	Real Lm	Code	
SW 2700-3200-4000	80	25.1	2941	<b>05-E138</b>	<b>- DL - EH</b>
				<b>Z5</b>	
				<b>J6</b>	
				<b>E3</b>	
				<b>14</b>	
				<b>60</b>	
				<b>34</b>	

## Curie PC E27 Small

IP	IK	BREEAM	50000h	3	SWITCH CCT	SEA SIDE SUITABLE
65	10		L80 B20	MacAdam	SW 2700-3200-4000	

  
 Z5 14\* 60\* 34\* J6\* E3\* DL\*

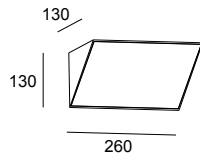
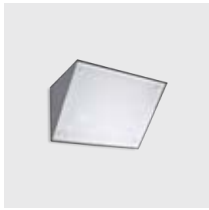

E27	
<b>W</b>	<b>Code</b>
	Z5
	J6
	E3
Max. 15	<b>05-E144 - DL - M1</b>
	14
	60
	34

OUTDOOR

## Curie PC E27 Big

IP	IK	50000h	BREEAM	3	SWITCH CCT	SEA SIDE SUITABLE
65	10	L80 B20		MacAdam	SW 2700-3200-4000	

  
 Z5 14\* 60\* 34\* J6\* E3\* DL\*

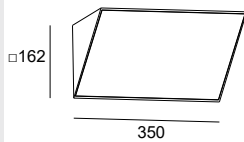
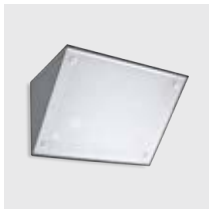

E27	
<b>W</b>	<b>Code</b>
	Z5
	J6
	E3
Max. 15	<b>05-E145 - DL - M1</b>
	14
	60
	34

APLIQUES | APLIQUES

# Basic

Designed by LedsC4 Architectural



+ Basic



## Robusta y asequible Robusta e acessível

BASIC es una colección esencial que se ha actualizado y mejorado para soportar cualquier uso profesional intensivo. Su iluminación general mediante luz directa aporta un plus de calidad al espacio.

Basic é uma coleção essencial que foi atualizada e melhorada para suportar qualquer uso profissional intensivo. A sua iluminação geral mediante luz direta dá um plus de qualidade do espaço.



14

34

DL

E3

J6

Z5

60





Switch CCT integrado que permite cambiar la temperatura de color según necesidad del espacio.  
Switch CCT integrado que permite alterar a temperatura da cor de acordo com as necessidades do espaço.

2700K



3200K



4000K



Uniformidad, confort y  
eficiencia >80 lm/W del difusor  
Uniformidade, conforto e  
eficiência >80Lm/W. do difusor

Fabricado con policarbonato transparente de alta calidad mezclado con un aditivo técnico esparcido con un método de calor y secado por inyección.

Fabricado com policarbonato transparente de alta qualidade misturado com um aditivo técnico espalhado com a técnica de calor e secagem por injeção.

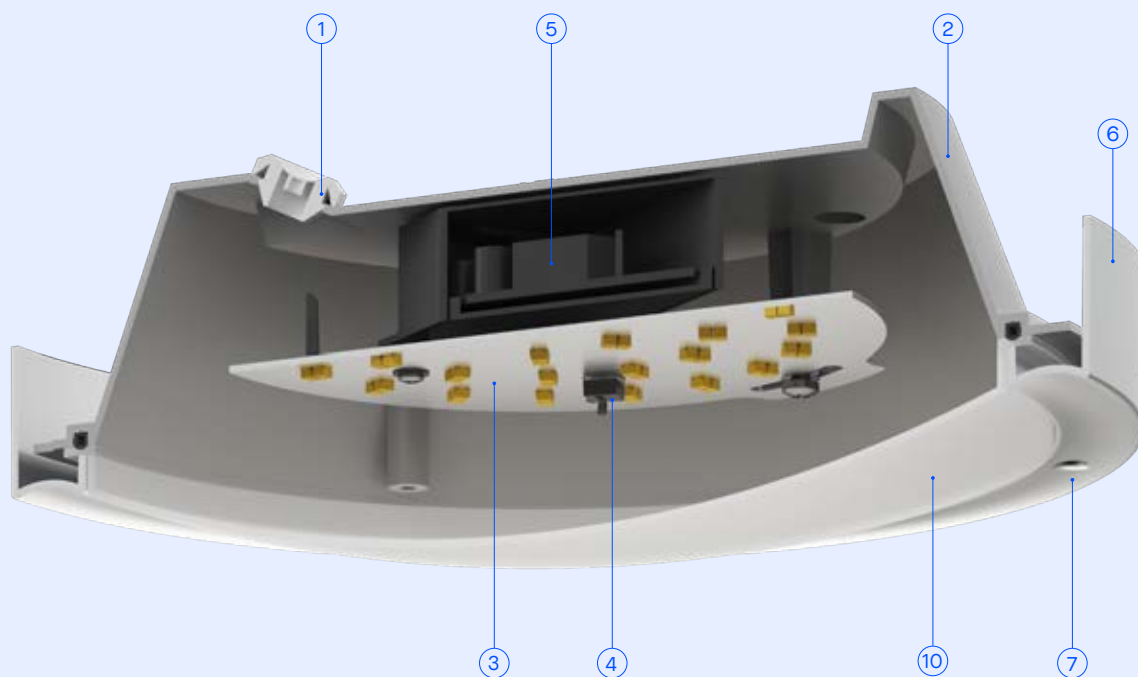

① Prensaestopas IP66 para máxima protección. Bucins IP66 para máxima proteção.

② Base de tecnopolímero resistente a la humedad. Base de tecnopolímero para uma maior resistência à humidade.

③ Disipador de aluminio. Dissipador de alumínio para garantir 50.000h L80 B20.

④ Switch CCT. 2700K, 3200K y 4000K. Switch CCT. 2700K, 3200K e 4000K.

⑤ Equipo incluido. Equipamento incluído.

⑥ Cuerpo robusto de aluminio y con tratamiento antióxido. Corpo de alumínio para maior robustez e com tratamento antiferrugem.

⑦ Tornillería acero inoxidable AISI316. Parafusos aço inoxidável AISI316.

⑧ Difusor de policarbonato IK10. Difusor de policarbonato IK10.

## Basic Wall Fixture Oval LED

IP	IK		50000h	3	SWITCH CCT	<a href="#">SEA SIDE</a> <a href="#">SUITABLE</a>		
66	10		L80 B20	MacAdam	SW 2700-3200-4000			

Z5 14\* 60\* 34\* J6\* E3\* DL\*

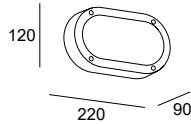

LED								
K	CRI	W Total	Real Lm	Code				
					Z5			
					J6			
					E3			
SW 2700-3200-4000	80	8.5	721	05-E102	- DL - EH	ON-OFF	220-240V	
					14			
					60			
					34			

## Basic 260mm LED

IP	IK	UGR		BREEAM	50000h	3	SWITCH CCT	<a href="#">SEA SIDE</a> <a href="#">SUITABLE</a>	
66	10	<22		L80 B20	MacAdam	SW 2700-3200-4000			



Z5 14\* 60\* 34\* J6\* E3\* DL\*

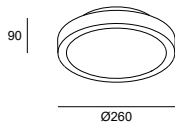

LED								
K	CRI	W Total	Real Lm	Code				
					Z5			
					J6			
					E3			
SW 2700-3200-4000	80	13.5	1269	15-E049	- DL - EH	ON-OFF	220-240V	
					14			
					60			
					34			

## Basic 360mm LED

IP	IK	UGR	LOW		BREEAM	50000h	3	SWITCH CCT	<a href="#">SEA SIDE</a> <a href="#">SUITABLE</a>
66	10	<22	FLICKER		L80 B20	MacAdam	SW 2700-3200-4000		



Z5 14\* 60\* 34\* J6\* E3\* DL\*

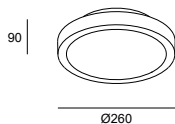

LED								
K	CRI	W Total	Real Lm	Code				
					Z5			
					J6			
					E3			
SW 2700-3200-4000	80	24	2500	15-E050	- DL - EH	ON-OFF	220-240V	
					14			
					60			
					34			

**Basic Wall Fixture Oval E27**

IP	IK		SEA SIDE SUITABLE
66	10		

  
 Z5 14\* 60\* 34\* J6\* E3\* DL\*

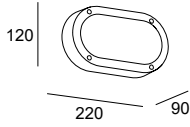

E27	
<b>W</b>	<b>Code</b>
Max. 15	Z5
	J6
	E3
	05-9886 - DL - M1
	14
	60
	34

**Basic 260mm E27**

IP	IK		SEA SIDE SUITABLE
66	10		

  
 Z5 14\* 60\* 34\* J6\* E3\* DL\*

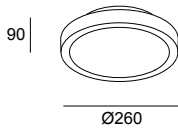

E27	
<b>W</b>	<b>Code</b>
Max. 15	Z5
	J6
	E3
	15-9835 - DL - M1
	14
	60
	34

**Basic 360mm E27**

IP	IK		SEA SIDE SUITABLE
66	10		

  
 Z5 14\* 60\* 34\* J6\* E3\* DL\*

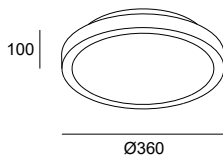

E27	
<b>W</b>	<b>Code</b>
2 × Max. 15	Z5
	J6
	E3
	15-E041 - DL - M1
	14
	60
	34





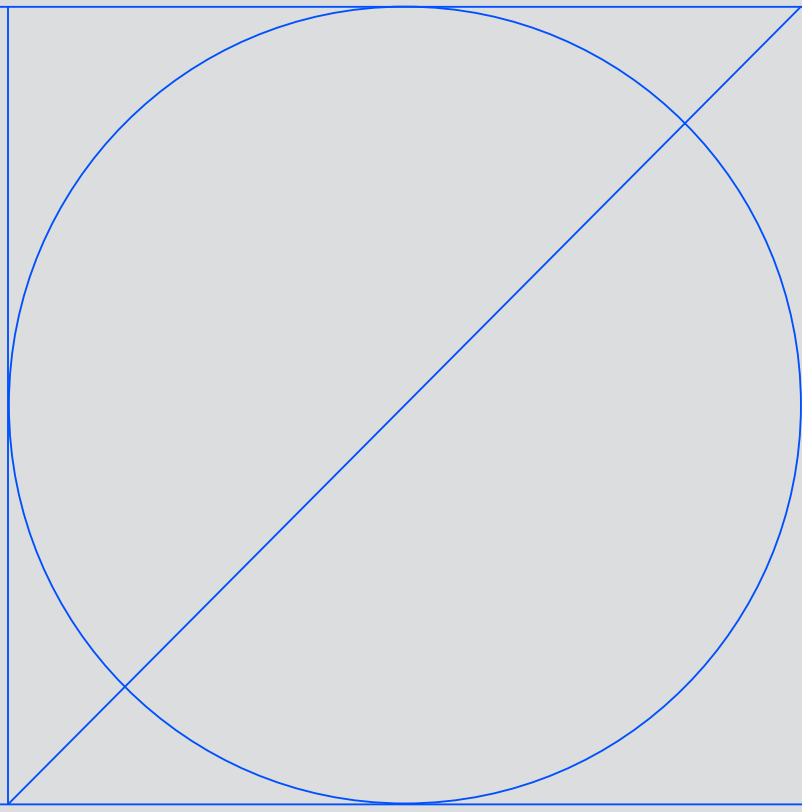

# Plafones Plafons

Max

924



Cosmos

928

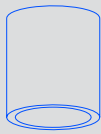

Modis

932

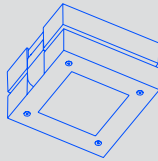

Bento IP

938

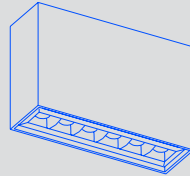

Mega

940

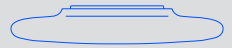

Afrodita

942

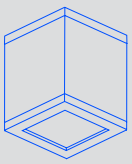

Kössel

943

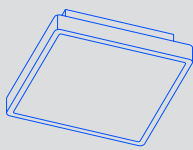

Solid

944

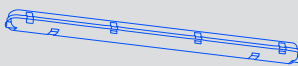

# Max

Designed by LedsC4 Architectural



+ Max

**FAMILIA / FAMILIA:** Downlights, Uplights, Spotlights, Wall Fixtures



## Lo mejor del diseño interior aplicado al exterior O melhor do design interior aplicado ao exterior

Los plafones Max son especialmente adecuados para proyectos donde necesitamos una única familia de luminarias tanto para el interior como para el exterior. Gracias a su diseño con tornillería oculta, su extensa gama de opciones y sus altas prestaciones, se adapta con facilidad a los proyectos más exigentes. Os plafons Max são particularmente adequados para projetos em que é necessária uma única família de luminárias tanto para o interior como para o exterior. Graças ao seu design com parafusos ocultos, a sua extensa gama de opções e o seu elevado desempenho, adapta-se com facilidade aos projetos mais exigentes.



14



34



DL



E3



J6



Z5



60





# Max Ceiling

BODY MAT	DIF MAT		50000h	3
AL	GLA		L80 B20	MacAdam

# Max Medium Ceiling

IP	IK	UGR	BREEAM	SEA SIDE SUITABLE	LED	DRIVER
66	10	<16				

Ejemplo de código / Exemplo de código: **AI22-P3V9S10SZ5**

Model	W	K / CRI/ Real lm	Optics	Source	Finishes
 160 Ø58	<b>P3</b> 4.2W	<b>V9</b> 2700K / CRI90 / 257 lm	<b>S1</b> 9°	<b>OS</b> ON-OFF 220-240V	<b>Z5</b>
		<b>W9</b> 3000K / CRI90 / 257 lm			<b>14*</b>
		<b>X9</b> 4000K / CRI90 / 257 lm			<b>34*</b>
	<b>P6</b> 6.5W	<b>V9</b> 2700K / CRI90 / 456 lm	<b>S2</b> 17°	<b>OS</b> ON-OFF 220-240V	<b>60*</b>
		<b>W9</b> 3000K / CRI90 / 403 lm			<b>DL*</b>
		<b>X9</b> 4000K / CRI90 / 372 lm			<b>E3*</b>
			<b>F1</b> 50°		<b>J6*</b>

# Max Medium Ceiling Dimming

IP	IK	UGR	SEA SIDE SUITABLE	LED	DRIVER
66	10	<19			

Ejemplo de código / Exemplo de código: **AI25-P6V9S1DUZ5**

Model	W	K / CRI/ Real lm	Optics	Source	Finishes
 251 Ø58	<b>P6</b> 8W	<b>V9</b> 2700K / CRI90 / 373 lm	<b>S1</b> 9°	<b>DU</b> DALI-2 100-277V	<b>Z5</b>
		<b>W9</b> 3000K / CRI90 / 373 lm		<b>XB</b> CASAMBI 220-240V	<b>14*</b>
		<b>X9</b> 4000K / CRI90 / 373 lm			<b>34*</b>
	<b>P8</b> 10.4W	<b>V9</b> 2700K / CRI90 / 610 lm	<b>M2</b> 17°	<b>DU</b> DALI-2 100-277V	<b>60*</b>
		<b>W9</b> 3000K / CRI90 / 540 lm		<b>XB</b> CASAMBI 220-240V	<b>DL*</b>
		<b>X9</b> 4000K / CRI90 / 498 lm		<b>S2</b> 50°	<b>E3*</b>
					<b>J6*</b>

\* Consulte condiciones y plazos de entrega a nuestro equipo comercial.  
 \* Consultar a nossa equipa comercial para informações sobre as condições e os prazos de entrega.

# Max Big Ceiling

IP 66	IK 10	UGR <19	BREEAM		SEA SIDE SUITABLE	LED	DRIVER
----------	----------	------------	--------	--	----------------------	-----	--------

Ejemplo de código / Exemplo de código: **AT22-18V9S30SZ5**

Model	W	K / CRI/ Real lm	Optics	Source	Finishes
 	<b>18</b> 19.7W	<b>V9</b> 2700K / CRI90 / 1985 lm	<b>S3</b> 21°	<b>OS</b> ON-OFF 220-240	<b>Z5</b>
		<b>W9</b> 3000K / CRI90 / 2047 lm	<b>M3</b> 31°	<b>DU</b> DALI-2 100-277V	<b>14*</b>
		<b>X9</b> 4000K / CRI90 / 1803 lm	<b>F1</b> 40°	<b>XB</b> CASAMBI 220-240V	<b>34*</b>
					<b>60*</b>
					<b>DL*</b>
					<b>E3*</b>
					<b>J6*</b>

## Max Medium Ceiling



## Max Medium Ceiling Dimming



## Max Big Ceiling



## Accesorios ópticos Acessórios óticos

	Difusor wall washer (5u.) Wall washer diffuser (5u.)	<b>71-E463-00-00</b>	<b>71-E463-00-00</b>	<b>71-E464-00-00</b>
	Panel de abeja (5u.) Painel de abelha (5u.)	<b>71-E131-00-00</b>	<b>71-E131-00-00</b>	<b>71-E263-00-00</b>
	Difusor cuadrado (5u.) Difusor quadrado (5u.)	<b>71-E135-00-00</b>	<b>71-E135-00-00</b>	<b>71-E262-00-00</b>
	Difusor elíptico (5u.) Difusor elíptico (5u.)	<b>71-E141-00-00</b>	<b>71-E141-00-00</b>	<b>71-E261-00-00</b>
	Difusor opal (5u.) Difusor opal (5u.)	<b>71-E133-00-00</b>	<b>71-E133-00-00</b>	<b>71-E260-00-00</b>

\* Consulte condiciones y plazos de entrega a nuestro equipo comercial.

\* Consultar a nossa equipa comercial para informações sobre as condições e os prazos de entrega.



# Cosmos



+ Cosmos



## Compacta y elegante Compacta e elegante

La colección Cosmos es funcional, técnica y decorativa a partes iguales. Su diseño, compacto y elegante, es ideal para la iluminación de hoteles, áreas públicas y residencias con un marcado buen gusto.

A coleção Cosmos é funcional, técnica e decorativa em igual medida. O seu design compacto e elegante é ideal para a iluminação de hotéis, áreas públicas e residências com um marcado bom gosto.

Decoreflector plateado  
Decorrefletor prateado



Decoreflector dorado  
Decorrefletor dourado



14



34



DL



E3



J6



Z5



60





Son Rich Residences, Begur.  
Son Rich Residences, Begur.

# Cosmos Ceiling

BODY MAT	DIF MAT		50000h	2
AL	GLA		L80 B20	MacAdam

## Cosmos Ceiling 90mm

IP	IK	BREEAM	SEA SIDE SUITABLE	LED	DRIVER
65	08				

Z5 14\* 60\* 34\* J6\* E3\* DL\*

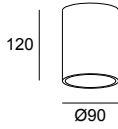

LED											
K	CRI	W Total	Real Lm	Optics	Code						
						Z5					
						J6					
						E3					
3000	80	9.5	1002	83°	15-E020	- DL - CL	ON-OFF	220-240V			
						14					
						60					
						34					
						Z5					
						J6					
						E3					
4000	80	9.5	1002	83°	15-E020	- DL - CM	ON-OFF	220-240V			
						14					
						60					
						34					

## Cosmos Ceiling 168mm

IP	IK	BREEAM	LED	DRIVER
66	08			

Z5 14\* 60\* 34\* J6\* E3\* DL\*

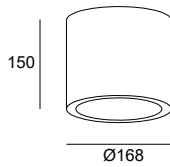

LED											
K	CRI	W Total	Real Lm	Optics	Code						
						Z5					
						J6					
						E3					
3000	80	25.8	2061	90°	15-9904	- DL - CL	ON-OFF	100-240V			
						14					
						60					
						34					
						Z5					
						J6					
						E3					
4000	80	25.8	2061	90°	15-9904	- DL - CM	ON-OFF	100-240V			
						14					
						60					
						34					

## Cosmos Ceiling 126mm

IP	IK	BREEAM	LED
66	08		

Z5 14\* 60\* 34\* J6\* E3\* DL\*

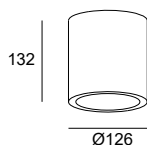

LED									
K	CRI	W	Total	Real	Lm	Optics	Code		
								Z5	
								J6	
								E3	
3000	80	17.6	1118	83°	15-9790	- DL - CL	ON-OFF	100-240V	
								14	
								60	
								34	
								Z5	
								J6	
								E3	
4000	80	17.6	1118	83°	15-9790	- DL - CM	ON-OFF	100-240V	
								14	
								60	
								34	

### Accesorios decorativos Acessórios decorativos



Set de 2 decoreflector (plata y dorado)  
 Set de 2 decorrefletor (prata e dourado)

Included

\* Consulte condiciones y plazos de entrega a nuestro equipo comercial.

\* Consultar a nossa equipa comercial para informações sobre as condições e os prazos de entrega.

# Modis

Designed by Luca Turrini



+ Modis

**COLLECTION:** Spotlights, Wall Fixtures, Bollards/Lampost

## Libertad total de movimiento Total liberdade de movimento

La iluminación focalizada y precisa de Modis plafón armoniza los ambientes en los que se encuentra, dotándolos, no sólo de estilo y clase, sino también de una luz de calidad, uniforme y confortable. La versatilidad de la colección y sus opciones de estructura y ópticas, la convierten en una elección idónea tanto en espacios reducidos como en aquellos que disponen de gran amplitud.

A iluminação focada e precisa de Modis plafon harmoniza os ambientes onde é colocado, dando-lhes não só estilo e classe, como também uma luz de qualidade, uniforme e confortável. A versatilidade da coleção e as suas opções de estrutura e óticas tornam-na uma escolha ideal tanto para espaços reduzidos como para os de grande amplitude.

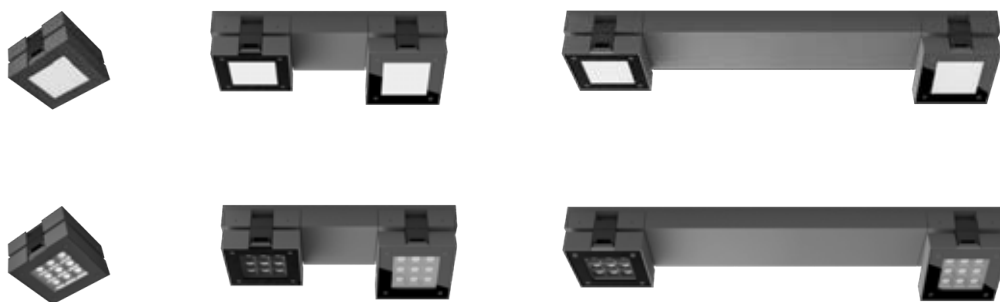

14

34

DL

E3

J6

Z5

60







# Modis Ceiling

BODY MAT	DIF MAT		50000h	3
AL	GLA		L80 B20	MacAdam

## Modis Opal Single

IP	IK	SWITCH CCT		SEA SIDE SUITABLE				
66	10	SW 2700-3200-4000						

Z5 14\* 60\* 34\* J6\* E3\* DL\*

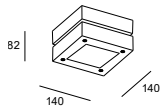
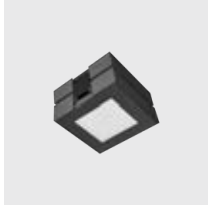

LED									
K	CRI	W Total	Real Lm	Optics Code					
					Z5				
					J6				
					E3	OU	ON-OFF	100-277V	
SW 2700-3200-4000	80	13.2	744	107°	05-E062	- DL - DU	DALI-2	100-277V	
					14	XB	CASAMBI	220-240V	
					60				
					34				

## Modis Opal Double 430mm

IP	IK	BREEAM	SWITCH CCT		SEA SIDE SUITABLE				
66	10		SW 2700-3200-4000						

Z5 14\* 60\* 34\* J6\* E3\* DL\*

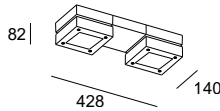

LED									
K	CRI	W Total	Real Lm	Optics Code					
					Z5				
					J6				
					E3	OU	ON-OFF	100-277V	
SW 2700-3200-4000	80	2 × 13.2	1488	107°	05-E063	- DL - DU	DALI-2	100-277V	
					14	XB	CASAMBI	220-240V	
					60				
					34				

## Modis Opal Double 800mm

IP	IK	BREEAM	SWITCH CCT		SEA SIDE SUITABLE				
66	10		SW 2700-3200-4000						

Z5 14\* 60\* 34\* J6\* E3\* DL\*

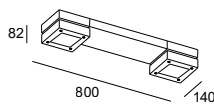

LED									
K	CRI	W Total	Real Lm	Optics Code					
					Z5				
					J6				
					E3	OU	ON-OFF	100-277V	
SW 2700-3200-4000	80	2 × 13.2	1488	107°	05-E064	- DL - DU	DALI-2	100-277V	
					14	XB	CASAMBI	220-240V	
					60				
					34				

\* Consulte condiciones y plazos de entrega a nuestro equipo comercial.  
 \* Consultar a nossa equipa comercial para informações sobre as condições e os prazos de entrega.



## Modis Optics Simple



Ejemplo de código / Exemplo de código: **AS11-18V9S3OUZ5**

Model	W	K / CRI/ Real lm	Optics	Source	Finishes
<b>AS11 -</b> 	<b>18</b> 20W	<b>V9</b> 2700K / CRI90 / 1680 lm	<b>S3</b> 16°	<b>OU</b> ON-OFF 100-277V	<b>Z5*</b> <b>14*</b> <b>60*</b> <b>34*</b> <b>J6*</b> <b>E3*</b> <b>DL*</b>
		<b>W9</b> 3000K / CRI90 / 1914 lm	<b>M3</b> 38°	<b>DS</b> DALI-2/PUSH 220-240V	
		<b>X9</b> 4000K / CRI90 / 1966 lm	<b>F1</b> 48°	<b>XB</b> CASAMBI 220-240V	

## Modis Optics Double 430mm



Ejemplo de código / Exemplo de código: **AS12-37V9S3OUZ5**

Model	W	K / CRI/ Real lm	Optics	Source	Finishes
<b>AS12 -</b> 	<b>37</b> 2 x 20W	<b>V9</b> 2700K / CRI90 / 3360 lm	<b>S3</b> 16°	<b>OU</b> ON-OFF 100-277V	<b>Z5</b> <b>14*</b> <b>60*</b> <b>34*</b> <b>J6*</b> <b>E3*</b> <b>DL*</b>
		<b>W9</b> 3000K / CRI90 / 3828 lm	<b>M3</b> 38°	<b>DS</b> DALI-2/PUSH 220-240V	
		<b>X9</b> 4000K / CRI90 / 3932 lm	<b>F1</b> 48°	<b>XB</b> CASAMBI 220-240V	

## Modis Optics Double 800mm



Ejemplo de código / Exemplo de código: **AS13-37V9S3OUZ5**

Model	W	K / CRI/ Real lm	Optics	Source	Finishes
<b>AS13 -</b> 	<b>37</b> 2 x 20W	<b>V9</b> 2700K / CRI90 / 3360 lm	<b>S3</b> 16°	<b>OU</b> ON-OFF 100-277V	<b>Z5</b> <b>14*</b> <b>60*</b> <b>34*</b> <b>J6*</b> <b>E3*</b> <b>DL*</b>
		<b>W9</b> 3000K / CRI90 / 3828 lm	<b>M3</b> 38°	<b>DS</b> DALI-2/PUSH 220-240V	
		<b>X9</b> 4000K / CRI90 / 3932 lm	<b>F1</b> 48°	<b>XB</b> CASAMBI 220-240V	

\* Consulte condiciones y plazos de entrega a nuestro equipo comercial.  
 \* Consultar a nossa equipa comercial para informações sobre as condições e os prazos de entrega.

Modis Opal &  
Optics SingleModis Opal & Optics  
Double 430mmModis Opal & Optics  
Double 800mm**Accesorios ópticos**  
Acessórios óticosVisera  
Viseira

Z5 ●	71-E234-Z5-00	71-E234-Z5-00	71-E234-Z5-00
J6 ● *	71-E234-J6-00	71-E234-J6-00	71-E234-J6-00
E3 ● *	71-E234-E3-00	71-E234-E3-00	71-E234-E3-00
DL ● *	71-E234-DL-00	71-E234-DL-00	71-E234-DL-00
14 ○ *	71-E234-14-00	71-E234-14-00	71-E234-14-00
60 ● *	71-E234-60-00	71-E234-60-00	71-E234-60-00
34 ○ *	71-E234-34-00	71-E234-34-00	71-E234-34-00

**Accesorios de fijación**  
Acessórios de fixaçãoEstaca de 302mm  
Estaca de 302 mm

71-9998-05-05

-

-

Estaca de 235mm  
Estaca de 235 mm

71-9997-05-05

-

-

**Accesorios de unión**  
Acessórios de uniãoPlaca concatenadora  
Placa de união

Z5 ●	-	71-E235-Z5-00	71-E235-Z5-00
J6 ● *	-	71-E235-J6-00	71-E235-J6-00
E3 ● *	-	71-E235-E3-00	71-E235-E3-00
DL ● *	-	71-E235-DL-00	71-E235-DL-00
14 ○ *	-	71-E235-14-00	71-E235-14-00
60 ● *	-	71-E235-60-00	71-E235-60-00
34 ○ *	-	71-E235-34-00	71-E235-34-00

\* Consulte condiciones y plazos de entrega a nuestro equipo comercial.

\* Consultar a nossa equipa comercial para informações sobre as condições e os prazos de entrega.



# Bento IP66

Designed by LedsC4 Architectural



60 mm

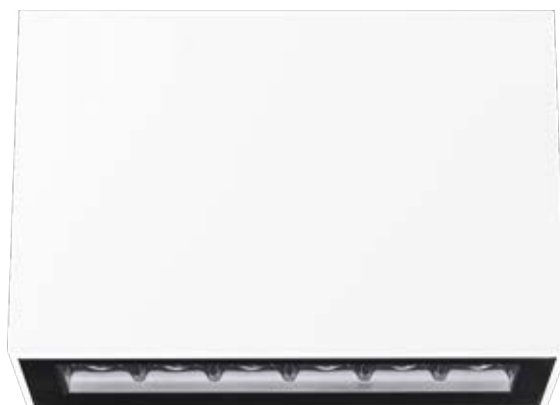

189 mm

## Full IP66

Protección full IP66 que permite instalar la luminaria en espacios donde haya humedad o exposición al polvo y al agua.

Proteção full IP66 que permite a instalação da luminária em espaços com humidade ou exposição ao pó e à água.



# Bento Surface

BODY MAT	50000h	3
AL	L80 B20	MacAdam

## Bento Surface 6 LEDS IP66

IP	NEW	IK	UGR	DIF MAT				
66		09	<13	GLA		DIM		

Z5	14	60	34	J6	E3 DL

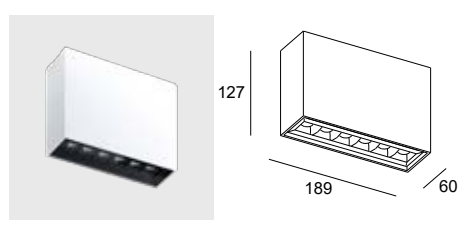

LED						
K	CRI	W Total	Real Lm	Optics	Code	
2700	90	14.7	1119	18°	<b>15-A116</b>	<b>Z5</b>
2700	90	14.7	1276	38°	<b>15-A117</b>	<b>J6</b>
2700	90	14.7	1205	47°	<b>15-A118</b>	<b>E3</b>
						<b>OU</b> ON-OFF 100-277V
						<b>DL</b> DALI-2 220-240V
						<b>14</b>
						<b>60</b>
						<b>34</b>
3000	90	14.7	1119	18°	<b>15-A119</b>	<b>Z5</b>
3000	90	14.7	1276	38°	<b>15-A120</b>	<b>J6</b>
3000	90	14.7	1205	47°	<b>15-A121</b>	<b>E3</b>
						<b>OU</b> ON-OFF 100-277V
						<b>DL</b> DALI-2 220-240V
						<b>14</b>
						<b>60</b>
						<b>34</b>
4000	90	14.7	1216	18°	<b>15-A122</b>	<b>Z5</b>
4000	90	14.7	1387	38°	<b>15-A123</b>	<b>J6</b>
4000	90	14.7	1310	47°	<b>15-A124</b>	<b>E3</b>
						<b>OU</b> ON-OFF 100-277V
						<b>DL</b> DALI-2 220-240V
						<b>14</b>
						<b>60</b>
						<b>34</b>

# Mega



+ Mega

## Gran tamaño para para grandes áreas Grandes dimensões para grandes áreas

El gran tamaño de Mega, con una base de hasta 1,2 metros de diámetro, resulta ideal para iluminar espacios muy amplios, tanto de interior como de exterior. Sus altas prestaciones y el diseño atemporal de la colección, la convierten en una opción ideal para proyectos tanto profesionales como domésticos, que requieren elegancia y calidad a partes iguales.

O tamanho grande de Mega, com uma base de até 1,2 metros de diâmetro, é ideal para iluminar espaços muito amplos, tanto de interior como de exterior. O seu elevado desempenho e o design intemporal da coleção fazem dela a escolha ideal tanto para projetos profissionais como domésticos que requerem elegância e qualidade em igual medida.



1200 mm



800 mm

## Instalación en techo o pared Instalação no teto ou parede





BODY MAT
AL

DIF MAT
PLABS



50000h
L80 B20

3
MacAdam

## Mega Ceiling 800mm

IP
65

IK
10

UGR
<16

LOW
FLICKER

BREEAM
--------

SWITCH CCT
SW 3000-4000



SEA SIDE
SUITABLE



M1

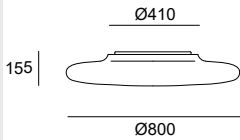

LED						
K	CRI	W Total	Real Lm	Code		
SW 3000-4000	80	81.4	8062	15-E110 - M1 - EH	DALI 100-277V	

## Mega Ceiling 1200mm

IP
65

IK
10

UGR
<13

LOW
FLICKER

BREEAM
--------

SWITCH CCT
SW 3000-4000



SEA SIDE
SUITABLE



M1

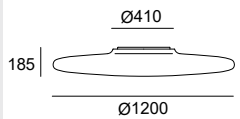

LED						
K	CRI	W Total	Real Lm	Code		
SW 3000-4000	80	81.4	8303	15-E111 - M1 - EH	DALI 100-277V	

## Controladores

P. 1166



CASAMBI\*  
IP67

BROADCAST

71-A237-00-00

\*DALI driver required.



# Afrodita



Wall Fixtures P.000

+ Afrodita

## Las ventajas del diseño con bombilla GU10 As vantagens do design com lâmpada GU10

Un plafón clásico, de forma cuadrada y diseño funcional; Afrodita es un esencial que se adapta con facilidad a toda necesidad, por su estilo neutro y las ventajas de su funcionamiento con bombilla GU10, lo que economiza el proyecto y evita averías.

Um plafon clássico, com uma forma quadrada e design funcional; Afrodita é um essencial que se adapta com facilidade a todas as necessidades, graças ao seu estilo neutro e às vantagens do seu funcionamento com a lâmpada GU10, o que economiza o projeto e evita avarias.



## Afrodita GU10 Ceiling

BODY MAT
AL

DIF MAT
GLA



IP
54

IK
05

SEA SIDE
SUITABLE

● ○ ●  
Z5 14 34

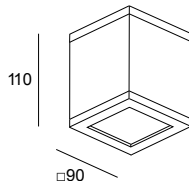
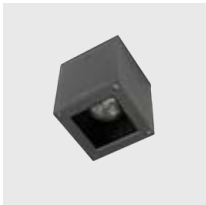

GU10	
<b>W</b>	<b>Code</b>
Max. 8	<b>Z5</b>
	<b>15-9480 - 14 - 37</b>
	<b>34</b>

**Resistente y atemporal**  
Resistente e intemporal

De diseño clásico y atemporal, esta colección de plafones proyecta una luz directa y se adapta con facilidad, gracias a su robusta forma cuadrada ligeramente redondeada en los cantos, a las condiciones de resistencia más extremas.  
De design clássico e intemporal, esta coleção de plafons projeta uma luz direta e adapta-se com facilidade às condições de resistência mais extremas, graças à sua forma quadrada robusta com arestas ligeiramente arredondadas.



## Kössel Ceiling

BODY MAT	DIF MAT	
PC+ABS	PC	

### Kössel Ceiling 300mm

IP	IK	SEA SIDE	LED	DRIVER
66	10	SUITABLE		

34

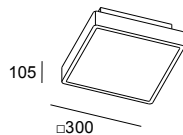

E27	<b>Code</b>
<b>W</b>	<b>15-9619 - 34 - M1</b>
2 × Max. 15	

### Kössel Ceiling 400mm

IP	IK	UGR	BREEAM	50000h	3	SEA SIDE	LED	DRIVER
66	10	<16		L80 B20	MacAdam	SUITABLE		

34

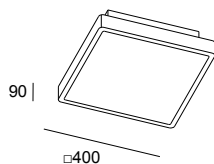

LED				
<b>K</b>	<b>CRI</b>	<b>W</b>	<b>Real Lm</b>	<b>Code</b>
3000	80	19	1172	<b>15-9806 - 34 - CL</b>

# Solid



Estanca profesional apta para uso intensivo  
 Estanque profissional adequada para uso intensivo

Con una gran protección frente a la entrada de agua, polvo y a posibles impactos vandálicos, Solid es una estanca profesional, con componentes electrónicos de calidad y un potente flujo luminoso, que se adapta con fiabilidad a un uso intensivo.

Com uma grande proteção contra a entrada de água, poeira e possíveis atos de vandalismo, Solid é um estanque profissional com componentes eletrônicos de qualidade e um poderoso fluxo luminoso, que se adapta com fiabilidade a um uso intensivo.



Conexión externa y cable pasante que facilitan la instalación.  
 Ligaçao externa e cabo de passagem para facilitar a instalação.

Disponibile con sensor de movimiento integrado.  
 Disponível com sensor de movimento integrado.

# Solid

BODY MAT PC	DIF MAT PC		50000h L80 B20	5 MacAdam
----------------	---------------	--	-------------------	--------------

## Solid 1320mm

IP 66	IK 10	UGR <19	BREEAM		SEA SIDE SUITABLE	LED	DRIVER
----------	----------	------------	--------	--	----------------------	-----	--------

34

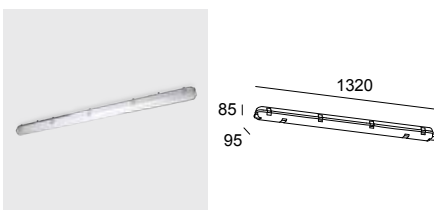

LED						
K	CRI	W Total	Real Lm	Code		
4000	80	30	2872	15-E000		ON-OFF 220-240V
				15-E002	- 34 - CM	ON-OFF / SENSOR
				15-E004		220-240V
						DALI 220-240V

Solid 1620mm

IP	IK	UGR	LOW	BREEAM		SEA SIDE SUITABLE		
66	10	<19	FLICKER					

34

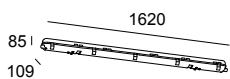

LED						
K	CRI	W Total	Real Lm	Code		
4000	80	65	6082	<b>15-E001</b>	ON-OFF 220-240V	
				<b>15-E003 - 34 - CM</b>	ON-OFF /	
				<b>15-E005</b>	SENSOR 220-240V 	
					DALI 220-240V	

# Chillout

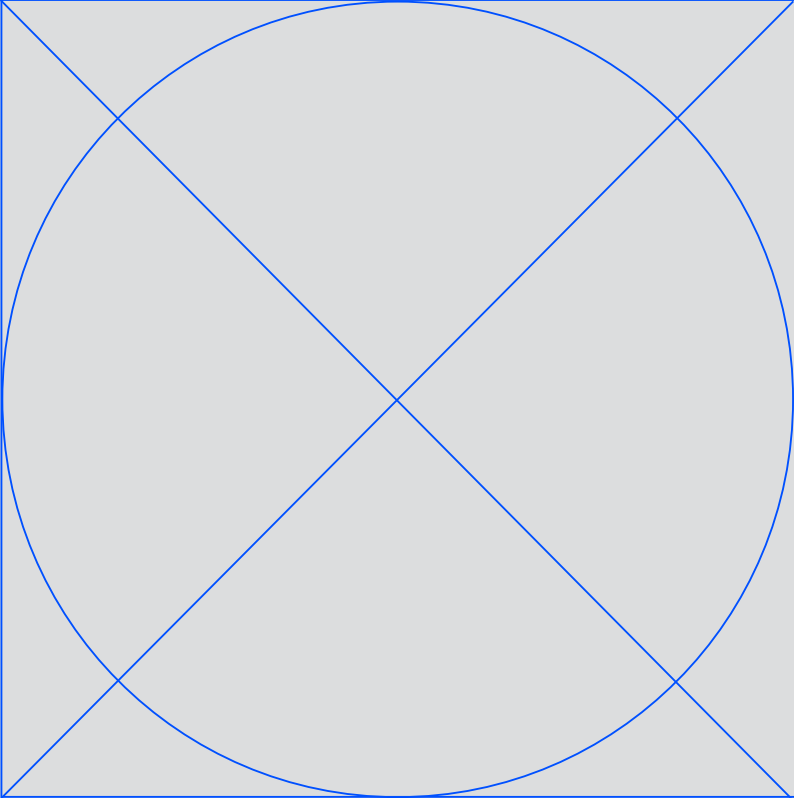

**Orbit**

**948**



**Rack**

**958**

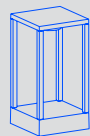

**Moal**

**970**

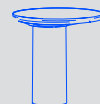

**Barcino**

**974**

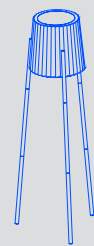

**Moonlight**

**976**



**Cisne**

**978**

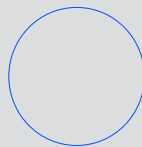

# Orbit

Designed by Luca Turrini



+ Orbit

FAMILIAS/FAMILIAS: Balizas y farolas/Balizas y farolas

## Iluminar acompañando Iluminar acompanhando

Orbit es la opción ideal para generar ambientes cálidos en zonas donde la iluminación es la clave del éxito para conectar con clientes y usuarios. De formas suaves y con diversas opciones de acabados y direcciones del haz de luz, la presencia de Orbit confiere un plus de calidad al espacio que habita.

Orbit é a opção ideal para criar ambientes cálidos em zonas onde a iluminação é a chave para o sucesso na ligação com clientes e utilizadores. De formas suaves e diversas opções de acabamentos e direções do feixe de luz, a presença de Orbit confere um plus de qualidade ao espaço onde se insere.



300 mm

1060 mm

1800 mm



14

34

DL

E3

J6

Z5

60











Opciones de luz en la parte superior del cabezal: punto de señalización, nula contaminación lumínica y suave luz hacia arriba.  
Opções de luz na parte superior da cabeça: ponto de sinalização, poluição lumínica nula e luz suave para cima.



Fijación para mesa de forma oculta.  
Fixação para mesa de forma oculta.

# Orbit Table Lamp

BODY MAT	DIF MAT	50000h	3
AL	PC	L80 B20	MacAdam

## Orbit Table Lamp Rechargeable Covered

NEW
IP 65
IK 10
BREEAM
SEA SIDE SUITABLE
LED
DRIVER

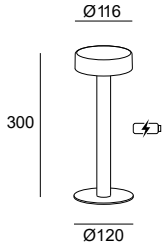

6H → 100% 6H 50% 12H 10% 60H Z5 14\* 60\* 34\* J6\* E3\* DL\*

LED						
K	CRI	W Total	Real Lm	Code		
2700	80	1.5	108	10-E019	Z5 J6 E3 - DL - CK 14 60 34	TOUCH DIMMING 5VDC 1000mA
3000	80	1.5	108	10-E019	Z5 J6 E3 - DL - CL 14 60 34	TOUCH DIMMING 5VDC 1000mA
4000	80	1.5	108	10-E019	Z5 J6 E3 - DL - CM 14 60 34	TOUCH DIMMING 5VDC 1000mA

## Orbit Table Lamp Rechargeable Small Hole Cover

NEW
IP 65
IK 10
BREEAM
SEA SIDE SUITABLE
LED
DRIVER

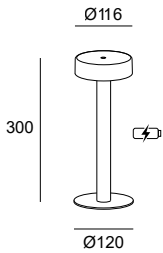

6H → 100% 6H 50% 12H 10% 60H Z5 14\* 60\* 34\* J6\* E3\* DL\*

LED						
K	CRI	W Total	Real Lm	Code		
2700	80	1.5	109	10-E020	Z5 J6 E3 - DL - CK 14 60 34	TOUCH DIMMING 5VDC 1000mA
3000	80	1.5	109	10-E020	Z5 J6 E3 - DL - CL 14 60 34	TOUCH DIMMING 5VDC 1000mA
4000	80	1.5	109	10-E020	Z5 J6 E3 - DL - CM 14 60 34	TOUCH DIMMING 5VDC 1000mA

**Orbit Table Lamp Rechargeable  
Big Hole Cover**

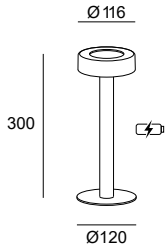

6H → 100% 6H 50% 12H 10% 60H Z5 14\* 60\* 34\* J6\* E3\* DL\*

LED						
K	CRI	W Total	Real Lm	Code		
2700	80	1.5	118	10-E021	Z5 J6 E3 DL - CK 14 60 34	TOUCH DIMMING 5VDC 1000mA
3000	80	1.5	118	10-E021	Z5 J6 E3 DL - CL 14 60 34	TOUCH DIMMING 5VDC 1000mA
4000	80	1.5	118	10-E021	Z5 J6 E3 DL - CM 14 60 34	TOUCH DIMMING 5VDC 1000mA

<b>Orbit Table Lamp Rechargeable Covered</b>	<b>Orbit Table Lamp Rechargeable Small Hole Cover</b>	<b>Orbit Table Lamp Rechargeable Big Hole Cover</b>

**Accesorios de fijación**  
Acessórios de fixação

	Estaca de 235mm Estaca de 235 mm	71-9997-05-05	71-9997-05-05	71-9997-05-05
	Kit antitirones Kit antipuxões	71-E293-00-00	71-E293-00-00	71-E293-00-00
	Fijación para mesa Fixação para mesa	71-E458-60-60	71-E458-60-60	71-E458-60-60

\* Consulte condiciones y plazos de entrega a nuestro equipo comercial.  
\* Consultar a nossa equipa comercial para informações sobre as condições e os prazos de entrega.



# Orbit Floor Lamp

BODY MAT	DIF MAT	50000h	3
AL	PC	L80 B20	MacAdam

## Orbit Floor Lamp Rechargeable Covered

NEW
IP 65
IK 10
BREEAM
SEA SIDE SUITABLE
LED DRIVER

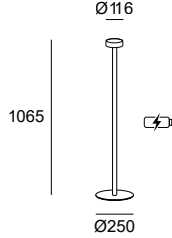

6H → 100% 6H 50% 12H 10% 60H

Z5 14\* 60\* 34\* J6\* E3\* DL\*

LED						
K	CRI	W Total	Real Lm	Code		
2700	80	1.5	108	25-E018	- DL - CK	TOUCH DIMMING 5VDC 1000mA
					Z5 J6 E3 14 60 34	
3000	80	1.5	108	25-E018	- DL - CL	TOUCH DIMMING 5VDC 1000mA
					Z5 J6 E3 14 60 34	
4000	80	1.5	108	25-E018	- DL - CM	TOUCH DIMMING 5VDC 1000mA
					Z5 J6 E3 14 60 34	

## Orbit Floor Lamp Rechargeable Small Hole Cover

NEW
IP 65
IK 10
BREEAM
SEA SIDE SUITABLE
LED DRIVER

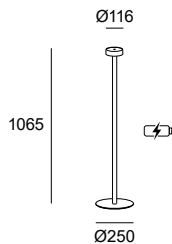

6H → 100% 6H 50% 12H 10% 60H

Z5 14\* 60\* 34\* J6\* E3\* DL\*

LED						
K	CRI	W Total	Real Lm	Code		
2700	80	1.5	109	25-E019	- DL - CK	TOUCH DIMMING 5VDC 1000mA
					Z5 J6 E3 14 60 34	
3000	80	1.5	109	25-E019	- DL - CL	TOUCH DIMMING 5VDC 1000mA
					Z5 J6 E3 14 60 34	
4000	80	1.5	109	25-E019	- DL - CM	TOUCH DIMMING 5VDC 1000mA
					Z5 J6 E3 14 60 34	

### Orbit Floor Lamp Rechargeable Big Hole Cover

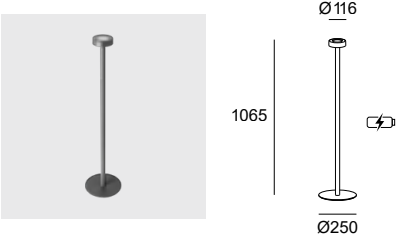

NEW
IP 65
IK 10
BREEAM
SEA SIDE SUITABLE
LED
DRIVER



6H → 100% 6H 50% 12H 10% 60H

Z5 14\* 60\* 34\* J6\* E3\* DL\*

LED						
K	CRI	W Total	Real Lm	Code		
2700	80	1.5	118	25-E020	Z5 J6 E3 DL - CK 14 60 34	TOUCH DIMMING 5VDC 1000mA
3000	80	1.5	118	25-E020	Z5 J6 E3 DL - CL 14 60 34	TOUCH DIMMING 5VDC 1000mA
4000	80	1.5	118	25-E020	Z5 J6 E3 DL - CM 14 60 34	TOUCH DIMMING 5VDC 1000mA

<b>Orbit Floor Lamp Rechargeable Covered</b> 	<b>Orbit Floor Lamp Rechargeable Small Hole Cover</b> 	<b>Orbit Floor Lamp Rechargeable Big Hole Cover</b> 
--------------------------------------------------------------------------------------------------------------------------------------	------------------------------------------------------------------------------------------------------------------------------------------------	----------------------------------------------------------------------------------------------------------------------------------------------

### Accesorios de fijación Acessórios de fixação

 Estaca de 235mm Estaca de 235 mm	71-9997-05-05	71-9997-05-05	71-9997-05-05
-------------------------------------------------------------------------------------------------------------------------	---------------	---------------	---------------

\* Consulte condiciones y plazos de entrega a nuestro equipo comercial.  
\* Consultar a nossa equipa comercial para informações sobre as condições e os prazos de entrega.



### Orbit Floor Lamp Plug&Play Covered

<b>NEW</b>	IP 66	IK 10		BREEAM	SWITCH CCT SW 2700-3200-4000	 3 m			
------------	----------	----------	--	--------	---------------------------------	---------	--	--	--

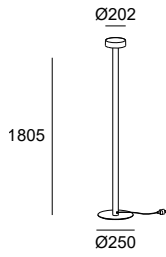

Z5 14\* 60\* 34\* J6\* E3\* DL\*

LED										
K	CRI	W	Total	Real Lm	Code					
						<b>Z5</b>				
						<b>J6</b>				
						<b>E3</b>				
SW 2700-3200-4000	80	11.5		761	<b>25-E021</b>	- DL - EH	ON-OFF	100-240V		
						<b>14</b>				
						<b>60</b>				
						<b>34</b>				

### Orbit Floor Lamp Plug&Play Small Hole Cover

<b>NEW</b>	IP 66	IK 10		BREEAM	SWITCH CCT SW 2700-3200-4000	 3 m			
------------	----------	----------	--	--------	---------------------------------	---------	--	--	--

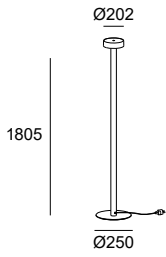

Z5 14\* 60\* 34\* J6\* E3\* DL\*

LED										
K	CRI	W	Total	Real Lm	Code					
						<b>Z5</b>				
						<b>J6</b>				
						<b>E3</b>				
SW 2700-3200-4000	80	11.5		764	<b>25-E022</b>	- DL - EH	ON-OFF	100-240V		
						<b>14</b>				
						<b>60</b>				
						<b>34</b>				

\* Consulte condiciones y plazos de entrega a nuestro equipo comercial.  
 \* Consultar a nossa equipa comercial para informações sobre as condições e os prazos de entrega.

# Orbit Floor Lamp Plug&Play Big Hole Cover

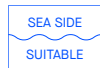
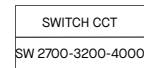

OUTDOOR

Z5 14\* 60\* 34\* J6\* E3\* DL\*

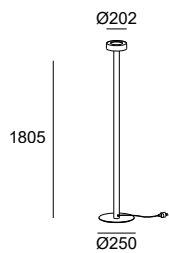

LED						
K	CRI	W Total	Real Lm	Code		
SW 2700-3200-4000	80	11.5	858	<b>25-E023</b>	- DL - EH	ON-OFF 100-240V
					Z5	
					J6	
					E3	
					14	
					60	
					34	

Orbit Floor Lamp Plug&Play Covered



Orbit Floor Lamp Plug&Play Small Hole Cover



Orbit Floor Lamp Plug&Play Big Hole Cover



## Accesorios de fijación Acessórios de fixação



Estaca de 235mm  
Estaca de 235 mm

-

-

-

CHILLOUT

\* Consulte condiciones y plazos de entrega a nuestro equipo comercial.  
\* Consultar a nossa equipa comercial para informações sobre as condições e os prazos de entrega.

# Rack

Designed by Luca Turrini



+ Rack

**FAMILIAS/FAMILIAS:** Apliques/Apliques. Balizas/Balizas.



Máxima flexibilidad para una mejor adaptación a los espacios  
Máxima flexibilidade para uma melhor adaptação aos espaços

Rack ha sido minuciosamente desarrollada para aquellos proyectos donde iluminar y decorar con personalidad no es suficiente, sino que la fiabilidad es un factor igual o incluso más importante. Esta colección dispone de altas prestaciones como IP66, regulación DALI, eficiencia BREEAM o tratamiento contra la atmósfera marina.

Rack foi cuidadosamente desenvolvida para aqueles projetos em que a iluminação e a decoração com personalidade não é suficiente, sendo a fiabilidade um fator igualmente ou ainda mais importante. Esta coleção possui características de alto desempenho como IP66, regulação DALI, eficiência BREEAM ou tratamento contra a atmosfera marinha.



14

34

DL

E3

J6

Z5

60





# Rack Rechargeable

BODY MAT	DIF MAT	50000h	3
AL.CON	GLA	L80 B20	MacAdam

## Rack Rechargeable 100×100×270mm

IP 65	IK 10		BREEAM			
----------	----------	--	--------	--	--	--

6H → 100% 6H 50% 12H 10% 60H Z5\* 14\* 60 34\* J6\* E3\* DL\*

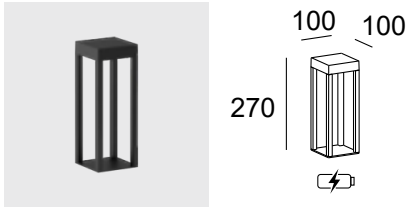

10-E001 10-E002 10-E003

LED	K	CRI	W Total	Real Lm	Code
					Z5 J6 10-E001 E3 10-E002 - DL - CK 10-E003 14 60 34
	2700	80	1.5	88	
					Z5 J6 10-E001 E3 10-E002 - DL - CL 10-E003 14 60 34
	3000	80	1.5	88	
					Z5 J6 10-E001 E3 10-E002 - DL - CM 10-E003 14 60 34
	4000	80	1.5	88	

## Rack Rechargeable 150×150×300mm

IP 66	IK 06		BREEAM	SWITCH CCT SW 2700-3200-4000			
----------	----------	--	--------	---------------------------------	--	--	--

13H → 100% 12H 50% 30H 10% 100H Z5\* 14\* 60 34\* J6\* E3\* DL\*

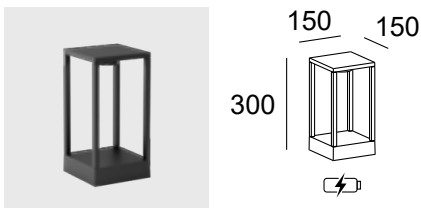

10-E010 10-E011 10-E012

LED	K	CRI	W Total	Real Lm	Code
					Z5 J6 10-E010 E3 10-E011 - DL - EH 10-E012 14 60 34
	SW 2700-3200-4000	80	3	174	

\* Consulte condiciones y plazos de entrega a nuestro equipo comercial.  
\* Consultar a nossa equipa comercial para informações sobre as condições e os prazos de entrega.

**Rack Rechargeable**  
260×260×300mm

IP 66	IK 06		BREEAM	SWITCH CCT SW 2700-3200-4000	SEA SIDE SUITABLE	LED	DRIVER
----------	----------	--	--------	---------------------------------	----------------------	-----	--------

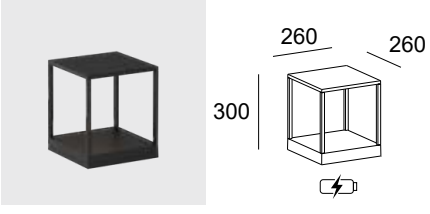

13H → 100% 12H 50% 30H 10% 100H Z5\* 14\* 60 34\* J6\* E3\* DL\*

LED					
K	CRI	W Total	Real Lm	Code	
				Z5	
				J6	
				10-E014	E3
SW 2700-3200-4000	80	3	174	10-E015	- DL - EH
				10-E017	14
					60
					34

**Rack Rechargeable**  
150×150×700mm

IP 66	IK 06		BREEAM	SWITCH CCT SW 2700-3200-4000	SEA SIDE SUITABLE	LED	DRIVER
----------	----------	--	--------	---------------------------------	----------------------	-----	--------

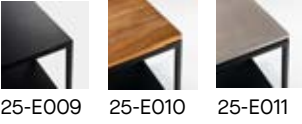
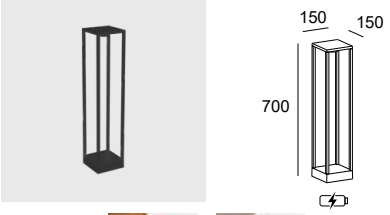

13H → 100% 12H 50% 30H 10% 100H Z5\* 14\* 60 34\* J6\* E3\* DL\*

LED					
K	CRI	W Total	Real Lm	Code	
				Z5	
				J6	
				25-E009	E3
SW 2700-3200-4000	80	3	174	25-E010	- DL - EH
				25-E011	14
					60
					34

**Rack Rechargeable**  
260×260×900mm

IP 66	IK 06		BREEAM	SWITCH CCT SW 2700-3200-4000	SEA SIDE SUITABLE	LED	DRIVER
----------	----------	--	--------	---------------------------------	----------------------	-----	--------

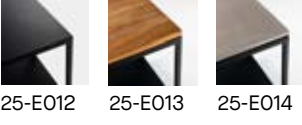

13H → 100% 12H 50% 30H 10% 100H Z5\* 14\* 60 34\* J6\* E3\* DL\*

LED					
K	CRI	W Total	Real Lm	Code	
				Z5	
				J6	
				25-E012	E3
SW 2700-3200-4000	80	3	174	25-E013	- DL - EH
				25-E014	14
					60
					34

\* Consulte condiciones y plazos de entrega a nuestro equipo comercial.  
\* Consultar a nossa equipa comercial para informações sobre as condições e os prazos de entrega.

Rack  
Rechargeable  
100×100×270mm



Rack  
Rechargeable  
150×150×300mm



Rack  
Rechargeable  
260×260×300mm



### Accesorios ópticos Acessórios óticos



Difusor esférico de cristal opal  
Difusor esférico de vidro opalino

-

71-E284-60-F9

71-E284-60-F9

### Accesorios de fijación Acessórios de fixação



Estaca  
Estaca

-

71-E357-60-00

71-E358-60-00



Kit 4 ruedas  
Kit 4 rodas

-

-

71-E292-60-00



Kit antitirones  
Kit antipuxões

71-E293-00-00

71-E293-00-00

71-E293-00-00

### Accesorios de conexión Acessórios de conexão



Cargador individual  
Carregador individual

71-E367-60-00

71-E367-60-00

71-E367-60-00



Cargador múltiple  
Carregador múltiplo

71-8332-05-00

71-8332-05-00

71-8332-05-00

### Accesorios decorativos Acessórios decorativos



Set rejillas decorativas (4u.)  
Set grelhas decorativas (4u.)

60 ●

71-E294-60-00

71-E279-60-00

71-E281-60-00

Z5 ● \*

71-E294-Z5-00

71-E279-Z5-00

71-E281-Z5-00

J6 ● \*

71-E294-J6-00

71-E279-J6-00

71-E281-J6-00

E3 ● \*

71-E294-E3-00

71-E279-E3-00

71-E281-E3-00

DL ● \*

71-E294-DL-00

71-E279-DL-00

71-E281-DL-00

14 ○ \*

71-E294-14-00

71-E279-14-00

71-E281-14-00

34 ○ \*

71-E294-34-00

71-E279-34-00

71-E281-34-00





Rack  
Rechargeable  
150×150×700mm



Rack  
Rechargeable  
260×260×900mm



### Accesorios ópticos Acessórios óticos



Difusor esférico de cristal opal  
Difusor esférico de vidro opalino

71-E284-60-F9

71-E284-60-F9

### Accesorios de fijación Acessórios de fixação



Estaca  
Estaca

71-E357-60-00

71-E358-60-00



Kit 4 ruedas  
Kit 4 rodas

-

71-E292-60-00



Kit antitirones  
Kit antipuxões

71-E293-00-00

71-E293-00-00

### Accesorios de conexión Acessórios de conexão



Cargador individual  
Carregador individual

71-E367-60-00

71-E367-60-00



Cargador múltiple  
Carregador múltiplo

71-8332-05-00

71-8332-05-00

### Accesorios decorativos Acessórios decorativos



Set rejillas decorativas (4u.)  
Set grelhas decorativas (4u.)

60 ● 71-E280-60-00

71-E282-60-00

Z5 ● \* 71-E280-Z5-00

71-E282-Z5-00

J6 ● \* 71-E280-J6-00

71-E282-J6-00

E3 ● \* 71-E280-E3-00

71-E282-E3-00

DL ● \* 71-E280-DL-00

71-E282-DL-00

14 ○ \* 71-E280-14-00

71-E282-14-00

34 ○ \* 71-E280-34-00

71-E282-34-00

# Rack Plug&Play

BODY MAT	DIF MAT	50000h	3
AL.CON	GLA	L80 B20	MacAdam

## Rack Plug&Play 150x150x160mm

IP 66	IK 06		BREEAM	SWITCH CCT SW 2700-3200-4000		SEA SIDE SUITABLE		
----------	----------	--	--------	---------------------------------	--	----------------------	--	--

● ● ● ● ● ● ● ●  
Z5\* 14\* 60 34\* J6\* E3\* DL\*

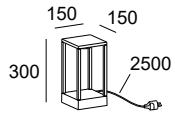

10-E004 10-E005 10-E006

LED							
K	CRI	W Total	Real Lm	Code			
SW 2700-3200-4000	80	14.9	760	10-E004	Z5		
				10-E005	J6		
				10-E006	E3	OU	ON-OFF 100-277V
					DL	XB	CASAMBI 220-240V
					14		
					60		
					34		

## Rack Plug&Play 260x260x300mm

IP 66	IK 06		BREEAM	SWITCH CCT SW 2700-3200-4000		SEA SIDE SUITABLE		
----------	----------	--	--------	---------------------------------	--	----------------------	--	--

● ● ● ● ● ● ● ●  
Z5\* 14\* 60 34\* J6\* E3\* DL\*

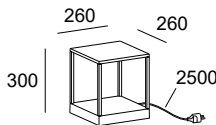

10-E007 10-E008 10-E009

LED							
K	CRI	W Total	Real Lm	Code			
SW 2700-3200-4000	80	14.9	760	10-E007	Z5		
				10-E008	J6		
				10-E009	E3	OU	ON-OFF 100-277V
					DL	XB	CASAMBI 220-240V
					14		
					60		
					34		

## Rack Plug&Play 150x150x700mm

IP 66	IK 06		BREEAM	SWITCH CCT SW 2700-3200-4000		SEA SIDE SUITABLE		
----------	----------	--	--------	---------------------------------	--	----------------------	--	--

● ● ● ● ● ● ● ●  
Z5\* 14\* 60 34\* J6\* E3\* DL\*

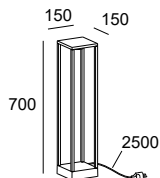

25-E006 25-E007 25-E008

LED							
K	CRI	W Total	Real Lm	Code			
SW 2700-3200-4000	80	14.9	760	25-E006	Z5		
				25-E007	J6		
				25-E008	E3	OU	ON-OFF 100-277V
					DL	XB	CASAMBI 220-240V
					14		
					60		
					34		

**Rack Plug&Play**  
260×260×900mm

IP 66	IK 06		BREEAM	SWITCH CCT SW 2700-3200-4000	 2.5 m	SEA SIDE SUITABLE		
----------	----------	--	--------	---------------------------------	-----------	----------------------	--	--

Z5\* 14\* 60 34\* J6\* E3\* DL\*

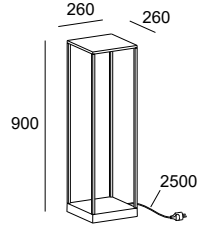

25-E000 25-E001 25-E002

LED		K		CRI	W	Total	Real Lm	Code		
SW 2700-	3200-	4000	80	14.9	760			25-E000	Z5	
								25-E001	J6	
								25-E002	E3	
									DL	OU ON-OFF 100-277V
									14	XB CASAMBI 220-240V
									60	
									34	

Rack Plug&Play 150×150×160mm	Rack Plug&Play 260×260×300mm	Rack Plug&Play 150×150×700mm	Rack Plug&Play 260×260×900mm

**Accesorios ópticos**  
Acessórios óticos



Difusor esférico de cristal opal  
Difusor esférico de vidro opalino

71-E284-60-F9	71-E284-60-F9	71-E284-60-F9	71-E284-60-F9
---------------	---------------	---------------	---------------

**Accesorios de fijación**  
Acessórios de fixação



Estaca  
Estaca

71-E357-60-00	71-E358-60-00	71-E357-60-00	71-E358-60-00
---------------	---------------	---------------	---------------



Kit 4 ruedas  
Kit 4 rodas

-	71-E292-60-00	-	71-E292-60-00
---	---------------	---	---------------

**Accesorios decorativos**  
Acessórios decorativos



Set rejillas decorativas (4u.)  
Set grelhas decorativas (4u.)

Z5		71-E279-Z5-00	71-E281-Z5-00	71-E280-Z5-00	71-E282-Z5-00
J6		71-E279-J6-00	71-E281-J6-00	71-E280-J6-00	71-E282-J6-00
E3		71-E279-E3-00	71-E281-E3-00	71-E280-E3-00	71-E282-E3-00
DL		71-E279-DL-00	71-E281-DL-00	71-E280-DL-00	71-E282-DL-00
14		71-E279-14-00	71-E281-14-00	71-E280-14-00	71-E282-14-00
60		71-E279-60-00	71-E281-60-00	71-E280-60-00	71-E282-60-00
34		71-E279-34-00	71-E281-34-00	71-E280-34-00	71-E282-34-00

# Rack Bollard

BODY MAT	DIF MAT	50000h	3
AL.CON	GLA	L80 B20	MacAdam

## Rack Bollard Fixed 150×150×300mm

IP 66	IK 06		BREEAM	SWITCH CCT SW 2700-3200-4000				
----------	----------	--	--------	---------------------------------	--	--	--	--

● ● ● ● ● ● ● ●  
Z5\* 14\* 60 34\* J6\* E3\* DL\*

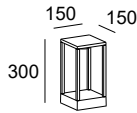

55-E057 55-E058 55-E059

LED		K		CRI	W	Total	Real Lm	Code				
									Z5			
									J6			
SW 2700-3200-4000	80	14.9	760	55-E057	E3	OU	ON-OFF	100-277V				
				55-E058	- DL	- DU	DALI-2	100-277V				
				55-E059	14	XB	CASAMBI	220-240V				
								60				
								34				

## Rack Bollard Fixed 260×260×300mm

IP 66	IK 06		BREEAM	SWITCH CCT SW 2700-3200-4000				
----------	----------	--	--------	---------------------------------	--	--	--	--

● ● ● ● ● ● ● ●  
Z5\* 14\* 60 34\* J6\* E3\* DL\*

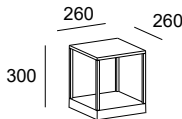

55-E063 55-E064 55-E065

LED		K		CRI	W	Total	Real Lm	Code				
									Z5			
									J6			
SW 2700-3200-4000	80	14.9	760	55-E063	E3	OU	ON-OFF	100-277V				
				55-E064	- DL	- DU	DALI-2	100-277V				
				55-E065	14	XB	CASAMBI	220-240V				
								60				
								34				

## Rack Bollard Fixed 150×150×700mm

IP 66	IK 06		BREEAM	SWITCH CCT SW 2700-3200-4000				
----------	----------	--	--------	---------------------------------	--	--	--	--

● ● ● ● ● ● ● ●  
Z5\* 14\* 60 34\* J6\* E3\* DL\*

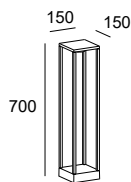

55-E060 55-E061 55-E062

LED		K		CRI	W	Total	Real Lm	Code				
									Z5			
									J6			
SW 2700-3200-4000	80	14.9	760	55-E060	E3	OU	ON-OFF	100-277V				
				55-E061	- DL	- DU	DALI-2	100-277V				
				55-E062	14	XB	CASAMBI	220-240V				
								60				
								34				

# Rack Bollard Fixed 260×260×900mm

IP
66

IK
06



BREEAM
--------

SWITCH CCT
SW 2700-3200-4000

2 m
-----

SEA SIDE
SUITABLE



OUTDOOR

Z5\* 14\* 60 34\* J6\* E3\* DL\*

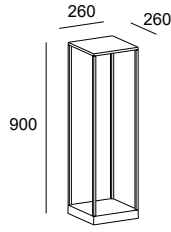

55-E066 55-E067 55-E068

LED		K		CRI W Total		Real Lm Code	
SW 2700-3200-4000	80	14.9	760	55-E066	55-E067	55-E068	
				Z5	J6	E3	OU ON-OFF 100-277V
				DL	DU	DL	DU DALI-2 100-277V
				14	XB	14	XB CASAMBI 220-240V
				60		60	
				34		34	

Rack Plug&Play  
150×150×160mm



Rack Plug&Play  
260×260×300mm



Rack Plug&Play  
150×150×700mm



Rack Plug&Play  
260×260×900mm



## Accesorios ópticos Acessórios óticos



Difusor esférico de cristal opal  
Difusor esférico de vidro opalino

71-E284-60-F9

71-E284-60-F9

71-E284-60-F9

71-E284-60-F9

## Accesorios de fijación Acessórios de fixação



Estaca  
Estaca

71-E357-60-00

71-E358-60-00

71-E357-60-00

71-E358-60-00



Kit 4 ruedas  
Kit 4 rodas

-

71-E292-60-00

-

71-E292-60-00

## Accesorios decorativos Acessórios decorativos



Set rejillas decorativas (4u.)  
Set grelhas decorativas (4u.)

Z5 ●

71-E279-Z5-00

71-E281-Z5-00

71-E280-Z5-00

71-E282-Z5-00

J6 ●

71-E279-J6-00

71-E281-J6-00

71-E280-J6-00

71-E282-J6-00

E3 ●

71-E279-E3-00

71-E281-E3-00

71-E280-E3-00

71-E282-E3-00

DL ●

71-E279-DL-00

71-E281-DL-00

71-E280-DL-00

71-E282-DL-00

14 ○

71-E279-14-00

71-E281-14-00

71-E280-14-00

71-E282-14-00

60 ●

71-E279-60-00

71-E281-60-00

71-E280-60-00

71-E282-60-00

34 ●

71-E279-34-00

71-E281-34-00

71-E280-34-00

71-E282-34-00

\* Consulte condiciones y plazos de entrega a nuestro equipo comercial.  
\* Consultar a nossa equipa comercial para informações sobre as condições e os prazos de entrega.

CHILLOUT

# Rack Wall Fixture

BODY MAT	DIF MAT	50000h	3
AL.CON	GLA	L80 B20	MacAdam

## Rack Wall Fixture 150×150×160mm

IP 66	IK 06		BREEAM	SWITCH CCT SW 2700-3200-4000		SEA SIDE SUITABLE	LED	DRIVER
----------	----------	--	--------	---------------------------------	--	----------------------	-----	--------

Z5\* 14\* 60 34\* J6\* E3\* DL\*

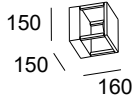

05-E071 05-E076 05-E077

LED									
K	CRI	W Total	Real Lm	Code					
					Z5				
					J6				
SW 2700-3200-4000	80	14.9	760	05-E071	E3	OU	ON-OFF	100-277V	
				05-E076	- DL -	DU	DALI-2	100-277V	
				05-E077	14	XB	CASAMBI	220-240V	
					60				
					34				

## Rack Wall Fixture 150×150×300mm



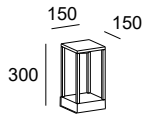

IP 66	IK 06		BREEAM	SWITCH CCT SW 2700-3200-4000		SEA SIDE SUITABLE	LED	DRIVER
----------	----------	--	--------	---------------------------------	--	----------------------	-----	--------

Z5\* 14\* 60 34\* J6\* E3\* DL\*



05-E082 05-E088 05-E089



LED									
K	CRI	W Total	Real Lm	Code					
					Z5				
					J6				
SW 2700-3200-4000	80	14.9	760	05-E082	E3	OU	ON-OFF	100-277V	
				05-E088	- DL -	DU	DALI-2	100-277V	
				05-E089	14	XB	CASAMBI	220-240V	
					60				
					34				

Rack Bollard Fixed 150×150×300mm	Rack Bollard Fixed 260×260×300mm	Rack Bollard Fixed 150×150×700mm	Rack Bollard Fixed 260×260×900mm
			

**Accesorios ópticos**  
**Accesórios óticos**

	Difusor esférico de cristal opal Difusor esférico de vidro opalino	71-E284-60-F9	71-E284-60-F9	71-E284-60-F9	71-E284-60-F9
-----------------------------------------------------------------------------------	-----------------------------------------------------------------------	---------------	---------------	---------------	---------------

**Accesorios de fijación**  
**Accesórios de fixação**

	Estaca de 302mm Estaca de 302 mm	71-9998-05-05	71-9998-05-05	71-9998-05-05	71-9998-05-05
	Estaca de 235mm Estaca de 235 mm	71-9997-05-05	71-9997-05-05	71-9997-05-05	71-9997-05-05

**Accesorios de conexión**  
**Accesórios de conexão**

	Conector IP68 (1 entrada + 1 salida) Ø 6 - 17mm, 5 polos Conetor IP68 (1 entrada + 1 saída) Ø 6 - 17 mm, 5 polos	71-E361-00-00	71-E361-00-00	71-E361-00-00	71-E361-00-00
	Conector anticondensación IP68 (1 entrada + 1 salida) Ø 5,5 - 12mm, 4 polos Conetor anticondensação IP68 (1 entrada + 1 saída) Ø 5,5 - 12 mm, 4 polos	71-E112-00-00	71-E112-00-00	71-E112-00-00	71-E112-00-00
	Conector anticondensación IP68 (1 entrada + 3 salidas) Ø 5,5 - 12mm, 4 polos Conetor anticondensação IP68 (1 entrada + 3 saídas) Ø 5,5 - 12 mm, 4 polos	71-E122-00-00	71-E122-00-00	71-E122-00-00	71-E122-00-00
	Caja de conexión IP68 (1 entrada + 5 salidas) Ø 6,5 - 11mm, 6 polos Caixa de ligação IP68 (1 entrada + 5 saídas) Ø 6,5 - 11 mm, 6 polos	71-9199-05-05	71-9199-05-05	71-9199-05-05	71-9199-05-05

**Accesorios decorativos**  
**Accesórios decorativos**

	Set rejillas decorativas (4u.) Set grelhas decorativas (4u.)	60 ●	71-E279-60-00	71-E281-60-00	71-E280-60-00	71-E282-60-00
		Z5 ● *	71-E279-Z5-00	71-E281-Z5-00	71-E280-Z5-00	71-E282-Z5-00
		J6 ● *	71-E279-J6-00	71-E281-J6-00	71-E280-J6-00	71-E282-J6-00
		E3 ● *	71-E279-E3-00	71-E281-E3-00	71-E280-E3-00	71-E282-E3-00
		DL ● *	71-E279-DL-00	71-E281-DL-00	71-E280-DL-00	71-E282-DL-00
		14 ○ *	71-E279-14-00	71-E281-14-00	71-E280-14-00	71-E282-14-00
		34 ○ *	71-E279-34-00	71-E281-34-00	71-E280-34-00	71-E282-34-00



# Moal

Designed by Francesc Vilaró



+ Moal



## Iluminación decorativa que funciona como mobiliario Iluminação decorativa que funciona como mobiliário

La colección Moal no es sólo una iluminación de baliza, sino que también puede utilizarse como mobiliario para exteriores de todo tipo, tanto en los que abunda la vegetación, como en otros más arquitectónicos donde su acabado en cemento permite una integración total en el ambiente.

A coleção Moal não é apenas uma iluminação de baliza, mas também pode ser utilizada como mobiliário para exteriores de todo o tipo, tanto onde a vegetação abunda como noutros mais arquitetónicos onde o seu acabamento em cimento permite a integração total no ambiente.



Los acabados de Moal son únicos gracias al cemento, un material noble y artesano cuya superficie irregular puede variar de una pieza a otra, convirtiéndolas en únicas.

Os acabamentos de Moal são únicos graças ao cimento, um material nobre e artesanal cuja superfície irregular pode variar de uma peça para outra, tornando-as únicas.







Además de ser una luminaria decorativa de exterior, Moal puede utilizarse como una pieza de mobiliario.  
Além de ser uma luminária decorativa de exterior, Moal também pode ser utilizada como uma peça de mobiliário.



Fabricada 100% con cemento.  
Cuenta con un refuerzo metálico en el interior para garantizar robustez y durabilidad.  
Fabricada 100% com cimento.  
Possui um reforço metálico no interior para garantir robustez e durabilidade.

# Moal Wall Fixture

BODY MAT	DIF MAT		50000h	3
AL.CON	PC		L80 B20	MacAdam

OUTDOOR

IP	IK	LOW		SEA SIDE SUITABLE		
66	10	FLICKER				

DC

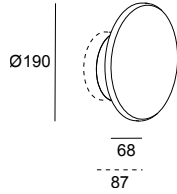

LED						
K	CRI	W Total	Real Lm	Code		
3000	90	11.1	312	05-E087 - DC - CL		ON-OFF 100-240V

## Accesorios de fijación Acessórios de fixação



Elevador  
Elevador

Included

# Moal Bollard

BODY MAT	DIF MAT		50000h	3
AL.CON	PC		L80 B20	MacAdam

## Moal 455mm

IP	IK		SEA SIDE SUITABLE			
66	10					

DC

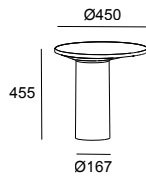

LED						
K	CRI	W Total	Real Lm	Code		
3000	90	16.3	729	55-E087 - DC - CL		ON-OFF 100-240V

## Moal 705mm

IP	IK		SEA SIDE SUITABLE			
66	10					

DC

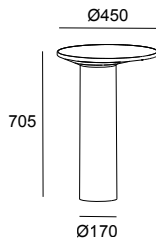

LED						
K	CRI	W Total	Real Lm	Code		
3000	90	16.3	729	55-E088 - DC - CL		ON-OFF 100-240V

## Accesorios de fijación Acessórios de fixação



Pernos de fijación  
Pernos de fixação

71-E157-00-00

CHILLOUT

# Barcino

Designed by Manel Llusçà

BODY MAT
AL

DIF MAT
PLABS



## Luz suave para grandes espacios Luz suave para grandes espaços

El difusor de rotomoldeo de Barcino permite iluminar con luz suave grandes espacios. Los diferentes acabados de la colección y sus tres alturas distintas, permite realizar composiciones únicas y con gran personalidad.

O difusor de rotomoldagem de Barcino permite iluminar grandes espaços com luz suave. Os diferentes acabamentos da coleção e as suas três alturas diferentes tornam possível a criação de composições únicas com grande personalidade.



14



34



DL



E3



J6



Z5



60



# Barcino

BODY MAT	DIF MAT	
AL	PLABS	

OUTDOOR

## Barcino

IP	IK		SEA SIDE	
65	10	5 m	SUITABLE	

Z5 14\* 60\* 34\* J6\* E3\* DL\*

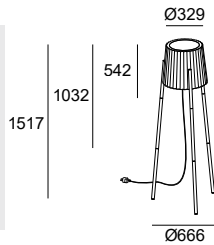

E27

**W**

Max. 15

**Code**

**Z5**

**J6**

**E3**

**55-9880 - DL - M1**

**14**

**60**

**34**

## Accesorios Smart Acessórios Smart



Bombilla E27 RGBW Wifi Light For Life  
Lâmpada E27 RGBW wi-fi Light For Life

**71-8219-00-00**

CHILLOUT

# Moonlight

## Funcional y acogedora Funcional e acolhedora

Como un elemento vivo, que comparte las necesidades del ambiente buscado, Moonlight pasa, con un solo gesto, de ofrecer una iluminación general, a armonizar el espacio con una iluminación más suave; para esos momentos confidentes de mayor intimidad.

Como elemento vivo que partilha as necessidades do ambiente desejado, Moonlight passa, com um único gesto, desde oferecer uma iluminação geral a harmonizar o espaço com uma iluminação mais suave; para aqueles momentos confidentes de maior intimidade.

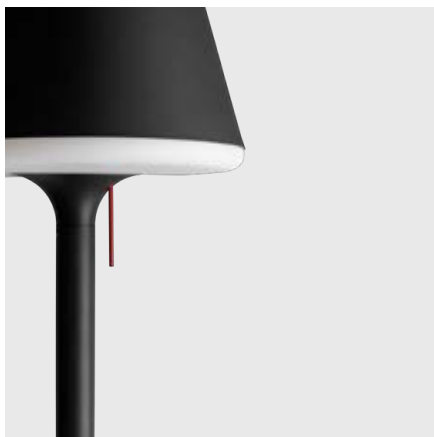



# Moonlight

BODY MAT  
AL



OUTDOOR

IP	IK	BREEAM	⊙	SEA SIDE
44	08		5 m	SUITABLE

●  
Z5

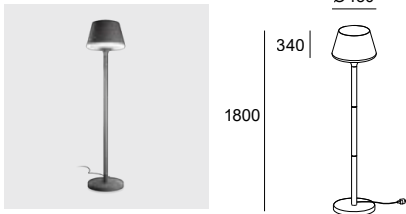

E27

**W**

Max. 15

**Code**

**25-9503 - Z5 - M1**

## Accesorios ópticos Acessórios óticos



Pantalla opaca  
Quebra-luz opaco

Included

## Accesorios de fijación Acessórios de fixação



Base para fijar al suelo  
Base para fixação no solo

Included

CHILLOUT

BODY MAT
AL



IP
44

IK
08

⊙
5 m

⏏
DIM



## Clásica, elegante y decorativa

## Clássica, elegante e decorativa

Cisne es una clásica esfera decorativa que aporta confort, calidez y elegancia a jardines y terrazas cuidados al detalle.

Cisne é uma esfera decorativa clássica que traz conforto, calidez e elegância aos jardins e terraços cuidados em detalhe.

### Cisne Pendant

Ø300 mm



Ø400 mm



### Cisne Surface

Ø300 mm



Ø400 mm



Ø500 mm





# Cisne Pendant

BODY MAT	DIF MAT	
PC	PMMA	

## Cisne Pendant ø300mm

IP	IK	BREEAM	(SC)
44	06		

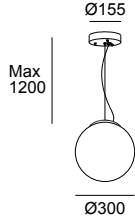

E27

**W**

Max. 15

**Code**

**00-9155 - 14 - M1**

○  
14

## Cisne Pendant ø400mm

IP	IK	BREEAM	(SC)
44	06		

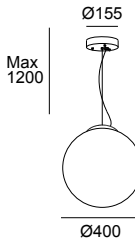

E27

**W**

Max. 15

**Code**

**00-9156 - 14 - M1**

○  
14

### Accesorios Smart Acessórios Smart



Bombilla E27 RGBW Wifi Light For Life  
Lâmpada E27 RGBW wi-fi Light For Life

**71-8219-00-00**

### Accesorios de fijación Acessórios de fixação



Estaca  
Estaca

Included

## Cisne Surface ø300mm

IP	IK	BREEAM	
44	06		

○  
M1

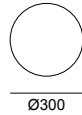

E27

**W**

Max. 15

**Code**

**55-9155 - M1 - M1**

## Cisne Surface ø400mm

IP	IK	BREEAM	
44	06		

○  
M1

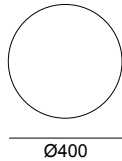

E27

**W**

Max. 15

**Code**

**55-9156 - M1 - M1**

## Cisne Surface ø500mm

IP	IK	BREEAM	
44	06		

○  
M1

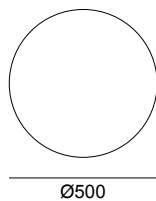

E27

**W**

Max. 15

**Code**

**55-9481 - M1 - M1**

### Accesorios Smart Acessórios Smart



Bombilla E27 RGBW Wifi Light For Life  
Lâmpada E27 RGBW wi-fi Light For Life

**71-8219-00-00**

### Accesorios de fijación Acessórios de fixação



Estaca  
Estaca

Included

# Emergency Lighting

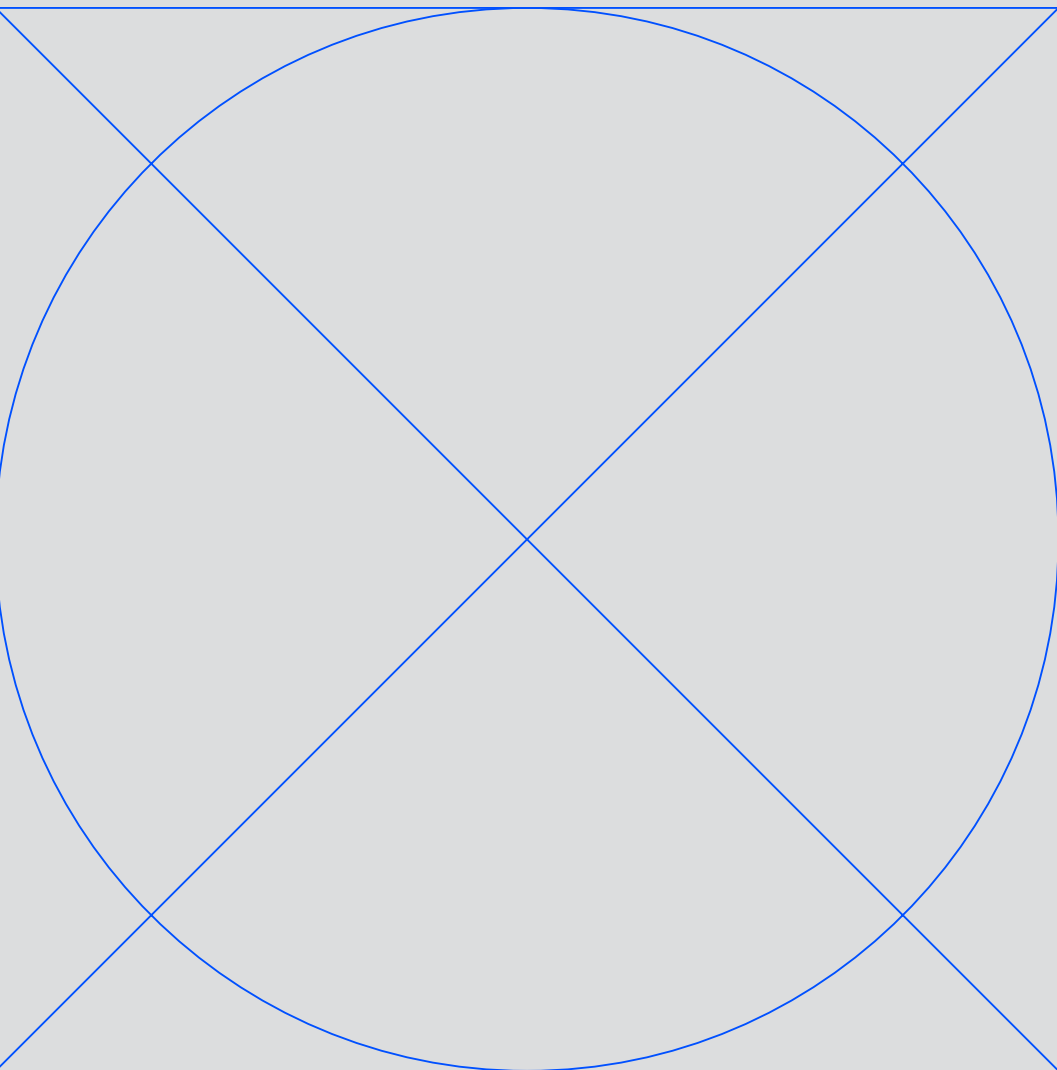

Redo

992

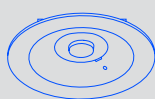

Deco

997

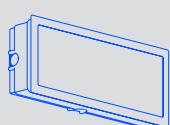

Flag

1003

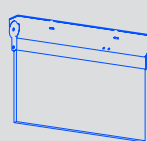

Star

1003

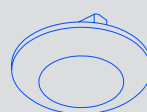

Deco Track

1004

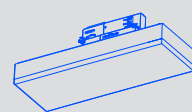

Line

1006

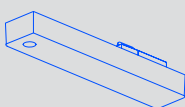

Leco

1008

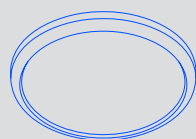

Play

1010

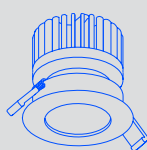

Infinite Pro

1026

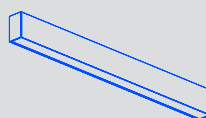

Sia

1038

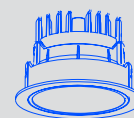

Bento

1032

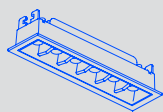

Veo

1043

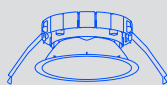

Afrodita

1036

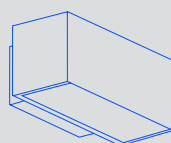

Solid

1037

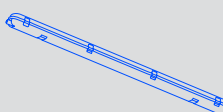

Ecofit

1045

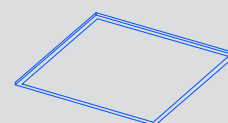



# Iluminación de emergencias

# Iluminação de emergências

La iluminación de emergencia, de la misma forma que la iluminación técnica o decorativa, tiene un papel muy importante en cuanto a la seguridad y el bienestar de las personas. Es un elemento indispensable y obligatorio, que permite guiarnos hacia una evacuación segura en caso de emergencia. Este tipo de luminarias, que entran en funcionamiento cuando las demás dejan de estarlo, se colocan de manera estratégica en edificios tales como centros comerciales, hoteles, hospitales u oficinas. Por ello, escoger una iluminación de emergencia de calidad es un acto de responsabilidad hacia las personas que la utilizan. En LedsC4 estamos comprometidos no solo con las cualidades técnicas y de funcionalidad de éstas, sino que también trabajamos para que irrumpen lo menos posible y se integren perfectamente en cualquier espacio.

La iluminación de emergencia, de la misma forma que la iluminación técnica o decorativa, tiene un papel muy importante en cuanto a la seguridad y el bienestar de las personas. Es un elemento indispensable y obligatorio, que permite guiarnos hacia una evacuación segura en caso de emergencia. Este tipo de luminarias, que entran en funcionamiento cuando las demás dejan de estarlo, se colocan de manera estratégica en edificios tales como centros comerciales, hoteles, hospitales u oficinas. Por ello, escoger una iluminación de emergencia de calidad es un acto de responsabilidad hacia las personas que la utilizan. En LedsC4 estamos comprometidos no solo con las cualidades técnicas y de funcionalidad de éstas, sino que también trabajamos para que irrumpen lo menos posible y se integren perfectamente en cualquier espacio.

La iluminación de emergencia tiene un papel muy importante en cuanto a la seguridad y el bienestar de las personas.

A iluminação de emergência tem um papel muito importante na segurança e no bem-estar das pessoas.



# Tipología de luminarias de emergencia

## Tipologia de luminárias de emergência

LedsC4 ofrece dos tipologías de luminarias de emergencia:

luminarias de emergencia y luminarias técnicas de emergencia. Mientras las primeras son soluciones estándares, las segundas añan prestaciones técnicas con las propias de la iluminación de emergencia. Con ello se consigue ofrecer un producto más versátil que permite integrarse en cualquier proyecto, cumpliendo con la normativa y sin irrumpir estéticamente en el espacio.

A LedsC4 oferece duas tipologias de luminárias de emergência: luminárias de emergência e luminárias técnicas de emergência. Enquanto as primeiras são soluções standard, as últimas combinam prestações técnicas com as próprias da iluminação de emergência. Com isso, é possível oferecer um produto mais versátil que permita a sua integração em qualquer projeto, cumprindo com a regulamentação e sem irromper esteticamente no espaço.

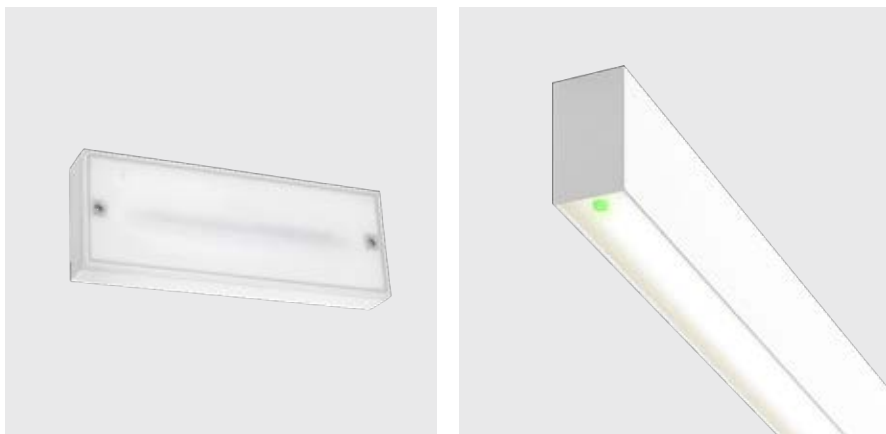

Manusa, Polinyà (Barcelona)  
Fotógrafo: Enric Badrinas

## Modo permanente y no permanente

## Modo permanente e não permanente

En el modo permanente la fuente de luz está constantemente activa tanto con suministro eléctrico como sin él. El modo no permanente, en cambio, la fuente de luz permanece en estado de alerta, en apagado, hasta que se produce el fallo del suministro eléctrico, momento en el cual se encienden.

No modo permanente, a fonte de luz está constantemente ativa tanto com fornecimento elétrico como sem ele. O modo não permanente, pelo contrário, a fonte de luz permanece em estado de alerta quando desligado até ao momento da falha do fornecimento elétrico, momento em que se acende.

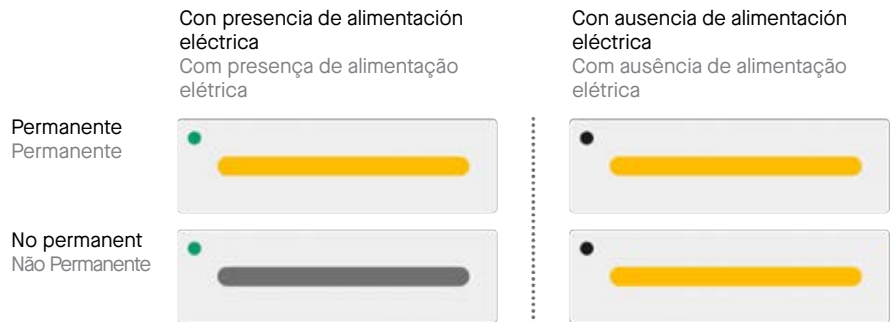

## Modo autotest

## Modo autoteste

Las luminarias con el modo autotest son capaces de realizar un chequeo autónomo periódicamente de su estado y de su batería, para garantizar su estado y representarlo a través de su LED de señalización. Realizan una prueba de función cada 30 días y una de duración cada 52 semanas.

As luminárias com o modo autoteste são capazes de realizar periodicamente uma verificação autónoma do seu estado e da sua bateria, para garantir o seu estado e para o exibi-lo através do seu LED de sinalização. Realizam um teste de função a cada 30 dias e uma de duração a cada 52 semanas.

**La prueba de función** simula durante 2 minutos un fallo de red y comprueba que la luminaria de emergencia funciona correctamente.

**La prueba de duración** simula un fallo de red de 1 hora o 3 horas para comprobar la duración de la batería.

**O teste de função** simula uma falha de rede durante 2 minutos e verifica se a luminária de emergência funciona corretamente.

**O teste de duração** simula uma falha de rede de 1 hora ou 3 horas para verificar a duração da bateria.

LED	Estado	Indicación de fallo Indicação de falha
● Verde sólido Verde sólido	Apagado Desligado	
● Verde intermitente ○ Verde intermitente	Intermitente lento Intermitente lento	Test de funcionamiento de 2 min. Teste de funcionamento de 2min
	Intermitente rápido Intermitente rápido	Test de duración de 1 hora Teste de duração de 1 hora
● Rojo intermitente ○ Vermelho intermitente	1 parpadeos / cintilações	Fallo de batería Falha de batería
	2 parpadeos / cintilações	Fallo de bombilla Falha de lâmpada
	3 parpadeos / cintilações	Fallo de la prueba de duración Falha do teste de duração
● Verde sólido Verde sólido	Red encendida Rede ligada	Sin fallos Sem falhas
○ Verde apagado Verde desligado	Fallo Falha	Comprobar batería Verificar batería

# Monitorización del estado de las luminarias

## Monitorização do estado das luminárias

Permite comprobar y obtener información sobre su funcionamiento, lo que posibilita anticipar y prever cuando requieren de mantenimiento. Con estos sistemas se dispone de información acerca del estado de la batería y de su carga, de datos de la instalación y del estado de emergencia.

Permite verificar e obter informação sobre o seu funcionamento, tornando possível antecipar e prever quando necessitam de manutenção. Graças a estes sistemas está disponível informação sobre o estado da bateria e da sua carga, dados da instalação e do estado de emergência.

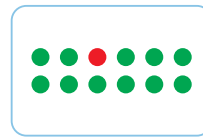
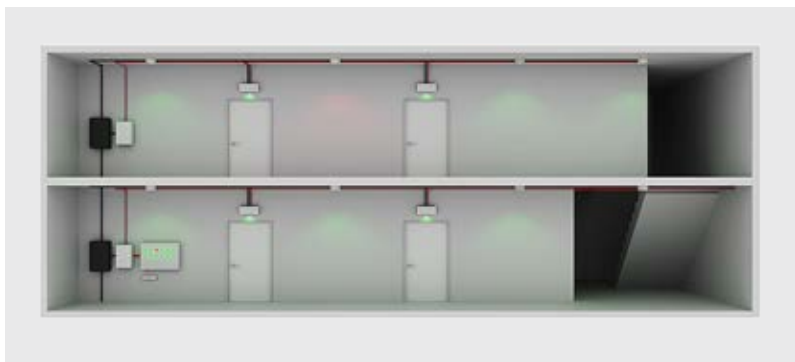

### Sistemas DALI

### Sistemas DALI

Un sistema de control DALI, conectado y cableado a las luminarias de emergencia DALI, favorece la comprobación remota y evita realizar una comprobación visual de los LEDs de señalización.

Um sistema de controlo DALI, ligado por cabo às luminárias de emergência DALI, facilita a monitorização remota e evita uma verificação visual dos LEDs de sinalização.

### Wireless

### Casambi

Un sistema de control DALI, conectado y cableado a las luminarias de emergencia DALI, favorece la comprobación remota y evita realizar una comprobación visual de los LEDs de señalización.

Um sistema de controlo DALI, ligado por cabo às luminárias de emergência DALI, facilita a monitorização remota e evita uma verificação visual dos LEDs de sinalização.

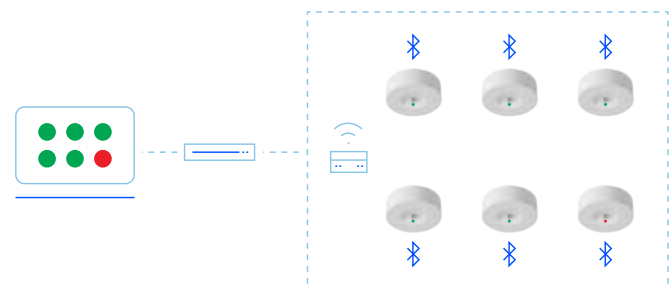
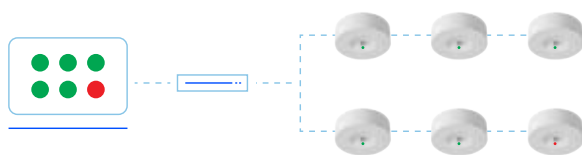





# Redo



Colección de downlights de emergencia de diseño simple y líneas puras en versión empotrable y superficie. Permite una integración total en el espacio con su versión empotrable, que pasa desapercibida en el ambiente gracias a que su punto de luz se encuentra retranqueado, mejorando así el confort visual. Pensada para espacios tales como hoteles, pasillos, residencias y oficinas.

Coleção de downlights de emergência de design simples e linhas puras na versão encastrável e superfície. Permite uma integração total no espaço com a sua versão encastrável, que passa despercebida no ambiente graças ao seu ponto de luz encastrado, melhorando assim o conforto visual. Pensada para espaços como hotéis, corredores, residências e escritórios.







**Lente estándar:** ofrece una alta uniformidad, ideal para espacios cuadrados y zonas abiertas.

**Lente estándar:** oferece uma alta uniformidade, ideal para espaços quadrados e zonas abertas.

**Lente corredor:** ideal para espacios largos como pasillos. Gran interdistancias entre luminarias.

**Lente corredor:** ideal para espaços compridos como corredores. Grande interdistâncias entre luminárias.

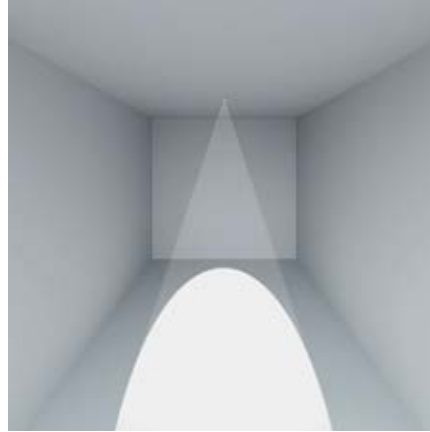
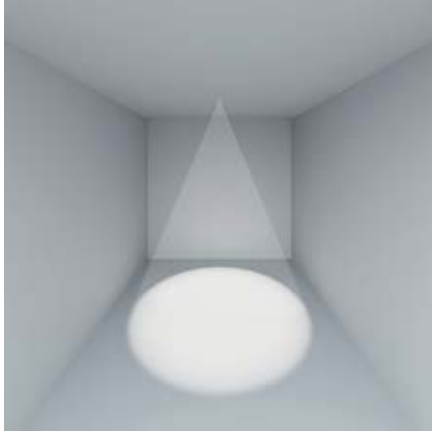

## Monitorización DALI

Controlador de la luminaria a tiempo real.  
Controlador da luminária em tempo real.

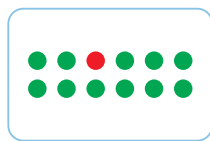
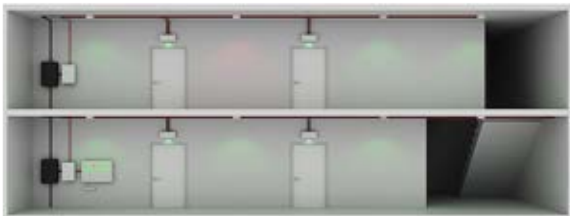

## Versatilidad de instalación

Versatilidade da instalação



BODY MAT	DIF MAT		50000h	3
PC	PC		L80 B20	MacAdam

## Redo Recessed

IP	IK	UGR			
20	10	<10			

○ ●  
14 60



70 0-15 mm

### LED | Real Lm 276

Real Lm. Em	Optics	H. emerg.	Perma- emerg.	Auto- test	Code	
276	29°	1	Yes	No	<b>EM04-0200PN1400</b>	ON-OFF 220-240V
276	29°	1	Yes	Yes	<b>EM04-0200PA1400</b>	ON-OFF 220-240V
276	29°	1	Yes	No	<b>EM04-0200PN6000</b>	ON-OFF 220-240V
276	29°	1	Yes	Yes	<b>EM04-0200PA6000</b>	ON-OFF 220-240V
276	29°	1	Yes	Yes	<b>EM04-0200PA1401</b>	DALI 220-240V
276	29°	1	Yes	Yes	<b>EM04-0200PA6001</b>	DALI 220-240V
276	29°	3	Yes	No	<b>EM04-0203PN1400</b>	ON-OFF 220-240V
276	29°	3	Yes	Yes	<b>EM04-0203PA1400</b>	ON-OFF 220-240V
276	29°	3	Yes	No	<b>EM04-0203PN6000</b>	ON-OFF 220-240V
276	29°	3	Yes	Yes	<b>EM04-0203PA6000</b>	ON-OFF 220-240V
276	29°	3	Yes	Yes	<b>EM04-0203PA1401</b>	DALI 220-240V
276	29°	3	Yes	Yes	<b>EM04-0203PA6001</b>	DALI 220-240V

## Redo Surface

IP	IK	UGR		
20	10	<10		

○ ●  
14 60

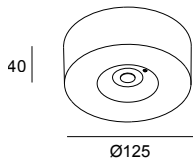

### LED | Real Lm 276

Real Lm. Em	Optics	H. emerg.	Perma- emerg.	Auto- test	Code	
276	29°	3	Yes	Yes	<b>EM05-0203PA1400</b>	ON-OFF 220-240V
276	29°	3	Yes	No	<b>EM05-0203PN1400</b>	ON-OFF 220-240V
276	29°	3	Yes	No	<b>EM05-0203PN6000</b>	ON-OFF 220-240V
276	29°	3	Yes	Yes	<b>EM05-0203PA6000</b>	ON-OFF 220-240V
276	29°	3	Yes	Yes	<b>EM05-0203PA1401</b>	DALI 220-240V
276	29°	3	Yes	Yes	<b>EM05-0203PA6001</b>	DALI 220-240V

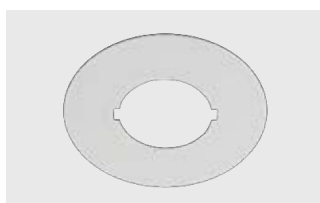

Accesorio adaptador. Para huecos previos en el techo de 140 mm.  
Acessório adaptador. Para furos prévios no teto de 140 mm.



Accesorio tipo bandera para guiado en la evacuación.  
Acessório tipo bandeira para orientação na evacuação.

## Accesorios de fijación

### Acessórios de fixação



Adaptador de diámetro Blanco Redo  
Adaptador de diámetro Branco Redo

EM04-0001



Adaptador de diámetro Negro Redo  
Adaptador de diámetro Preto Redo

EM04-0003

## Accesorios decorativos

### Acessórios decorativos



Accesorio Redo pictograma empotrado  
Acessório Redo pictograma recesso

EM04-0002

#### Redo IP44 NiCD



#### Redo IP44 NiMH



## Accesorios de fijación

### Acessórios de fixação



Accesorio empotrar a pared Deco  
Acessório de encastrar na parede Deco

EM01-0002

EM01-0002



Accesorio empotrar DECO  
Acessório de encastrar DECO

EM01-0001

EM01-0001

## Accesorios decorativos

### Acessórios decorativos



Accesorio Deco Antivandálico  
Acessório Deco antivandalismo

EM01-0003

EM01-0003



Pictograma flecha abajo  
Pictograma seta para baixo

EM01-0008

EM01-0008



Pictograma flecha arriba  
Pictograma seta para cima

EM01-0007

EM01-0007



Pictograma flecha derecha  
Pictograma seta para a direita

EM01-0005

EM01-0005



Pictograma flecha izquierda  
Pictograma seta para a esquerda

EM01-0006

EM01-0006



Luminaria de emergencia convencional de instalación en pared o techo, en superficie o empotrada (mediante accesorio). Su forma y acabado hace que pase desapercibida en el entorno.

Luminária de emergência convencional de instalação na parede ou teto, na superfície ou encastrada (mediante acessório). A sua forma e acabamento faz com que passe despercebida no espaço.

## Monitorización DALI Monitorização DALI

Gracias a las versiones DALI se permite la monitorización en tiempo real de su estatus de funcionamiento.

Graças às versões DALI é possível a monitorização em tempo real do seu estado de funcionamento.



Cuenta con formas rectas, limpias y puras, con un acabado texturizado mate para que pase desapercibida en el ambiente.

Possui formas retas, limpas e puras, com um acabamento texturizado mate para passar despercebida no ambiente.



6	Person icon	91	Person icon	96	Handshake icon
7	Person icon	92	Person icon	97	Handshake icon
8	Person icon	93	Person icon	98	Handshake icon
9	Person icon	94	Person icon	99	Person icon
10	Grid icon	95	Grid icon	100	Grid icon



# Diversidad de accesorios

## Diversidade de acessórios



Accesorio de empotrar en pared  
Acessório de encastrar na parede

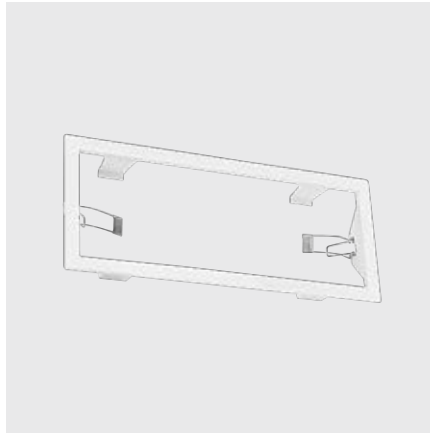

Accesorio de empotrar en techo  
Acessório de encastrar no teto

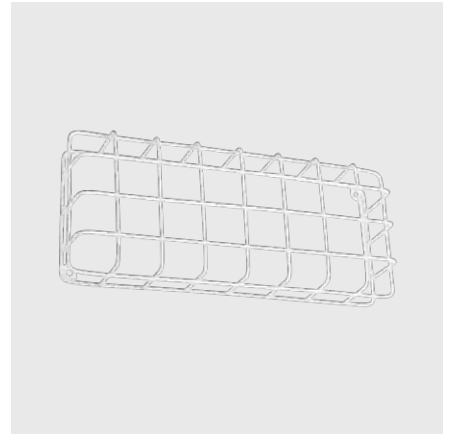

Accesorio antivandálico  
Acessório antivandalismo



Accesorio de señalización  
Acessório de sinalização

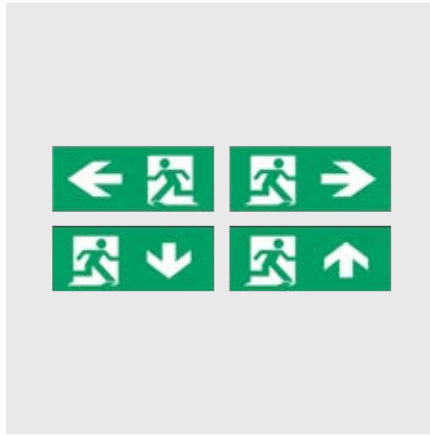

Accesorio pictogramas  
Acessório pictogramas



BODY MAT PC	DIF MAT PC		50000h L80 B20	5 MacAdam
----------------	---------------	------------------------------------------------------------------------------------	-------------------	--------------

## Redo IP44 NiCD

IP 44	IK 10		
----------	----------	-------------------------------------------------------------------------------------	-------------------------------------------------------------------------------------

○  
14

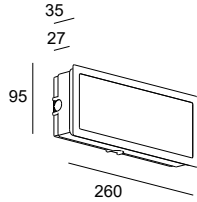



LED						
Real Lm	Real Lm. Em	H. emerg.	Perma-nent	Auto test	Code	
62	62	1	No	No	<b>EM01-0060NN1400</b>	ON-OFF 220-240V
93	93	1	No	No	<b>EM01-0100NN1400</b>	ON-OFF 220-240V
131	131	1	No	No	<b>EM01-0150NN1400</b>	ON-OFF 220-240V
160	160	1	No	No	<b>EM01-0200NN1400</b>	ON-OFF 220-240V
200	200	1	No	No	<b>EM01-0300NN1400</b>	ON-OFF 220-240V
200	200	1	No	No	<b>EM01-0500NN1400</b>	ON-OFF 220-240V
93	93	1	No	Yes	<b>EM01-0100NA1400</b>	ON-OFF 220-240V
160	160	1	No	Yes	<b>EM01-0200NA1400</b>	ON-OFF 220-240V
200	200	1	No	Yes	<b>EM01-0300NA1400</b>	ON-OFF 220-240V
93	93	3	No	No	<b>EM01-0103NN1400</b>	ON-OFF 220-240V
206	160	3	No	No	<b>EM01-0203NN1400</b>	ON-OFF 220-240V
200	200	1	No	Yes	<b>EM01-0300NA1401</b>	DALI 220-240V
103	93	1	Yes	No	<b>EM01-0100PN1400</b>	ON-OFF 220-240V
93	93	3	Yes	No	<b>EM01-0103PN1400</b>	ON-OFF 220-240V
103	93	1	Yes	Yes	<b>EM01-0100PA1400</b>	ON-OFF 220-240V
206	160	1	Yes	Yes	<b>EM01-0200PA1400</b>	ON-OFF 220-240V
206	160	1	Yes	No	<b>EM01-0200PN1400</b>	ON-OFF 220-240V
206	160	3	Yes	No	<b>EM01-0203PN1400</b>	ON-OFF 220-240V
310	200	1	Yes	No	<b>EM01-0300PN1400</b>	ON-OFF 220-240V
310	200	1	Yes	Yes	<b>EM01-0300PA1400</b>	ON-OFF 220-240V
310	200	1	Yes	Yes	<b>EM01-0300PA1401</b>	DALI 220-240V
501	200	1	Yes	No	<b>EM01-0500PN1400</b>	ON-OFF 220-240V

## Redo IP44 NiMH

IP 44	IK 10		
----------	----------	---------------------------------------------------------------------------------------	---------------------------------------------------------------------------------------

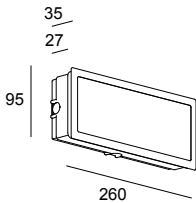
○  
14



LED						
Real Lm	Real Lm. Em	H. emerg.	Perma-nent	Auto test	Code	
200	200	3	No	No	<b>EM01-0303NN1400</b>	ON-OFF 220-240V
200	200	3	No	Yes	<b>EM01-0303NA1400</b>	ON-OFF 220-240V
200	200	3	No	Yes	<b>EM01-0303NA1401</b>	DALI 220-240V
310	200	3	Yes	No	<b>EM01-0303PN1400</b>	ON-OFF 220-240V
310	200	3	Yes	Yes	<b>EM01-0303PA1400</b>	ON-OFF 220-240V
310	200	3	Yes	Yes	<b>EM01-0303PA1401</b>	DALI 220-240V

BODY MAT	DIF MAT		50000h	5
PC	PC		L80 B20	MacAdam

## Deco IP65 Battery NiCD

IP	IK		
65	10		

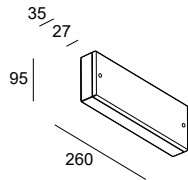

14

LED						
Real Lm	Real Lm. Em	H. emerg.	Perma-nent	Auto test	Code	
62	62	1	No	No	<b>EM02-0060NN1400</b>	ON-OFF 220-240V
92	93	1	No	No	<b>EM02-0100NN1400</b>	ON-OFF 220-240V
131	131	1	No	No	<b>EM02-0150NN1400</b>	ON-OFF 220-240V
160	160	1	No	No	<b>EM02-0200NN1400</b>	ON-OFF 220-240V
200	200	1	No	No	<b>EM02-0300NN1400</b>	ON-OFF 220-240V
200	200	1	No	No	<b>EM02-0500NN1400</b>	ON-OFF 220-240V
93	93	1	No	Yes	<b>EM02-0100NA1400</b>	ON-OFF 220-240V
160	160	1	No	Yes	<b>EM02-0200NA1400</b>	ON-OFF 220-240V
200	200	1	No	Yes	<b>EM02-0300NA1400</b>	ON-OFF 220-240V
93	93	3	No	No	<b>EM02-0103NN1400</b>	ON-OFF 220-240V
160	160	3	No	No	<b>EM02-0203NN1400</b>	ON-OFF 220-240V
200	200	1	No	Yes	<b>EM02-0300NA1401</b>	DALI 220-240V
103	93	1	Yes	No	<b>EM02-0100PN1400</b>	ON-OFF 220-240V
103	93	3	Yes	No	<b>EM02-0103PN1400</b>	ON-OFF 220-240V
103	93	1	Yes	Yes	<b>EM02-0100PA1400</b>	ON-OFF 220-240V
206	160	1	Yes	Yes	<b>EM02-0200PA1400</b>	ON-OFF 220-240V
206	160	1	Yes	No	<b>EM02-0200PN1400</b>	ON-OFF 220-240V
206	160	3	Yes	No	<b>EM02-0203PN1400</b>	ON-OFF 220-240V
310	200	1	Yes	No	<b>EM02-0300PN1400</b>	ON-OFF 220-240V
310	200	1	Yes	Yes	<b>EM02-0300PA1400</b>	ON-OFF 220-240V
310	200	1	Yes	Yes	<b>EM02-0300PA1401</b>	DALI 220-240V
501	200	1	Yes	No	<b>EM02-0500PN1400</b>	ON-OFF 220-240V

## Deco IP65 Battery NiMH

IP	IK		
65	10		

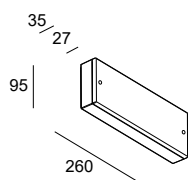

14

LED						
Real Lm	Real Lm. Em	H. emerg.	Perma-nent	Auto test	Code	
200	200	3	No	No	<b>EM02-0303NN1400</b>	ON-OFF 220-240V
200	200	3	No	Yes	<b>EM02-0303NA1400</b>	ON-OFF 220-240V
200	200	3	No	Yes	<b>EM02-0303NA1401</b>	DALI 220-240V
310	200	3	Yes	No	<b>EM02-0303PN1400</b>	ON-OFF 220-240V
310	200	3	Yes	Yes	<b>EM02-0303PA1400</b>	ON-OFF 220-240V
310	200	3	Yes	Yes	<b>EM02-0303PA1401</b>	DALI 220-240V

## Deco IP65 Battery NiCD

## Deco IP65 Battery NiMH

**Accesorios de fijación**  
**Acessórios de fixação**

Accesorio empotrar a pared Deco  
 Acessório de encastrar na parede Deco

EM01-0002

EM01-0002

**Accesorios decorativos**  
**Acessórios decorativos**

Accesorio Deco Antivandálico  
 Acessório Deco antivandalismo

EM01-0003

EM01-0003



Accesorio Señalización Deco  
 Acessório Sinalização Deco

EM02-0004

EM02-0004



Pictograma flecha abajo  
 Pictograma seta para baixo

EM01-0008

EM01-0008



Pictograma flecha arriba  
 Pictograma seta para cima

EM01-0007

EM01-0007



Pictograma flecha derecha  
 Pictograma seta para a direita

EM01-0005

EM01-0005



Pictograma flecha izquierda  
 Pictograma seta para a esquerda

EM01-0006

EM01-0006

# Flag

BODY MAT	DIF MAT		50000h	5
PC	PMMA		L80 B20	MacAdam

IP	UGR	LOW			
20	<13	FLICKER	90°		

14

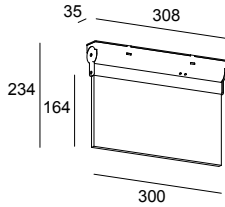

LED   Real Lm 14					
Real Lm.H.	Perma-	Auto test Code			
Em	emerg.	ment			
70	3	Yes/No	Yes	<b>EM03-0103PA1400</b>	ON-OFF 220-240V

# Star

BODY MAT	DIF MAT		50000h	5
PC	PMMA		L80 B20	MacAdam

IP	UGR	LOW			
20	<19	FLICKER			

14

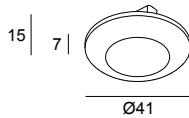

LED   Real Lm 6					
Real Lm.H.	Perma-	Auto test Code			
Em	emerg.	ment			
6	3	No	No	<b>EM06-0006NN1400</b>	ON-OFF 230V

65

# Deco Track



Versión del modelo Deco Track disponible para la instalación en carril trifásico, permitiendo integrar la iluminación de emergencia en arquitecturas donde por la tipología de instalación aparecen los carriles de iluminación.

Versão do modelo Deco Track disponível para a instalação na calha trifásica, permitindo integrar a iluminação de emergência em arquiteturas onde pela tipologia da instalação aparecem as calhas de iluminação.

Monitorización DALI para conocer en tiempo real el estatus de funcionamiento.

Monitorização DALI para conhecer o estado de funcionamento em tempo real.

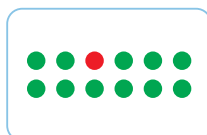

## Deco Track Battery NiCd

IP
20

IK
10



○  
14

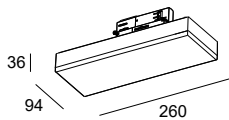

### LED

Real Lm	Real Lm. Em	H. emerg.	Perma-nent	Auto test	Code	
160	160	3	No	No	<b>EM10-0203NN1400</b>	ON-OFF 220-240V
93	93	3	No	No	<b>EM10-0103NN1400</b>	ON-OFF 220-240V
93	93	3	No	Yes	<b>EM10-0103NN1401</b>	DALI 220-240V
160	160	3	No	Yes	<b>EM10-0203NN1401</b>	DALI 220-240V
103	93	3	Yes	No	<b>EM10-0103PN1400</b>	ON-OFF 220-240V
103	93	3	Yes	Yes	<b>EM10-0103PN1401</b>	DALI 220-240V
206	160	3	Yes	No	<b>EM10-0203PN1400</b>	ON-OFF 220-240V
206	160	3	Yes	Yes	<b>EM10-0203PN1401</b>	DALI 220-240V

## Deco Track Battery NiMH

IP
20

IK
10



○ ●  
14 60

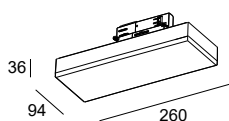

### LED

Real Lm	Real Lm. Em	H. emerg.	Perma-nent	Auto test	Code	
200	200	3	No	No	<b>EM10-0303NN1400</b>	ON-OFF 220-240V
200	200	3	No	Yes	<b>EM10-0303NA1400</b>	ON-OFF 220-240V
200	200	3	No	Yes	<b>EM10-0303NN1401</b>	DALI 220-240V
310	200	3	Yes	No	<b>EM10-0303PN1400</b>	ON-OFF 220-240V
310	200	3	Yes	Yes	<b>EM10-0303PA1400</b>	ON-OFF 220-240V
310	200	3	Yes	Yes	<b>EM10-0303PN1401</b>	DALI 220-240V

### Deco Track Battery NiCd

### Deco Track Battery NiMH



## Accesorios decorativos Acessórios decorativos



Accesorio Señalización Deco  
Acessório Sinalização Deco

EM02-0004

EM02-0004



Pictograma flecha abajo  
Pictograma seta para baixo

EM01-0008

EM01-0008



Pictograma flecha arriba  
Pictograma seta para cima

EM01-0007

EM01-0007



Pictograma flecha derecha  
Pictograma seta para a direita

EM01-0005

EM01-0005



Pictograma flecha izquierda  
Pictograma seta para a esquerda

EM01-0006

EM01-0006

# Line

Luminaria de emergencia totalmente integrable en el carril trifásico. Permite integrar la iluminación de emergencia en arquitecturas donde, por la tipología de instalación, aparecen los carriles de iluminación.

Luminária de emergência totalmente integrável na calha trifásica. Permite a integração da iluminação de emergência em arquiteturas onde, pela tipologia da instalação, aparecem as calhas de iluminação.



## Monitorización DALI

## Monitorização DALI

Las versiones DALI permiten la monitorización en tiempo real de su estatus de funcionamiento.

As versões DALI permitem a monitorização em tempo real do seu estado de funcionamento.





# Line

BODY MAT
PC

DIF MAT
AL



50000h
L80 B20

4
MacAdam

IP
20

IK
10



○ ●  
14 60

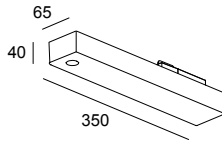
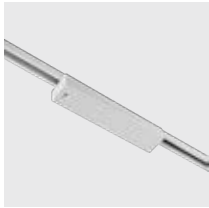

LED   Real Lm 89					
Real Lm.H.	Perma-	Auto test Code			
Em	emerg.	nent			
90	3	No	No	<b>EM08-0203NA1400</b>	ON-OFF 220-240V
90	3	No	No	<b>EM08-0203NA6000</b>	ON-OFF 220-240V
90	3	No	Yes	<b>EM08-0203NA1401</b>	DALI 220-240V
90	3	No	Yes	<b>EM08-0203NA6001</b>	DALI 220-240V

# Leco



Leco es una luminaria de emergencia de superficie, ideal para la iluminación de zonas de paso tales como pasillos o zonas comunes. Su cuerpo incorpora un tratamiento especial UV que evita el amarillamiento de los materiales y asegura un perfecto estado durante más tiempo. Esta luminaria puede utilizarse en su funcionamiento estándar y en emergencia cuando se produzca cualquier fallo eléctrico.

Leco é uma luminária de emergência de superfície, ideal para iluminar zonas de passagem como corredores ou zonas comuns. O seu corpo incorpora um tratamento especial UV que evita o amarelecimento dos materiais e assegura um perfeito estado durante mais tempo. Esta luminária pode ser utilizada no seu funcionamento standard e em emergência quando ocorra qualquer falha elétrica.

LED indicador localizado en el lateral de la luminaria  
LED indicador localizado na lateral da luminária



Monitorización DALI  
Monitorização DALI

Permite la monitorización en tiempo real del estatus de funcionamiento.

Permite a monitorização em tempo real do estado de funcionamento.



BODY MAT	DIF MAT		50000h	3
PC	PC		L80 B20	MacAdam

FAMILIA/FAMÍLIA: Leco Standard P.XXX

IP	IK	LOW		
44	10	FLICKER		

14

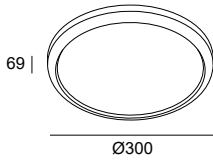

LED   Real Lm 911					
Real Lm.H.	Perma-	Auto test Code			
Em	emerg.	ment			
113	3	Yes	No	<b>15-A003-14-OE</b>	ON-OFF 220-240V

IP	IK	LOW		
44	10	FLICKER		

14

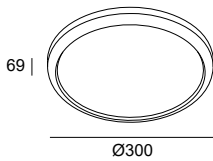

LED   Real Lm 911					
Real Lm.H.	Perma-	Auto test Code			
Em	emerg.	ment			
200	3	Yes	Yes	<b>15-A003-14-DE</b>	DALI 220-240V

# Play

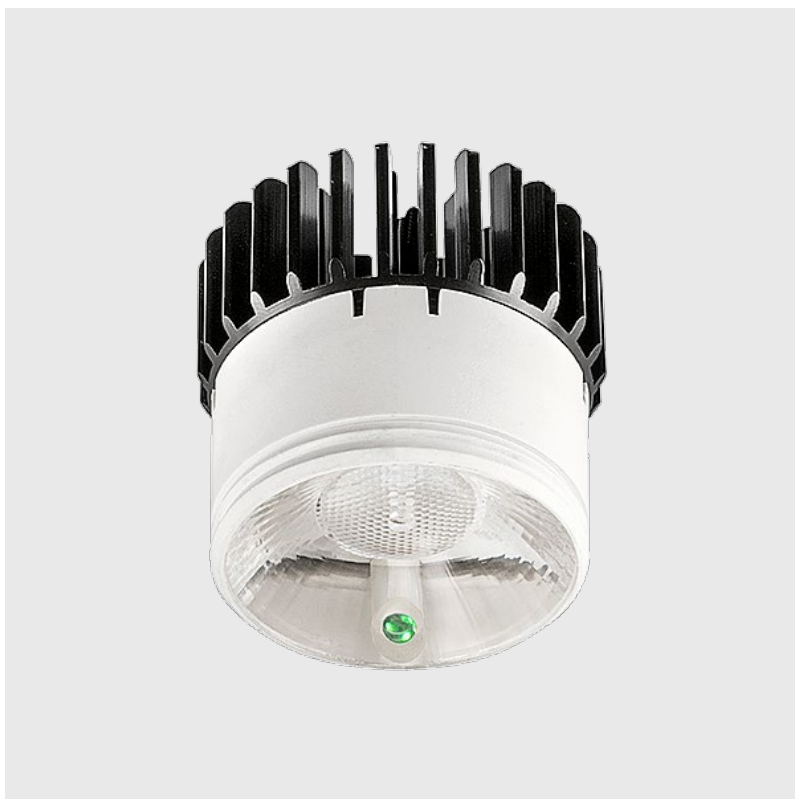

Colección de downlights con una gran modularidad y prestaciones. Ambas, tanto la versión estándar como la de emergencias permiten añadir y combinar un módulo LED con una gran variedad de marcos y accesorios, obteniendo un downlight a medida adaptado a las necesidades de cada proyecto.

Coleção de downlights com uma grande modularidade e prestações. Ambas, tanto na versão standard como na de emergência, permitem adicionar e combinar um módulo LED com uma grande variedade de aros e acessórios, obtendo um downlight à medida adaptado às necessidades de cada projeto.

Sistema de señalización del estatus de la luminaria patentado por LEDS C4 con el indicador de emergencia incluido en la misma óptica, lo que aporta una mayor homogeneización del proyecto.

Sistema de sinalização do estado da luminária patenteado pela LEDS C4 com o indicador de emergência incluído na mesma ótica, o que proporciona uma maior homogeneização do projeto.

























El Kit autotest DALI permite la monitorización en tiempo real del funcionamiento de las luminarias.

O Kit autoteste DALI permite a monitorização em tempo real do funcionamento das luminárias.

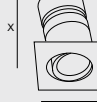
**FAMILIA/FAMÍLIA:** Play Deco Track P.XXX / Play Flat P.XXX / Play Deco Pendant P.XXX / Play Deco Surface P.XXX

Ejemplo de código / Exemplo de código: **AG11-P7V9M20114**

Model	W	K / CRI / Real lm	Optics	Source	Finishes		
 <p><b>AG11 -</b> Redondo / Fijo Redondo / fixo 0-7 mm 58 IP54</p> <p>○ ● 14 60</p> 	<b>P7</b> 8.5W	<p><b>V9</b> 2700K / CRI 90 / 582 lm</p> <p><b>W9</b> 3000K / CRI 90 / 663 lm</p> <p><b>X9</b> 4000K / CRI 90 / 674 lm</p>	<b>M2</b> 28°	<p><b>O1</b>  Emergency ON-OFF 1H 220-240V</p> <p><b>O3</b>  Emergency ON-OFF 3H 220-240V</p> <p><b>D1</b>  Emergency DALI-2 1H 220-240V</p> <p><b>D3</b>  Emergency DALI-2 3H 220-240V</p>	<p><b>14</b> </p> <p><b>60</b> </p> <p><b>AF</b> </p>		
 <p><b>AG12 -</b> Redondo / Ajustable Redondo / ajustável 0-20 mm 68 IP23</p> <p>○ ● ● 14 60 AF</p> 		<b>13</b> 14.3W		<p><b>V9</b> 2700K / CRI 90 / 960 lm</p> <p><b>W9</b> 3000K / CRI 90 / 1305 lm</p> <p><b>X9</b> 4000K / CRI 90 / 1397 lm</p>		<b>M2</b> 34°	<p><b>O1</b>  Emergency ON-OFF 1H 220-240V</p> <p><b>O3</b>  Emergency ON-OFF 3H 220-240V</p> <p><b>D1</b>  Emergency DALI-2 1H 220-240V</p> <p><b>D3</b>  Emergency DALI-2 3H 220-240V</p>
 <p><b>AG19 -</b> Cuadrado / Fijo Quadrado / fixo 0-7 mm 58 IP54</p> <p>○ ● 14 60</p> 				<b>13</b> 14.3W			<p><b>V9</b> 2700K / CRI 90 / 960 lm</p> <p><b>W9</b> 3000K / CRI 90 / 1305 lm</p> <p><b>X9</b> 4000K / CRI 90 / 1397 lm</p>
 <p><b>AG21 -</b> Cuadrado / Ajustable Quadrado / ajustável 0-20 mm 68 IP23</p> <p>○ ● 14 60</p> 	<p><b>V9</b> 2700K / CRI 90 / 960 lm</p> <p><b>W9</b> 3000K / CRI 90 / 1305 lm</p> <p><b>X9</b> 4000K / CRI 90 / 1397 lm</p>		<p><b>O1</b>  Emergency ON-OFF 1H 220-240V</p> <p><b>O3</b>  Emergency ON-OFF 3H 220-240V</p> <p><b>D1</b>  Emergency DALI-2 1H 220-240V</p> <p><b>D3</b>  Emergency DALI-2 3H 220-240V</p>				

Play Flat 7W Emergency

Play Flat 13W Emergency



## Accesorios ópticos

### Acessórios óticos



Difuminador de halo (5u.)  
Difusor opalino (5u.)

71-6099-00-00

71-6099-00-00



Confort visual (1u.)  
Conforto visual (1u.)

14 ○

71-4754-14-00

71-4754-14-00

60 ●

71-4754-60-00

71-4754-60-00



Apantallador (5u.)  
Obturador assimetrico (5u.)

60 ●

71-7895-60-00

71-7895-60-00

BODY MAT		50000h	2	IP	IK			
PC,AL		L80 B20	MacAdam	23	03			



**FAMILIA/FAMÍLIA:** Play Deco Track P.XXX / Play Flat P.XXX / Play Deco Pendant P.XXX / Play Deco Surface P.XXX

Ejemplo de código / Exemplo de código: **AG15-P7V9M20114**

Model	W	K / CRI / Real lm	Optics	Source	Finishes
 <b>AG15 -</b> Redondo / Fijo Redondo / fixo Ø 0-20 mm Ⓢ 58 IP54 	<b>P7</b> 8.5W	<b>V9</b> 2700K / CRI 90 / 543 lm	<b>M2</b> 27°	<b>O1</b> Emergency ON-OFF 1H 220-240V	<b>14</b> <b>60</b>
		<b>W9</b> 3000K / CRI 90 / 548 lm		<b>O3</b> Emergency ON-OFF 3H 220-240V	
		<b>X9</b> 4000K / CRI 90 / 628 lm		<b>D1</b> Emergency DALI-2 1H 220-240V <b>D3</b> Emergency DALI-2 3H 220-240V	
 <b>AG17 -</b> Redondo / Ajustable / Sin marco Redondo / ajustável / trimless Ø 0-18 mm Ⓢ 75 IP23 	<b>13</b> 14.3W	<b>V9</b> 2700K / CRI 90 / 1110 lm	<b>M2</b> 33°	<b>O1</b> Emergency ON-OFF 1H 220-240V	
		<b>W9</b> 3000K / CRI 90 / 1195 lm		<b>O3</b> Emergency ON-OFF 3H 220-240V	
		<b>X9</b> 4000K / CRI 90 / 1278 lm		<b>D1</b> Emergency DALI-2 1H 220-240V <b>D3</b> Emergency DALI-2 3H 220-240V	

Play Depp 7W Emergency

Play Depp 13W Emergency



## Accesorios ópticos Acessórios óticos

	Difuminador de halo (5u.) Difusor opalino (5u.)		<b>71-6099-00-00</b>	<b>71-6099-00-00</b>
	Confort visual (1u.) Conforto visual (1u.)	14	<b>71-4754-14-00</b>	<b>71-4754-14-00</b>
		60	<b>71-4754-60-00</b>	<b>71-4754-60-00</b>
	Apantallador (5u.) Obturador assimétrico (5u.)	60	<b>71-7895-60-00</b>	<b>71-7895-60-00</b>





# Play

## High Visual Comfort Emergency

BODY MAT PC,AL		50000h L80 B20	2 MacAdam	IP 23	IK 03			
-------------------	--	-------------------	--------------	----------	----------	--	--	--

**FAMILIA/FAMÍLIA:** Play Deco Track P.XXX / Play Flat P.XXX / Play Deco Pendant P.XXX / Play Deco Surface P.XXX

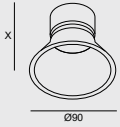
Ejemplo de código / Exemplo de código: **AG13-P7V9M20114**

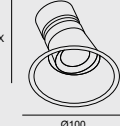
Model	W	K / CRI / Real lm	Optics	Source	Finishes
 <b>AG13 - Redondo / Fijo</b> Redondo / fixo Ø 0-25 mm Ⓢ 78 IP54 	<b>P7</b> 8.5W	<b>V9</b> 2700K / CRI 90 / 565 lm	<b>M2</b> 28°	<b>O1</b> Emergency ON-OFF 1H 220-240V	<b>14</b> <b>60</b>
		<b>W9</b> 3000K / CRI 90 / 606 lm		<b>O3</b> Emergency ON-OFF 3H 220-240V	
		<b>X9</b> 4000K / CRI 90 / 626 lm		<b>D1</b> Emergency DALI-2 1H 220-240V	
 <b>AG14 - Redondo / Ajustable</b> Redondo / ajustável Ø 0-18 mm Ⓢ 90 IP23 	<b>13</b> 14.3W	<b>V9</b> 2700K / CRI 90 / 1216 lm	<b>M2</b> 34°	<b>O1</b> Emergency ON-OFF 1H 220-240V	
		<b>W9</b> 3000K / CRI 90 / 1216 lm		<b>O3</b> Emergency ON-OFF 3H 220-240V	
		<b>X9</b> 4000K / CRI 90 / 1302 lm		<b>D1</b> Emergency DALI-2 1H 220-240V	
				<b>D3</b> Emergency DALI-2 3H 220-240V	



**Play High Visual Comfort 7W Emergency**



**Play High Visual Comfort 13W Emergency**









**Accesorios ópticos**  
Acessórios óticos

	Difuminador de halo (5u.) Difusor opalino (5u.)		<b>71-6099-00-00</b>	<b>71-6099-00-00</b>
	Confort visual (1u.) Conforto visual (1u.)	14 ○	<b>71-4754-14-00</b>	<b>71-4754-14-00</b>
		60 ●	<b>71-4754-60-00</b>	<b>71-4754-60-00</b>
	Apantallador (5u.) Obturador assimetrico (5u.)	60 ●	<b>71-7895-60-00</b>	<b>71-7895-60-00</b>



**FAMILIA/FAMÍLIA:** Play Deco Track P.XXX / Play Flat P.XXX / Play Deco Pendant P.XXX / Play Deco Surface P.XXX

Ejemplo de código / Exemplo de código: **AG16-P7V9M20114**







Model	W	K / CRI / Real lm	Optics	Source	Finishes
 <p><b>AG16 -</b> Redondo / Fijo Redondo / fixo 0-20 mm 65 IP65</p> <p>14 60 21</p> 	<b>P7</b> 8.5W	<b>V9</b> 2700K / CRI 90 / 543 lm	<b>M2</b> 28°	<b>O1</b>  Emergency ON-OFF 1H 220-240V	<b>14</b>  <b>60</b>  <b>21</b> 
		<b>W9</b> 3000K / CRI 90 / 595 lm		<b>O3</b>  Emergency ON-OFF 3H 220-240V	
		<b>X9</b> 4000K / CRI 90 / 629 lm		<b>D1</b>  Emergency DALI-2 1H 220-240V <b>D3</b>  Emergency DALI-2 3H 220-240V	
 <p><b>AG22 -</b> Cuadrado / Fijo Quadrado / fixo 0-20 mm 65 IP65</p> <p>14 60</p> 	<b>13</b> 14.3W	<b>V9</b> 2700K / CRI 90 / 1161 lm	<b>M2</b> 34°	<b>O1</b>  Emergency ON-OFF 1H 220-240V	
		<b>W9</b> 3000K / CRI 90 / 1161 lm		<b>O3</b>  Emergency ON-OFF 3H 220-240V	
		<b>X9</b> 4000K / CRI 90 / 1242 lm		<b>D1</b>  Emergency DALI-2 1H 220-240V <b>D3</b>  Emergency DALI-2 3H 220-240V	

**Play IP65 7W Emergency**

**Play IP65 13W Emergency**



**Accesorios ópticos**  
Acessórios óticos

	Difuminador de halo (5u.) Difusor opalino (5u.)		<b>71-6099-00-00</b>	<b>71-6099-00-00</b>
	Confort visual (1u.) Conforto visual (1u.)	14 	<b>71-4754-14-00</b>	<b>71-4754-14-00</b>
		60 	<b>71-4754-60-00</b>	<b>71-4754-60-00</b>
	Apantallador (5u.) Obturator assimetrico (5u.)	60 	<b>71-7895-60-00</b>	<b>71-7895-60-00</b>

# Play

## IP65 Glass Emergency

BODY MAT
PC,AL



50000h
L80 B20

2
MacAdam

IP
65

IK
03

DIF MAT
GLA



FAMILIA/FAMÍLIA: Play Deco Track P.XXX / Play Flat P.XXX / Play Deco Pendant P.XXX / Play Deco Surface P.XXX

Ejemplo de código / Exemplo de código: **AG43-P7V9M20114**

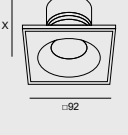
Model	W	K / CRI / Real lm	Optics	Source	Finishes
 <p><b>AG43 -</b> Redondo / Fijo Redondo / fixo Ø 0-20 mm Ⓢ 68 IP65</p> 	P7 8.5W	V9 2700K / CRI 90 / 514 lm	M2 28°	O1  Emergency ON-OFF 1H 220-240V	14 
		W9 3000K / CRI 90 / 595 lm		O3  Emergency ON-OFF 3H 220-240V	
		X9 4000K / CRI 90 / 595 lm		D1  Emergency DALI-2 1H 220-240V	
 <p><b>AG44 -</b> Cuadrado / Fijo Cuadrado / fixo Ø 0-20 mm Ⓢ 68 IP65</p> 	13 14.3W	V9 2700K / CRI 90 / 922 lm	M2 34°	O1  Emergency ON-OFF 1H 220-240V	
		W9 3000K / CRI 90 / 1176 lm		O3  Emergency ON-OFF 3H 220-240V	
		X9 4000K / CRI 90 / 1258 lm		D1  Emergency DALI-2 1H 220-240V	
				D3  Emergency DALI-2 3H 220-240V	

### Accesorios ópticos

#### Acessórios óticos



Difuminador de halo (5u.)  
Difusor opalino (5u.)

**71-6099-00-00**

Confort visual (1u.)  
Conforto visual (1u.)

14 ○

**71-4754-14-00**



60 ●

**71-4754-60-00**



Apantallador (5u.)  
Obturador assimétrico (5u.)

60 ●

**71-7895-60-00**

BODY MAT
PC,AL



50000h
L80 B20

2
MacAdam











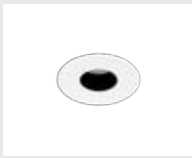
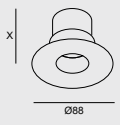

IP
23

IK
03

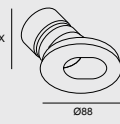

**FAMILIA/FAMÍLIA:** Play Deco Track P.XXX / Play Flat P.XXX / Play Deco Pendant P.XXX / Play Deco Surface P.XXX

Ejemplo de código / Exemplo de código: **AG45-P7V9M20114**

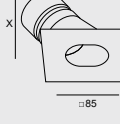
Model	W	K / CRI / Real lm	Optics	Source	Finishes
 <p><b>AG45 -</b> Redondo / Fijo Redondo / fixo ☞ 0-18 mm Ⓢ 75 IP54</p> 	<b>P7</b> 8.5W	<b>V9</b> 2700K / CRI 90 / 304 lm	<b>M2</b> 32°	<b>O1</b>  Emergency ON-OFF 1H 220-240V	<b>14</b> 
		<b>W9</b> 3000K / CRI 90 / 364 lm		<b>O3</b>  Emergency ON-OFF 3H 220-240V	
		<b>X9</b> 4000K / CRI 90 / 368 lm		<b>D1</b>  Emergency DALI-2 1H 220-240V  <b>D3</b>  Emergency DALI-2 3H 220-240V	
 <p><b>AG46 -</b> Cuadrado / Fijo Cuadrado / fixo ☞ 0-18 mm Ⓢ 75 IP54</p> 	<b>13</b> 14.3W	<b>V9</b> 2700K / CRI 90 / 1070 lm	<b>M2</b> 32°	<b>O1</b>  Emergency ON-OFF 1H 220-240V	
		<b>W9</b> 3000K / CRI 90 / 1138 lm		<b>O3</b>  Emergency ON-OFF 3H 220-240V	
		<b>X9</b> 4000K / CRI 90 / 1230 lm		<b>D1</b>  Emergency DALI-2 1H 220-240V  <b>D3</b>  Emergency DALI-2 3H 220-240V	
 <p><b>AG47 -</b> Redondo / Ajustable Redondo / ajustável ☞ 0-18 mm Ⓢ 75 IP23</p> 					
 <p><b>AG48 -</b> Cuadrado / ajustable Cuadrado / ajustável ☞ 0-18 mm Ⓢ 75 IP23</p> 					

Play Pinhole 7W Emergency

Play Pinhole 13W  
Emergency



**Accesorios ópticos**  
Acessórios óticos



Difuminador de halo (5u.)  
Difusor opalino (5u.)

**71-6099-00-00**

**71-6099-00-00**



Confort visual (1u.)  
Conforto visual (1u.)

14 ○

**71-4754-14-00**

**71-4754-14-00**

60 ●

**71-4754-60-00**

**71-4754-60-00**



Apantallador (5u.)  
Obturador assimetrico (5u.)

60 ●

**71-7895-60-00**

**71-7895-60-00**



**FAMILIA/FAMÍLIA:** Play Deco Track P.XXX / Play Flat P.XXX / Play Deco Pendant P.XXX / Play Deco Surface P.XXX

Ejemplo de código / Exemplo de código: **AG52-P7V9M20114**



Model	W	K / CRI / Real lm	Optics	Source	Finishes
 <p><b>AG52 -</b> Redondo / Ajustable Redondo / ajustável ☞ 0-18 mm Ⓢ 86 IP23</p>  <p>Ø95</p>	<b>P7</b> 8.5W	<b>V9</b> 2700K / CRI 90 / 332 lm	<b>M2</b> 33°	<b>O1</b>  Emergency ON-OFF 1H 220-240V	<b>14</b>  <b>60</b> 
		<b>W9</b> 3000K / CRI 90 / 386 lm		<b>O3</b>  Emergency ON-OFF 3H 220-240V	
		<b>X9</b> 4000K / CRI 90 / 504 lm		<b>D1</b>  Emergency DALI-2 1H 220-240V	
 <p><b>AG53 -</b> Redondo / Ajustable / Sin marco Redondo / ajustável</p>  <p>Ø95</p>	<b>13</b> 14.3W	<b>V9</b> 2700K / CRI 90 / 900 lm	<b>M2</b> 34°	<b>O1</b>  Emergency ON-OFF 1H 220-240V	<b>14</b>  <b>60</b> 
		<b>W9</b> 3000K / CRI 90 / 1271 lm		<b>O3</b>  Emergency ON-OFF 3H 220-240V	
		<b>X9</b> 4000K / CRI 90 / 1360 lm		<b>D1</b>  Emergency DALI-2 1H 220-240V	
 <p><b>AG55 -</b> Cuadrado / ajustable Quadrado / ajustável ☞ 0-18 mm Ⓢ 85×85 IP23</p>  <p>85</p>				<b>D3</b>  Emergency DALI-2 3H 220-240V	

Play Soft 7W Emergency

Play Soft 13W Emergency



## Accesorios ópticos Acessórios óticos

	Difuminador de halo (5u.) Difusor opalino (5u.)		<b>71-6099-00-00</b>	<b>71-6099-00-00</b>
	Confort visual (1u.) Conforto visual (1u.)	14 ○	<b>71-4754-14-00</b>	<b>71-4754-14-00</b>
		60 ●	<b>71-4754-60-00</b>	<b>71-4754-60-00</b>
	Apantallador (5u.) Obturador assimetrico (5u.)	60 ●	<b>71-7895-60-00</b>	<b>71-7895-60-00</b>

# Play Snoot Emergency

BODY MAT PC,AL		50000h L80 B20	2 MacAdam	IP 23	IK 03					
-------------------	--	-------------------	--------------	----------	----------	--	--	--	--	--

FAMILIA/FAMÍLIA: Play Deco Track P.XXX / Play Flat P.XXX / Play Deco Pendant P.XXX / Play Deco Surface P.XXX

Ejemplo de código / Exemplo de código: **AG56-P7V9M20114**

Model	W	K / CRI / Real lm	Optics	Source	Finishes	
 <p><b>AG56 -</b> Redondo / Ajustable Redondo / ajustável 0-18 mm 85 IP23 40° ↕ 320°</p>  <p>Ø95</p>	P7 8.5W	V9 2700K / CRI 90 / 507 lm	M2 27°	O1  Emergency ON-OFF 1H 220-240V	14	
		W9 3000K / CRI 90 / 590 lm		O3  Emergency ON-OFF 3H 220-240V		60
		X9 4000K / CRI 90 / 590 lm		D1  Emergency DALI-2 1H 220-240V		D3  Emergency DALI-2 3H 220-240V
 <p><b>AG57 -</b> Redondo / Ajustable / Sin marco Redondo / ajustável / sem aro 0-18 mm 87 IP23 40° ↕ 320°</p>  <p>Ø86</p>	13 14.3W	V9 2700K / CRI 90 / 1131 lm	M2 34°	O1  Emergency ON-OFF 1H 220-240V		
		W9 3000K / CRI 90 / 1203 lm		O3  Emergency ON-OFF 3H 220-240V		
		X9 4000K / CRI 90 / 1300 lm		D1  Emergency DALI-2 1H 220-240V		D3  Emergency DALI-2 3H 220-240V

Play Snoot 7W Emergency

Play Snoot 13W Emergency



Accesorios ópticos  
Acessórios óticos

	Difuminador de halo (5u.) Difusor opalino (5u.)		71-6099-00-00	71-6099-00-00
	Confort visual (1u.) Conforto visual (1u.)	14 ○	71-4754-14-00	71-4754-14-00
		60 ●	71-4754-60-00	71-4754-60-00
	Apantallador (5u.) Obturador assimetrico (5u.)	60 ●	71-7895-60-00	71-7895-60-00



BODY MAT
PC,AL



50000h
L80 B20

2
MacAdam

IP
54

IK
03



**FAMILIA/FAMÍLIA:** Play Deco Track P.XXX / Play Flat P.XXX / Play Deco Pendant P.XXX / Play Deco Surface P.XXX

Ejemplo de código / Exemplo de código: **AG59-P7V9M20155**

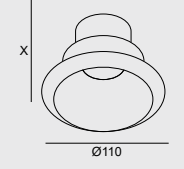
Model	W	K / CRI / Real lm	Optics	Source	Finishes
 <p><b>AG59 -</b> Redondo / Fijo Redondo / fixo 0-25 mm 100 IP54</p> 	<b>P7</b> 8.5W	<b>V9</b> 2700K / CRI 90 / 535 lm	<b>M2</b> 32°	<b>O1</b> Emergency ON-OFF 1H 220-240V	<b>55</b> <b>EN</b> <b>EO</b> <b>DC</b>
		<b>W9</b> 3000K / CRI 90 / 601 lm		<b>O3</b> Emergency ON-OFF 3H 220-240V	
		<b>X9</b> 4000K / CRI 90 / 604 lm		<b>D1</b> Emergency DALI-2 1H 220-240V	
	<b>13</b> 14.3W	<b>V9</b> 2700K / CRI 90 / 1175 lm	<b>M2</b> 34°	<b>D3</b> Emergency DALI-2 3H 220-240V	
		<b>W9</b> 3000K / CRI 90 / 1250 lm		<b>O1</b> Emergency ON-OFF 1H 220-240V	
		<b>X9</b> 4000K / CRI 90 / 1350 lm		<b>O3</b> Emergency ON-OFF 3H 220-240V	
			<b>D1</b> Emergency DALI-2 1H 220-240V		
			<b>D3</b> Emergency DALI-2 3H 220-240V		







Play Raw 7W Emergency

Play Raw 13W Emergency



### Accesorios ópticos

#### Acessórios óticos

	Difuminador de halo (5u.) Difusor opalino (5u.)		<b>71-6099-00-00</b>	<b>71-6099-00-00</b>
	Confort visual (1u.) Conforto visual (1u.)	14 	<b>71-4754-14-00</b>	<b>71-4754-14-00</b>
		60 	<b>71-4754-60-00</b>	<b>71-4754-60-00</b>
	Apantallador (5u.) Obturator assimetrico (5u.)	60 	<b>71-7895-60-00</b>	<b>71-7895-60-00</b>

# Play

## Play Raw Racy Gold Emergency

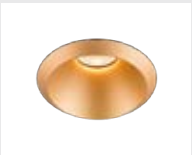
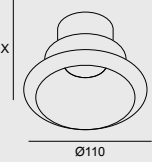

Ejemplo de código / Exemplo de código: **AG58-P7V9M201EP**

Model	W	K / CRI / Real lm	Optics	Source	Finishes
 <p><b>AG58 -</b> Redondo / Fijo Redondo / fixo 0-25 mm 100 IP54</p> 	<b>P7</b> 8.5W	<b>V9</b> 2700K / CRI 90 / 539 lm	<b>M2</b> 28°	<b>O1</b> Emergency ON-OFF 1H 220-240V	<b>EP</b>
		<b>W9</b> 3000K / CRI 90 / 624 lm		<b>O3</b> Emergency ON-OFF 3H 220-240V	
		<b>X9</b> 4000K / CRI 90 / 624 lm		<b>D1</b> Emergency DALI-2 1H 220-240V	
	<b>13</b> 14.3W	<b>V9</b> 2700K / CRI 90 / 1125 lm	<b>M2</b> 34°	<b>O1</b> Emergency ON-OFF 1H 220-240V	
		<b>W9</b> 3000K / CRI 90 / 1211 lm		<b>O3</b> Emergency ON-OFF 3H 220-240V	
		<b>X9</b> 4000K / CRI 90 / 1296 lm		<b>D1</b> Emergency DALI-2 1H 220-240V	
<b>D3</b> Emergency DALI-2 3H 220-240V					

# Play

## Deco Emergency

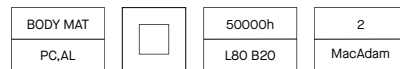

**FAMILIA/FAMÍLIA:** Play Deco Track P.XXX / Play Flat P.XXX / Play Deco Pendant P.XXX / Play Deco Surface P.XXX

# Play Deco Symmetrical

## Trim Emergency

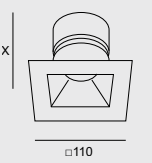

Ejemplo de código / Exemplo de código: **AG23-P7V9M201WR**

Model	W	K / CRI / Real lm	Optics	Source	Finishes	
 <p><b>AG23 -</b> Redondo / Fijo Redondo / fixo 0-25 mm 80 IP54</p> 	<b>P7</b> 8.5W	<b>V9</b> 2700K / CRI 90 / 571 lm	<b>M2</b> 28°	<b>O1</b> Emergency ON-OFF 1H 220-240V	<b>WR</b>	
		<b>W9</b> 3000K / CRI 90 / 624 lm		<b>O3</b> Emergency ON-OFF 3H 220-240V		<b>WG</b>
		<b>X9</b> 4000K / CRI 90 / 637 lm		<b>D1</b> Emergency DALI-2 1H 220-240V		<b>WH</b>
 <p><b>AG27 -</b> Cuadrado / Fijo Cuadrado / fixo 0-25 mm 100 IP54</p> 	<b>13</b> 14.3W	<b>V9</b> 2700K / CRI 90 / 907 lm	<b>M2</b> 34°	<b>O1</b> Emergency ON-OFF 1H 220-240V	<b>WI</b>	
		<b>W9</b> 3000K / CRI 90 / 1271 lm		<b>O3</b> Emergency ON-OFF 3H 220-240V	<b>WJ</b>	
		<b>X9</b> 4000K / CRI 90 / 1424 lm		<b>D1</b> Emergency DALI-2 1H 220-240V	<b>WK</b>	
		<b>D3</b> Emergency DALI-2 3H 220-240V		<b>D3</b> Emergency DALI-2 3H 220-240V	<b>WL</b>	
					<b>WM</b>	
		<b>WN</b>				

# Play Deco Symmetrical Trimless Emergency



Ejemplo de código / Exemplo de código: **AG24-P7V9M2O1WP**

Model	W	K / CRI / Real lm	Optics	Source	Finishes
 <p><b>AG24 -</b> Redondo / Fijo / Sin marco Redondo / fixo / trimless 0-15 mm IP54</p> 	P7 8.5W	V9 2700K / CRI 90 / 571 lm	M2 28°	O1  Emergency ON-OFF 1H 220-240V	<b>WP</b> <b>WS</b> <b>WQ</b>
		W9 3000K / CRI 90 / 624 lm		O3  Emergency ON-OFF 3H 220-240V	
		X9 4000K / CRI 90 / 637 lm		D1  Emergency DALI-2 1H 220-240V	
 <p><b>AG28 -</b> Cuadrado / Fijo / Sin marco Cuadrado / fixo / trimless 0-25 mm IP54</p> 	13 14.3W	V9 2700K / CRI 90 / 1181 lm	M2 34°	O1  Emergency ON-OFF 1H 220-240V	
		W9 3000K / CRI 90 / 1271 lm		O3  Emergency ON-OFF 3H 220-240V	
		X9 4000K / CRI 90 / 1360 lm		D1  Emergency DALI-2 1H 220-240V	
				D3  Emergency DALI-2 3H 220-240V	

# Play Deco Asymmetrical Trim Emergency











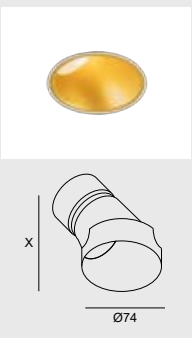

Ejemplo de código / Exemplo de código: **AG25-P7V9M2O1WR**

Model	W	K / CRI / Real lm	Optics	Source	Finishes
 <p><b>AG25 -</b> Redondo / Fijo Redondo / fixo 0-25 mm IP54</p> 	P7 8.5W	V9 2700K / CRI 90 / 528 lm	M2 27°	O1  Emergency ON-OFF 1H 220-240V	<b>WR</b> <b>WG</b> <b>WH</b> <b>WI</b> <b>WJ</b> <b>WK</b> <b>WL</b> <b>WM</b> <b>WN</b>
		W9 3000K / CRI 90 / 527 lm		O3  Emergency ON-OFF 3H 220-240V	
		X9 4000K / CRI 90 / 558 lm		D1  Emergency DALI-2 1H 220-240V	
 <p><b>AG29 -</b> Cuadrado / Fijo Cuadrado / fixo 0-25 mm IP54</p> 	13 14.3W	V9 2700K / CRI 90 / 801 lm	M2 34°	O1  Emergency ON-OFF 1H 220-240V	
		W9 3000K / CRI 90 / 1271 lm		O3  Emergency ON-OFF 3H 220-240V	
		X9 4000K / CRI 90 / 1424 lm		D1  Emergency DALI-2 1H 220-240V	
				D3  Emergency DALI-2 3H 220-240V	

# Play Deco Asymmetrical Trimless Emergency

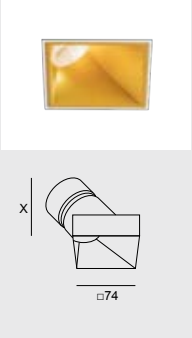

Ejemplo de código / Exemplo de código: **AG26-P7V9M201WP**

Model	W	K / CRI / Real lm	Optics	Source	Finishes
 <p><b>AG26 -</b> Redondo / Fijo /  Sin marco Redondo / fixo /  trimless 0-15 mm 75 IP54</p>	<b>P7</b> 8.5W	<b>V9</b> 2700K / CRI 90 / 528 lm	<b>M2</b> 27°	<b>O1</b>  Emergency ON-OFF 1H 220-240V	<b>WP</b>  <b>WS</b>  <b>WQ</b> 
		<b>W9</b> 3000K / CRI 90 / 527 lm		<b>O3</b>  Emergency ON-OFF 3H 220-240V	
		<b>X9</b> 4000K / CRI 90 / 558 lm		<b>D1</b>  Emergency DALI-2 1H 220-240V	
 <p><b>AG31 -</b> Cuadrado / Fijo /  Sin marco Cuadrado / fixo /  trimless 0-25 mm 75x75 IP54</p>	<b>13</b> 14.3W	<b>V9</b> 2700K / CRI 90 / 1086 lm	<b>M2</b> 34°	<b>O1</b>  Emergency ON-OFF 1H 220-240V	
		<b>W9</b> 3000K / CRI 90 / 1169 lm		<b>O3</b>  Emergency ON-OFF 3H 220-240V	
		<b>X9</b> 4000K / CRI 90 / 1251 lm		<b>D1</b>  Emergency DALI-2 1H 220-240V	
				<b>D3</b>  Emergency DALI-2 3H 220-240V	



Play Deco  
Asymmetrical  
Trim 7W  
Emergency



Play Deco  
Asymmetrical  
Trim 13W  
Emergency



Play Deco  
Asymmetrical  
Trimless 7W  
Emergency



Play Deco  
Asymmetrical  
Trimless 13W  
Emergency



## Accesorios ópticos

### Accessórios óticos



Difuminador de halo (5u.)  
Difusor opalino (5u.)

71-6099-00-00 71-6099-00-00 71-6099-00-00 71-6099-00-00



Confort visual (1u.)  
Conforto visual (1u.)

14 ○

71-4754-14-00 71-4754-14-00 71-4754-14-00 71-4754-14-00

60 ●

71-4754-60-00 71-4754-60-00 71-4754-60-00 71-4754-60-00



Apantallador (5u.)  
Obturador assimetrico (5u.)

60 ●

71-7895-60-00 71-7895-60-00 71-7895-60-00 71-7895-60-00

Play Deco  
Symmetrical  
Trim 7W  
Emergency



Play Deco  
Symmetrical  
Trim 13W  
Emergency



Play Deco  
Symmetrical  
Trimless 7W  
Emergency



Play Deco  
Symmetrical  
Trimless 13W  
Emergency



## Accesorios ópticos

### Accessórios óticos



Difuminador de halo (5u.)  
Difusor opalino (5u.)

71-6099-00-00 71-6099-00-00 71-6099-00-00 71-6099-00-00



Confort visual (1u.)  
Conforto visual (1u.)

14 ○

71-4754-14-00 71-4754-14-00 71-4754-14-00 71-4754-14-00

60 ●

71-4754-60-00 71-4754-60-00 71-4754-60-00 71-4754-60-00



Apantallador (5u.)  
Obturador assimetrico (5u.)

60 ●

71-7895-60-00 71-7895-60-00 71-7895-60-00 71-7895-60-00

# Infinite Pro

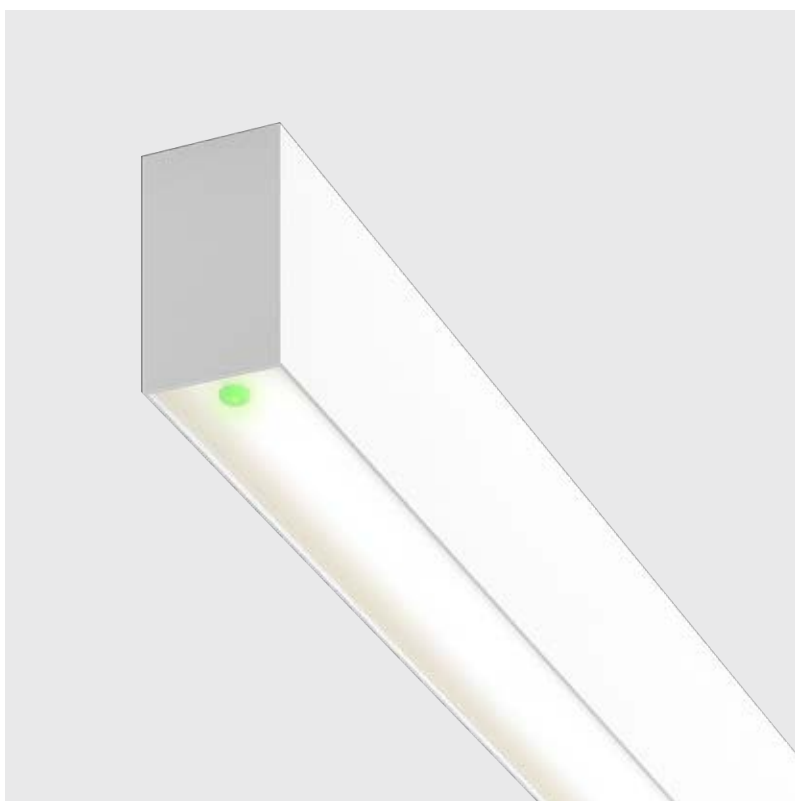

Infinite Pro es la solución perfecta para iluminar espacios que requieren un alto confort, ofreciendo una iluminación concebida para mejorar el bienestar de las personas y las empresas, sobre todo en oficinas o en espacios de trabajo donde la calidad de la luz es fundamental. Infinite Pro emergencia incluye el LED de señalización en la luminaria por lo que la instalación es mucho más fácil y no requiere de elementos adicionales.

Infinite Pro é a solução perfeita para a iluminação de espaços que requerem um elevado nível de conforto, oferecendo uma iluminação concebida para melhorar o bem-estar de pessoas e empresas, sobretudo em escritórios ou zonas de trabalho onde a qualidade da luz é fundamental. Infinite Pro emergência inclui o LED de sinalização na luminária pelo que a instalação é muito mais fácil e não necessita de elementos adicionais.



## Monitorización DALI

## Monitorização DALI

Conocimiento a tiempo real del estatus de las luminarias.  
Conhecimento em tempo real do estado das luminárias.

# Infinite Pro

## Emergency

BODY MAT	DIF MAT		50000h	3
AL	PC		L80 B20	MacAdam

FAMILIA/FAMÍLIA: Infinite Pro Opticell P.XXX

# Infinite Pro Hexa-Cell





## Emergency

IP	UGR		
40	<10		

Ejemplo de código / Exemplo de código: **AK14-34W8HC0314**

Model	W	K / CRI / Real lm	Optics	Source	Finishes					
<b>1136 mm</b>  <b>AK14 -</b> Superficie Superficie IP40 14 60 N3	<b>34</b> 33.7W	<b>W8</b> 3000K / CRI 80 / 1290 lm	<b>HC</b> Hexa-Cell	<b>O3</b>	<b>14</b> <b>60</b> <b>N3</b> <b>GA</b> <b>GB</b>					
		<b>W9</b> 3000K / CRI 90 / 1152 lm								
		<b>X8</b> 4000K / CRI 80 / 4079 lm								
		<b>X9</b> 4000K / CRI 90 / 3143 lm								
<b>1700 mm</b>  <b>AK15 -</b> Suspendida Suspensa IP40 14 60 N3	<b>52</b> 50.6W	<b>W8</b> 3000K / CRI 80 / 1965 lm	<b>HC</b> Hexa-Cell	<b>O3</b>	<b>14</b> <b>60</b> <b>N3</b> <b>GA</b> <b>GB</b>					
		<b>W9</b> 3000K / CRI 90 / 1755 lm								
		<b>X8</b> 4000K / CRI 80 / 6264 lm								
		<b>X9</b> 4000K / CRI 90 / 4827 lm								
 <b>AK16 -</b> Empotrada Encastrada 0-25 mm  1140x65 IP44 14				<b>D3</b>	<b>14</b> <b>60</b> <b>N3</b> <b>GA</b> <b>GB</b>					
						 <b>AK23 -</b> Suspendida / Acústica Suspensa / Acústica IP40 GA GB				<b>14</b> <b>60</b> <b>N3</b> <b>GA</b> <b>GB</b>
 <b>AK19 -</b> Empotrada Encastrada 0-25 mm  1705x65 IP40 14										
						 <b>AK21 -</b> Suspendida Suspensa IP40 14 60 N3				



Infinite Pro Hexa-Cell 1136mm Surface	Infinite Pro Hexa-Cell 1700mm Surface	Infinite Pro Hexa-Cell 1700mm Recessed	Infinite Pro Hexa-Cell 1136mm Suspended Acoustic	Infinite Pro Hexa-Cell 1700mm Suspended
				

**Fuentes de alimentación**  
Fontes de alimentação



P. DER

	Florón suspendido con toma de corriente Emergency Florão suspenso com tomada de corrente Emergency	14 ○	<b>71-A223-14-00</b>	<b>71-A223-14-00</b>	-	-	-
	Fuente de alimentación DALI Emergency Fonte de alimentação DALI Emergency	14 ○	-	-	<b>71-A228-14-00</b>	-	-
	Fuente de alimentación DALI Emergency Fonte de alimentação DALI Emergency	60 ●	<b>71-A228-60-00</b>	-	-	-	<b>71-A228-60-00</b>
	Fuente de alimentación DALI Emergency Fonte de alimentação DALI Emergency	N3 ○	-	-	-	-	-





**Accesorios ópticos**  
Acessórios óticos

	Difusor microprismático Difusor microprismático		-	-	<b>71-A940-00-00</b>	<b>71-A939-00-00</b>	<b>71-A940-00-00</b>
------------------------------------------------------------------------------------	----------------------------------------------------	--	---	---	----------------------	----------------------	----------------------

**Accesorios de unión**  
Acessórios de união

	Kit unión "I" DALI Kit união "I" DALI		<b>71-A955-00-DA</b>	<b>71-A955-00-DA</b>	<b>71-A955-00-DA</b>	<b>71-A955-00-DA</b>	<b>71-A955-00-DA</b>
			<b>71-A955-00-00</b>	<b>71-A955-00-00</b>	<b>71-A955-00-00</b>	<b>71-A955-00-00</b>	<b>71-A955-00-00</b>



Infinite Pro Hexa-Cell 1136mm Suspended	Infinite Pro Hexa-Cell 1136mm Recessed	Infinite Pro Opal 1136mm Suspended Acoustic	Infinite Pro Opal 1700mm Surface	Infinite Pro Opal 1136mm Recessed
				

### Fuentes de alimentación Fontes de alimentação



P. DER

	Florón suspendido con toma de corriente Emergency Florão suspenso com tomada de corrente Emergency	14 ○	-	-	-	<b>71-A223-14-00</b>	-
	Fuente de alimentación DALI Emergency Fonte de alimentação DALI Emergency	14 ○	-	<b>71-A228-14-00</b>	-	-	<b>71-A228-14-00</b>
	Fuente de alimentación DALI Emergency Fonte de alimentação DALI Emergency	60 ●	-	-	-	-	-
	Fuente de alimentación DALI Emergency Fonte de alimentação DALI Emergency	N3 ○	-	-	-	-	-

### Accesorios ópticos Acessórios óticos

	Difusor microprismático Difusor microprismático		<b>71-A939-00-00</b>	<b>71-A939-00-00</b>	<b>71-A939-00-00</b>	-	<b>71-A939-00-00</b>
------------------------------------------------------------------------------------	----------------------------------------------------	--	----------------------	----------------------	----------------------	---	----------------------

### Accesorios de unión Acessórios de união

	Kit unión "I" DALI Kit união "I" DALI		<b>71-A955-00-DA</b>	<b>71-A955-00-DA</b>	<b>71-A955-00-DA</b>	<b>71-A955-00-DA</b>	<b>71-A955-00-DA</b>
			<b>71-A955-00-00</b>	<b>71-A955-00-00</b>	<b>71-A955-00-00</b>	<b>71-A955-00-00</b>	<b>71-A955-00-00</b>

Infinite Pro  
Opal 1136mm  
SurfaceInfinite Pro  
Opal 1136mm  
SuspendedInfinite Pro  
Opal 1700mm  
RecessedInfinite Pro  
Opal 1700mm  
Suspended**Fuentes de alimentación**  
Fontes de alimentação

P. DER

	Florón suspendido con toma de corriente Emergency Florão suspenso com tomada de corrente Emergency	14 ○	<b>71-A223-14-00</b>	-	-	-
	Fuente de alimentación DALI Emergency Fonte de alimentação DALI Emergency	14 ○	-	-	<b>71-A228-14-00</b>	-
	Fuente de alimentación DALI Emergency Fonte de alimentação DALI Emergency	60 ●	<b>71-A228-60-00</b>	-	-	<b>71-A228-60-00</b>
	Fuente de alimentación DALI Emergency Fonte de alimentação DALI Emergency	N3 ○	-	<b>71-A228-N3-00</b>	-	<b>71-A228-N3-00</b>

**Accesorios ópticos**  
Acessórios óticos

	Difusor microprismático Difusor microprismático		-	<b>71-A939-00-00</b>	<b>71-A940-00-00</b>	<b>71-A940-00-00</b>
-----------------------------------------------------------------------------------	----------------------------------------------------	--	---	----------------------	----------------------	----------------------

**Accesorios de unión**  
Acessórios de união

	Kit unión "I" DALI Kit união "I" DALI		<b>71-A955-00-DA</b>	<b>71-A955-00-DA</b>	<b>71-A955-00-DA</b>	<b>71-A955-00-DA</b>
<b>Falta tipo</b>	<b>Falta tipo accesorio</b>	<b>Falta tipo</b>	<b>71-A955-00-00</b>	<b>71-A955-00-00</b>	<b>71-A955-00-00</b>	<b>71-A955-00-00</b>

			<b>71-A955-00-00</b>	<b>71-A955-00-00</b>	<b>71-A955-00-00</b>	<b>71-A955-00-00</b>
-------------------------------------------------------------------------------------	--	--	----------------------	----------------------	----------------------	----------------------

# Infinite Pro

## Infinite Pro Opal Emergency











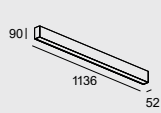



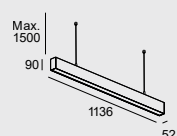
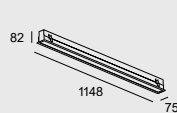
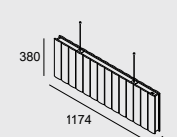
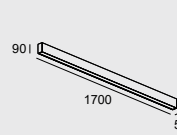
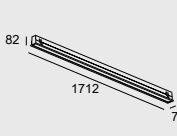
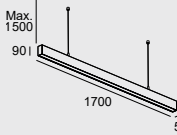

IP
40

UGR
<10



EMERGENCY LIGHTING

Ejemplo de código / Exemplo de código: **AK14-34W8PM0314**

Model	W	K / CRI / Real lm	Optics	Source	Finishes	
<b>1136 mm</b>  <b>AK14 -</b> Superficie Superficie IP40 14 60 N3	<b>34</b> 33.7W	<b>W8</b> 3000K / CRI 80 / 1290 lm	<b>PM</b> Opal	<b>O3</b>	<b>14</b>  <b>60</b>  <b>N3</b>  <b>GA</b>  <b>GB</b> 	
		<b>W9</b> 3000K / CRI 90 / 1152 lm				
		<b>X8</b> 4000K / CRI 80 / 4079 lm				
		<b>X9</b> 4000K / CRI 90 / 3143 lm				
<b>1700 mm</b>  <b>AK15 -</b> Suspendeda Suspensa IP40 14 60 N3  <b>AK16 -</b> Empotrada Encastrada 0-25 mm 1140x65 IP44 14  <b>AK23 -</b> Suspendeda / Acústica Suspensa / Acústica IP40 GA GB  <b>AK18 -</b> Superficie Superficie IP40 14 60 N3  <b>AK19 -</b> Empotrada Encastrada 0-25 mm 1705x65 IP40 14  <b>AK21 -</b> Suspendeda Suspensa IP40 14 60 N3	<b>52</b> 50.6W	<b>W8</b> 3000K / CRI 80 / 1965 lm	<b>PM</b> Opal	<b>O3</b>	<b>14</b>  <b>60</b>  <b>N3</b>  <b>GA</b>  <b>GB</b> 	
		<b>W9</b> 3000K / CRI 90 / 1755 lm				
			<b>X8</b> 4000K / CRI 80 / 6264 lm		<b>D3</b>	<b>14</b>  <b>60</b>  <b>N3</b>  <b>GA</b>  <b>GB</b> 
			<b>X9</b> 4000K / CRI 90 / 4827 lm			

# Bento

Colección de downlights lineales, fruto de un largo estudio por parte de los desarrolladores de producto de LedsC4 con el fin de obtener una luminaria de alto confort visual y óptimo rendimiento. Su versión de emergencia permite que el proyecto sea más homogéneo y que con el mismo modelo de luminaria se pueda genera también una iluminación antipánico.

Coleção de downlights lineares, fruto de um longo estudo por parte dos criadores de produto da LedsC4 com o objetivo de obter uma luminária com elevado conforto visual e ótimo rendimento. A sua versão de emergência permite que o projeto seja mais homogéneo e que com o mesmo modelo de luminária também se possa gerar uma iluminação antipânico.

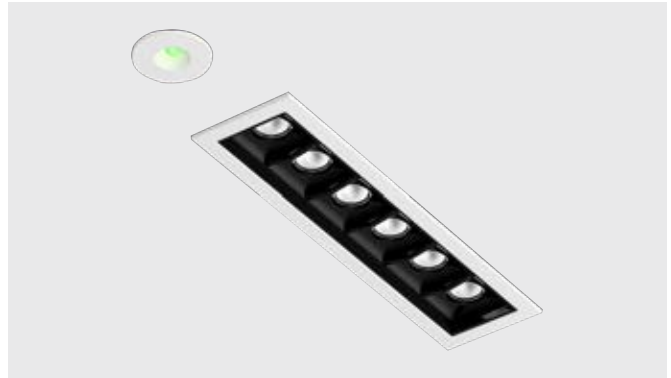

## Bento Emergency

BODY MAT		50000h	3
PC,AL		L80 B20	MacAdam

**FAMILIA/FAMÍLIA:** Bento Low Voltage P.XXX / Bento Recessed Standard P.XXX / Bento Recessed IP P.XXX / Bento Wall Washer P.XXX / Bento Surface P.XXX / Bento Surface P.XXX / Bento Surface P.XXX

### Bento Standard 3 LEDS Trim

IP	WELL			
23				

● ●  
14 60

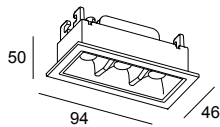

40x89 0-18 mm

LED								
Real Lm	Real Lm. Em	Optics	H. emergency	Perma-nent	Auto test	Code		
560	106	18°	3	Yes	No	<b>90-6364-14-OE</b>	Emergency ON-OFF	
560	106	18°	3	Yes	No	<b>90-6364-14-DE</b>	Emergency DALi	
560	106	18°	3	Yes	No	<b>90-6364-60-OE</b>	Emergency ON-OFF	
560	106	18°	3	Yes	No	<b>90-6364-60-DE</b>	Emergency DALi	
638	110	38°	3	Yes	No	<b>90-6366-14-OE</b>	Emergency ON-OFF	
638	110	38°	3	Yes	No	<b>90-6366-14-DE</b>	Emergency DALi	
638	110	38°	3	Yes	No	<b>90-6366-60-OE</b>	Emergency ON-OFF	
638	110	38°	3	Yes	No	<b>90-6366-60-DE</b>	Emergency DALi	
603	100	47°	3	Yes	No	<b>90-6368-14-OE</b>	Emergency ON-OFF	
603	100	47°	3	Yes	No	<b>90-6368-14-DE</b>	Emergency DALi	
603	100	47°	3	Yes	No	<b>90-6368-60-OE</b>	Emergency ON-OFF	
603	100	47°	3	Yes	No	<b>90-6368-60-DE</b>	Emergency DALi	

## Bento Standard 3 LEDS Trim

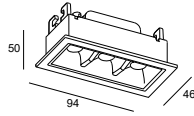

40x89 0-18 mm

LED								
Real Lm	Real Lm. Em	Optics	H. emergency	Perma- nent	Auto test	Code		
560	106	18°	3	Yes	No	<b>90-6365-14-OE</b>	Emergency ON-OFF	
560	106	18°	3	Yes	No	<b>90-6365-14-DE</b>	Emergency DALi	
560	106	18°	3	Yes	No	<b>90-6365-60-OE</b>	Emergency ON-OFF	
560	106	18°	3	Yes	No	<b>90-6365-60-DE</b>	Emergency DALi	
638	110	38°	3	Yes	No	<b>90-6367-14-OE</b>	Emergency ON-OFF	
638	110	38°	3	Yes	No	<b>90-6367-14-DE</b>	Emergency DALi	
638	110	38°	3	Yes	No	<b>90-6367-60-OE</b>	Emergency ON-OFF	
638	110	38°	3	Yes	No	<b>90-6367-60-DE</b>	Emergency DALi	
603	100	47°	3	Yes	No	<b>90-6369-14-OE</b>	Emergency ON-OFF	
603	100	47°	3	Yes	No	<b>90-6369-14-DE</b>	Emergency DALi	
603	100	47°	3	Yes	No	<b>90-6369-60-OE</b>	Emergency ON-OFF	
603	100	47°	3	Yes	No	<b>90-6369-60-DE</b>	Emergency DALi	

14 60

## Bento Standard 3 LEDS Trim



14 60

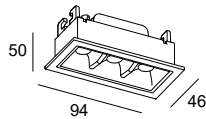

40x168 0-18 mm

LED								
Real Lm	Real Lm. Em	Optics	H. emergency	Perma- nent	Auto test	Code		
609	117	18°	3	Yes	No	<b>90-6673-14-OE</b>	Emergency ON-OFF	
609	117	18°	3	Yes	No	<b>90-6673-14-DE</b>	Emergency DALi	
609	117	18°	3	Yes	No	<b>90-6673-60-OE</b>	Emergency ON-OFF	
609	117	18°	3	Yes	No	<b>90-6673-60-DE</b>	Emergency DALi	
693	122	38°	3	Yes	No	<b>90-6674-14-OE</b>	Emergency ON-OFF	
693	122	38°	3	Yes	No	<b>90-6674-14-DE</b>	Emergency DALi	
693	122	38°	3	Yes	No	<b>90-6674-60-OE</b>	Emergency ON-OFF	
693	122	38°	3	Yes	No	<b>90-6674-60-DE</b>	Emergency DALi	
655	110	47°	3	Yes	No	<b>90-6675-14-OE</b>	Emergency ON-OFF	
655	110	47°	3	Yes	No	<b>90-6675-14-DE</b>	Emergency DALi	
655	110	47°	3	Yes	No	<b>90-6675-60-OE</b>	Emergency ON-OFF	
655	110	47°	3	Yes	No	<b>90-6675-60-DE</b>	Emergency DALi	

Bento Standard 6 LEDs Trim



14 60

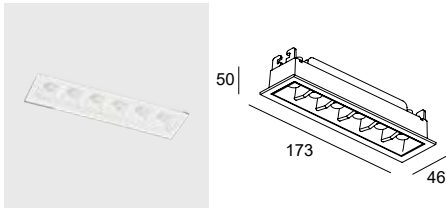

40x168 0-18 mm

LED								
Real Lm	Real Lm.	Em	Optics	H. emergency	Perma- nent	Auto test	Code	
1119	117	18°	3	Yes	No	No	<b>90-6370-14-OE</b>	Emergency ON-OFF
1119	117	18°	3	Yes	No	No	<b>90-6370-14-DE</b>	Emergency DALi
1119	117	18°	3	Yes	No	No	<b>90-6370-60-OE</b>	Emergency ON-OFF
1119	117	18°	3	Yes	No	No	<b>90-6370-60-DE</b>	Emergency DALi
1276	110	38°	3	Yes	No	No	<b>90-6372-14-OE</b>	Emergency ON-OFF
1276	110	38°	3	Yes	No	No	<b>90-6372-14-DE</b>	Emergency DALi
1276	110	38°	3	Yes	No	No	<b>90-6372-60-OE</b>	Emergency ON-OFF
1276	110	38°	3	Yes	No	No	<b>90-6372-60-DE</b>	Emergency DALi
1205	104	47°	3	Yes	No	No	<b>90-6374-14-OE</b>	Emergency ON-OFF
1205	104	47°	3	Yes	No	No	<b>90-6374-14-DE</b>	Emergency DALi
1205	104	47°	3	Yes	No	No	<b>90-6374-60-OE</b>	Emergency ON-OFF
1205	104	47°	3	Yes	No	No	<b>90-6374-60-DE</b>	Emergency DALi

Bento Standard 6 LEDs Trim



14 60

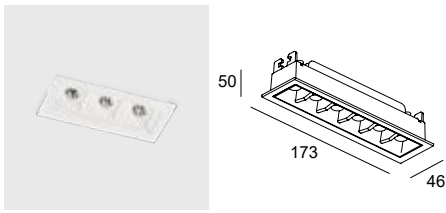

40x168 0-18 mm

LED								
Real Lm	Real Lm.	Em	Optics	H. emergency	Perma- nent	Auto test	Code	
1119	117	18°	3	Yes	No	No	<b>90-6371-14-OE</b>	Emergency ON-OFF
1119	117	18°	3	Yes	No	No	<b>90-6371-14-DE</b>	Emergency DALi
1119	117	18°	3	Yes	No	No	<b>90-6371-60-OE</b>	Emergency ON-OFF
1119	117	18°	3	Yes	No	No	<b>90-6371-60-DE</b>	Emergency DALi
1276	110	38°	3	Yes	No	No	<b>90-6373-14-OE</b>	Emergency ON-OFF
1276	110	38°	3	Yes	No	No	<b>90-6373-14-DE</b>	Emergency DALi
1276	110	38°	3	Yes	No	No	<b>90-6373-60-OE</b>	Emergency ON-OFF
1276	110	38°	3	Yes	No	No	<b>90-6373-60-DE</b>	Emergency DALi
1205	104	47°	3	Yes	No	No	<b>90-6375-14-OE</b>	Emergency ON-OFF
1205	104	47°	3	Yes	No	No	<b>90-6375-14-DE</b>	Emergency DALi
1205	104	47°	3	Yes	No	No	<b>90-6375-60-OE</b>	Emergency ON-OFF
1205	104	47°	3	Yes	No	No	<b>90-6375-60-DE</b>	Emergency DALi



**Bento Standard 6 LEDs Trim**

IP
23

WELL



○ ●  
14 60

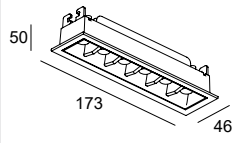

40x168 0-18 mm

LED							
Real Lm	Real Lm. Em	Optics	H. emer-gency	Perma-nent	Auto test	Code	
1216	129	18°	3	Yes	No	<b>90-6679-14-OE</b>	Emergency ON-OFF
1216	129	18°	3	Yes	No	<b>90-6679-14-DE</b>	Emergency DALi
1216	129	18°	3	Yes	No	<b>90-6679-60-OE</b>	Emergency ON-OFF
1216	129	18°	3	Yes	No	<b>90-6679-60-DE</b>	Emergency DALi
1387	121	38°	3	Yes	No	<b>90-6680-14-OE</b>	Emergency ON-OFF
1387	121	38°	3	Yes	No	<b>90-6680-14-DE</b>	Emergency DALi
1387	121	38°	3	Yes	No	<b>90-6680-60-OE</b>	Emergency ON-OFF
1387	121	38°	3	Yes	No	<b>90-6680-60-DE</b>	Emergency DALi
1310	115	47°	3	Yes	No	<b>90-6681-14-OE</b>	Emergency ON-OFF
1310	115	47°	3	Yes	No	<b>90-6681-14-DE</b>	Emergency DALi
1310	115	47°	3	Yes	No	<b>90-6681-60-OE</b>	Emergency ON-OFF
1310	115	47°	3	Yes	No	<b>90-6681-60-DE</b>	Emergency DALi



EMERGENCY LIGHTING

# Afrodita

BODY MAT	DIF MAT		50000h	3
AL	GLA		L80 B20	MacAdam

**FAMILIA/FAMÍLIA:** Afrodita Infinite P.XXX / Afrodita Tech P.XXX / Afrodita LED P.XXX / Afrodita GU10 Ceiling P.XXX

Aplique líneas modernas y sencillas pensado para iluminar espacios exteriores. Puede utilizarse para enfatizar recorridos o entradas desde la pared.

Aplique de linhas modernas e simples pensado para iluminar espaços exteriores. Pode ser utilizado para enfatizar percursos ou entradas desde a parede.

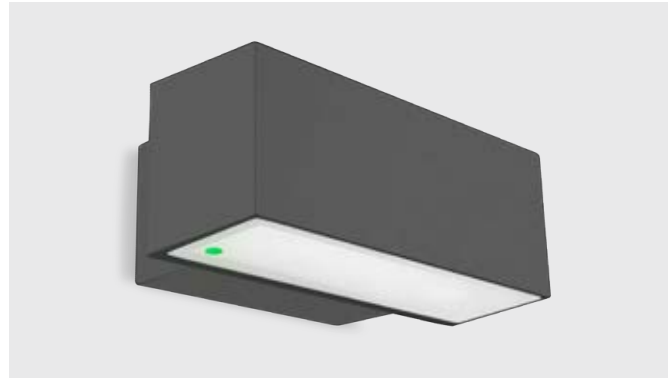

## Afrodita Emergency

IP	IK	BREEAM	SEA SIDE SUITABLE		
66	04				

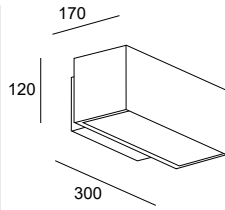
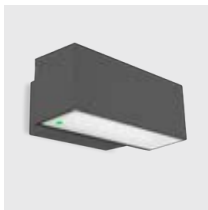

LED   Real Lm 1670							
Real Lm. Em	Optics	H. emergency	Perma- nent	Auto test	Code		
557	88°	1	Yes	No	<b>05-8764-Z5-OE</b>	ON-OFF 220-240V	
557	88°	3	Yes	No	<b>05-8765-Z5-OE</b>	ON-OFF 220-240V	

IP	IK	BREEAM	SEA SIDE SUITABLE		
66	04				

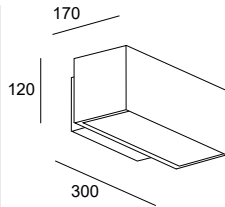
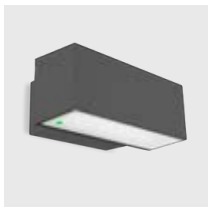

LED   Real Lm 1837							
Real Lm. Em	Optics	H. emergency	Perma- nent	Auto test	Code		
612	88°	1	Yes	No	<b>05-8766-Z5-OE</b>	ON-OFF 220-240V	
612	88°	3	Yes	No	<b>05-8767-Z5-OE</b>	ON-OFF 220-240V	

# Solid

BODY MAT	DIF MAT		50000h	5
PC	PC		L80 B20	MacAdam

Plafón lineal con un alto paquete lumínico. Cuenta con un alto grado de protección contra impactos y entrada de agua o polvo. Puede utilizarse en espacios que requieran de una protección especial como aparcamientos o áreas comunes de zonas residenciales que se encuentren a la intemperie.

Plafon linear com um alto pacote luminoso. Possui um elevado grau de proteção contra impactos e entrada de água ou pó. Pode ser utilizado em espaços que requeiram uma proteção especial como estacionamentos ou áreas comuns de zonas residenciais que se encontrem no exterior.



## Solid 1260mm

IP	IK	UGR	BREEAM		SEA SIDE SUITABLE	LED	DRIVER
66	10	<19					

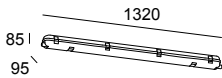

<b>LED   W 27.4   Real Lm 2872</b>				
<b>Real Lm. Em</b>	<b>H. emergency</b>	<b>Perma-nent</b>	<b>Auto test</b>	<b>Code</b>
419	3	Yes	Yes	<b>15-E006-34-OE</b>

34

## Solid 1560mm

IP	IK	UGR	LOW FLICKER	BREEAM		SEA SIDE SUITABLE	LED	DRIVER
66	10	<22						

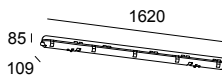

<b>LED   W 60   Real Lm 6082</b>				
<b>Real Lm. Em</b>	<b>H. emergency</b>	<b>Perma-nent</b>	<b>Auto test</b>	<b>Code</b>
434	3	Yes	Yes	<b>15-E007-34-OE</b>

34

# Sia

## Standard Emergency

BODY MAT	DIF MAT		50000h	2
AL	PC		L80 B20	MacAdam

**FAMILIA/FAMÍLIA:** Sia Standard P.XXX

Sia proyecta una luz que se adapta a las geometrías, a los volúmenes y a las distancias, una luz sin obstáculos. Gracias a la combinación de una lente de policarbonato que aporta uniformidad y un reflector cromado por alto vacío que proporciona un punto de luz uniforme, esta luminaria ofrece un máximo confort visual con un elevado rendimiento. La versión de emergencia permite conseguir instalaciones homogéneas al no tener que utilizar diferentes luminarias para incorporar el alumbrado antipánico.











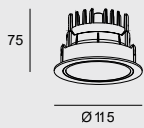

Sia projeta uma luz que se adapta às geometrias, aos volumes e às distâncias, uma luz sem obstáculos. Graças à combinação de uma lente de policarbonato, que fornece uniformidade, e um refletor cromado de alto vácuo, que proporciona um ponto de luz uniforme, esta luminária oferece o máximo conforto visual com um elevado rendimento. A versão de emergência permite conseguir instalações homogéneas, ao não ter de utilizar luminárias diferentes para incorporar iluminação antipânico.

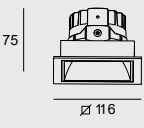

## Sia Standard 115 Emergency

IP	IK			
54	03			

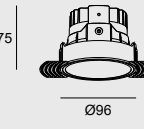
Ejemplo de código / Exemplo de código: **AH11-12V8W10314**

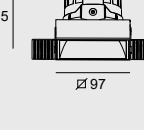
Model	W	K / CRI / Real lm	Optics	Source	Finishes
<b>AH11 -</b> Redondo / Pequeño / Con Marco Redondo / Pequeno / Com Aro ≡ 0-16 mm ≡ 100 IP54  	<input type="radio"/> 14 <input checked="" type="radio"/> 60 12 13.2W	<b>V8</b> 2700K / CRI80 / 1407 lm	<b>W1</b> 77°	<b>O3</b>  Emergency ON-OFF 3H/ 220-240V	<b>14</b>  <b>60</b>  <b>WT</b> 
		<b>W8</b> 3000K / CRI80 / 1407 lm		<b>D3</b>  Emergency DALI 3H 220-240V	
		<b>W9</b> 3000K / CRI90 / 1261 lm			
		<b>X8</b> 4000K / CRI80 / 1401 lm			
<b>AH13 -</b> Cuadrado / Pequeño / Con Marco Quadrado / Pequeno / Com Aro ≡ 0-16 mm ≡ 100x100 IP54  	<input type="radio"/> 14 <input checked="" type="radio"/> 60 17 19.8W	<b>V8</b> 2700K / CRI80 / 1829 lm	<b>W1</b> 77°	<b>O3</b>  Emergency ON-OFF 3H/ 220-240V	
		<b>W8</b> 3000K / CRI80 / 1822 lm		<b>D3</b>  Emergency DALI 3H 220-240V	
		<b>W9</b> 3000K / CRI90 / 1640 lm			
		<b>X8</b> 3000K / CRI80 / 1822 lm			
<b>AH12 -</b> Redondo / Pequeño / Sin Marco Redondo / Pequeno / Sem Aro ≡ 0-16 mm ≡ 96 IP54  	<input type="radio"/> 14 <input checked="" type="radio"/> 60 WT				
<b>AH14 -</b> Cuadrado / Pequeño / Sin Marco Quadrado / Pequeno / Sem Aro ≡ 0-16 mm ≡ 97x97 IP54  	<input type="radio"/> 14 <input checked="" type="radio"/> 60 WT				

Ejemplo de código / Exemplo de código: **AH15-25V8W10314**

Model	W	K / CRI / Real lm	Optics	Source	Finishes	
<b>AH15 -</b> Redondo / Grande / Con Marco Redondo / Grande / Com Aro 0-16 mm 150 IP54		<b>25</b> 28.5W	<b>W1</b> 79°	<b>O3</b> <b>D3</b>	<b>14</b> <b>60</b> <b>WT</b>	
		<b>V8</b> 2700K / CRI80 / 2840 lm				
		<b>W8</b> 3000K / CRI80 / 2840 lm				
		<b>W9</b> 3000K / CRI90 / 2572 lm				
<b>AH17 -</b> Cuadrado / Grande / Con Marco Cuadrado / Grande / Com Aro 0-16 mm 150x150 IP54		<b>33</b> 36.8W	<b>W1</b> 79°	<b>O3</b>		
		<b>V8</b> 2700K / CRI80 / 3459 lm				
		<b>W8</b> 3000K / CRI80 / 3459 lm				
<b>AH16 -</b> Redondo / Grande / Sin Marco Redondo / Grande / Sem Aro 0-16 mm 141 IP54						
						<b>W9</b> 3000K / CRI90 / 3133 lm
						<b>X8</b> 4000K / CRI80 / 3481 lm
<b>AH18 -</b> Cuadrado / Grande / Sin Marco Cuadrado / Grande / Sem Aro 0-16 mm 150x150 IP54						

# Sia Standard 225 Emergency

IP
54

IK
03

UGR
<22





Ejemplo de código / Exemplo de código: **AH19-37W8W10314**

Model	W	K / CRI / Real lm	Optics	Source	Finishes
<b>AH19 -</b> Redondo / Super Grande / Con Marco Redondo / Super Grande / Com Aro 0-16 mm 225 IP54  	<b>37</b> 40.7W	<b>W8</b> 3000K / CRI80 / 3548 lm	<b>W1</b> 76°	<b>O3</b> Emergency ON-OFF 3H/ 220-240V	<b>14</b>
		<b>W9</b> 3000K / CRI90 / 3080 lm		<b>D3</b> Emergency DALI 3H 220-240V	<b>60</b>
		<b>X8</b> 4000K / CRI80 / 3548 lm		<b>WT</b>	
	<b>44</b> 49W	<b>W8</b> 3000K / CRI80 / 4102 lm	<b>W1</b> 76°	<b>O3</b> Emergency ON-OFF 3H 220-240V	
	<b>W9</b> 3000K / CRI90 / 3560 lm	<b>D3</b> Emergency DALI 3H 220-240V			
	<b>X8</b> 4000K / CRI80 / 4102 lm				
<b>AH21 -</b> Redondo / Super Grande / Sin Marco Redondo / Super Grande / Sem Aro 0-16 mm 190 IP54  					WT

BODY MAT	DIF MAT		50000h	3
AL	PMMA		L80 B20	MacAdam

FAMILIA/FAMÍLIA: Vol Standard P.XXX

Vol Ø135 mm

IP	IK			
54	08			

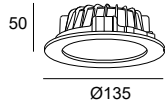

117  0-25 mm

LED   Real Lm 847					
Real Lm.H. Em	emer-gency	Perma-nent	Auto test Code		
299	3	Yes	No	<b>90-4880-14-OE</b>	Emergency ON-OFF 220-240V

14

Vol Ø135 mm

IP	IK			
54	08			

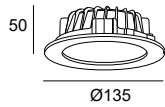

117  0-25 mm

LED   Real Lm 888					
Real Lm.H. Em	emer-gency	Perma-nent	Auto test Code		
299	3	Yes	No	<b>90-4881-14-OE</b>	Emergency ON-OFF 220-240V

14

Vol Ø205 mm

IP	IK			
54	08			

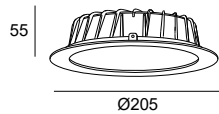

180  0-25 mm

LED   Real Lm 1934					
Real Lm.H. Em	emer-gency	Perma-nent	Auto test Code		
350	3	Yes	Yes	<b>90-2899-14-OE</b>	Emergency ON-OFF 220-240V

14



Vol Ø205 mm

IP	IK			
54	08			

○  
14

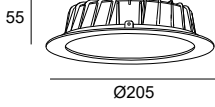

LED   Real Lm 1989					
Real Lm.	H. emer- Em	gency	Perma- nent	Auto test Code	
298	3	Yes	Yes	<b>90-4883-14-OE</b>	Emergency ON-OFF 220-240V

180 0-25 mm

Vol Ø254 mm

IP	IK			
54	08			

○  
14

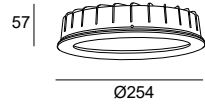

LED   Real Lm 3012					
Real Lm.	H. emer- Em	gency	Perma- nent	Auto test Code	
299	3	Yes	No	<b>90-4885-14-OE</b>	Emergency ON-OFF 220-240V

230 0-25 mm

Vol Ø254 mm

IP	IK			
54	08			

○  
14

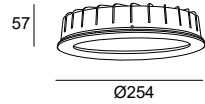

LED   Real Lm 3109					
Real Lm.	H. emer- Em	gency	Perma- nent	Auto test Code	
299	3	Yes	No	<b>90-4886-14-OE</b>	Emergency ON-OFF 220-240V

230 0-25 mm

# Veo Emergency

BODY MAT	DIF MAT		50000h	3
PC,AL	PC		L80 B20	MacAdam



FAMILIA/FAMÍLIA: VEO P.XXX

Colección de downlights para espacios de diversos usos y propósitos, que se adapta a distintos diámetros de empotrar, facilitando así, su instalación en techos donde exista un hueco previo.

Coleção de downlights para espaços de diversos usos e propósitos, que se adapta a diferentes diâmetros de encastrar, facilitando assim a sua instalação em tetos onde exista um furo prévio.



## Veo Emergency 130mm

IP	LOW		
54	FLICKER		

14

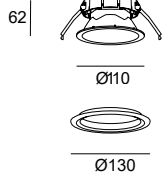



100 0-25 mm

### LED | Real Lm 1123

Real Lm. Em	Optics	Auto test	Code	
370	67	No	<b>90-A032-14-03</b>	Emergency ON-OFF 220-240V
370	67	No	<b>90-A032-14-D3</b>	Emergency DALI-2 220-240V

## Veo Emergency 130mm

IP	LOW		
54	FLICKER		

14

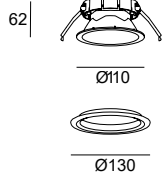



100 0-25 mm

### LED | Real Lm 1156

Real Lm. Em	Optics	Auto test	Code	
380	67	No	<b>90-A033-14-03</b>	Emergency ON-OFF 220-240V
380	67	No	<b>90-A033-14-D3</b>	Emergency DALI-2 220-240V

## Veo Emergency 180mm

IP	UGR	LOW		
54	<22	FLICKER		

14

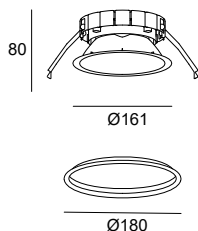

150-170 0-25 mm

### LED | Real Lm 1434

Real Lm. Em	Optics	Auto test	Code	
370	66	No	<b>90-A034-14-03</b>	Emergency ON-OFF 220-240V
370	66	No	<b>90-A034-14-D3</b>	Emergency DALI-2 220-240V

### Veo Emergency 180mm

IP	UGR	LOW		
54	<22	FLICKER		

14

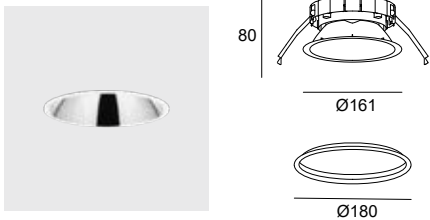

150-170 0-25 mm

LED   Real Lm 1477				
Real Lm. Em	Optics	Auto test	Code	
380	66	No	<b>90-A035-14-03</b>	Emergency ON-OFF 220-240V
380	66	No	<b>90-A035-14-D3</b>	Emergency DALI-2 220-240V

### Veo Emergency 230mm

IP	UGR	LOW		
54	<19	FLICKER		

14

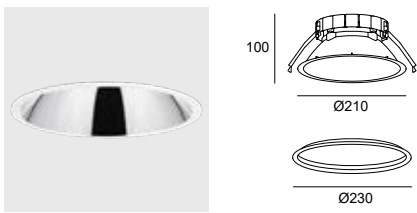

200-220 0-25 mm

LED   Real Lm 1960				
Real Lm. Em	Optics	Auto test	Code	
370	74	No	<b>90-A036-14-03</b>	Emergency ON-OFF 220-240V
370	74	No	<b>90-A036-14-D3</b>	Emergency DALI-2 220-240V

### Veo Emergency 230mm

IP	UGR	LOW		
54	<19	FLICKER		

14

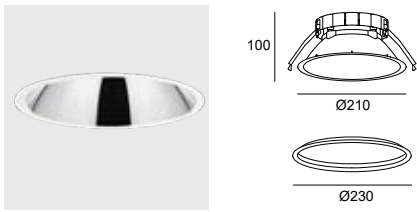

200-220 0-25 mm

LED   Real Lm 2019				
Real Lm. Em	Optics	Auto test	Code	
380	74	No	<b>90-A037-14-03</b>	Emergency ON-OFF 220-240V
380	74	No	<b>90-A037-14-D3</b>	Emergency DALI-2 220-240V

### Accesorios de fijación Acessórios de fixação



Anillo extra para adaptar a diferentes diámetros  
Bisel extra para adaptar a diferentes diámetros

Included

**FAMILIA/FAMÍLIA:** Ecofit Opticell P.XXX







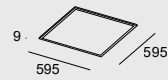

Los espacios de trabajo son cada vez más exigentes y requieren iluminación confortable e integradora, que potencie el bienestar y la salud de las personas. Ecofit es una colección de paneles altamente eficientes con dos posibilidades de ópticas para adaptarse a las distintas necesidades de la zona a iluminar.

Os espaços de trabalho são cada vez mais exigentes e requerem iluminação confortável e integradora que potencie o bem-estar e a saúde das pessoas. Ecofit é uma coleção de painéis altamente eficientes com duas possibilidades de óticas para se adaptar às diferentes necessidades da zona a iluminar.

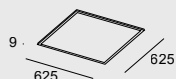

## Ecofit Plus Standard

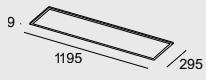
Ejemplo de código / Exemplo de código: **AP11-35W8MP0314**

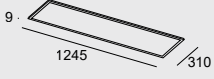
Model	W	K / CRI / Real lm	Optics	Source	Finishes
<b>AP11 -</b> Square / 60 × 60 IP40  	<b>35</b> 32.8W	<b>W8</b> 3000K / CRI 80 / 3697 lm	<b>MP</b> Microprisma	<b>O3</b>  EMERGENCY ON-OFF 220-240V	<b>14</b> 
		<b>W9</b> 3000K / CRI 90 / 3364 lm			
		<b>X8</b> 4000K / CRI 80 / 3851 lm			
		<b>X9</b> 4000K / CRI 90 / 3504 lm			
<b>AP12 -</b> Square / 62,5 × 62,5 IP40  					
<b>AP13 -</b> Rectangular / 119,5 × 29,5 IP40  					
<b>AP14 -</b> Rectangular / 124,5 × 31 IP40  					

**Ecofit Plus**   **Ecofit Plus**   **Ecofit Plus**   **Ecofit Plus 625**  
**600 × 600mm**   **1200 × 300mm**   **1245 × 308mm**   **x 625mm**



**Fuentes de alimentación**  
**Fontes de alimentação**

P. DER



Florón suspendido con toma de corriente Emergency 14 ○  
 Florão suspenso com tomada de corrente  
 Emergency

**71-A223-14-00**   **71-A223-14-00**   **71-A223-14-00**   **71-A223-14-00**

**Ecofit Opticell**   **Ecofit Opticell**   **Ecofit Opticell**   **Ecofit Opticell**  
**1200 × 300mm**   **625 × 625mm**   **600 × 600mm**   **1245 × 308mm**



**Fuentes de alimentación**  
**Fontes de alimentação**







P. DER

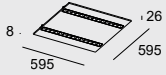

Florón suspendido con toma de corriente Emergency 14 ○  
 Florão suspenso com tomada de corrente  
 Emergency

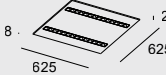
**71-A223-14-00**   **71-A223-14-00**   **71-A223-14-00**   **71-A223-14-00**

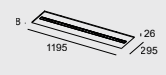
Ejemplo de código / Exemplo de código: **AQ11-3PW8F30314**

Model	W	K / CRI / Real lm	Optics	Source	Finishes
<b>AQ11 -</b> Square / 59,5 × 59,5 IP40  	<b>3P</b> 32.3W	<b>W8</b> 3000K / CRI 80 / 4402 lm <b>W9</b> 3000K / CRI 90 / 3962 lm <b>X8</b> 4000K / CRI 80 / 4596 lm <b>X9</b> 4000K / CRI 90 / 3962 lm	<b>F3</b> Opticell	<b>O3</b> EMERGENCY ON-OFF 220-240V  <b>D3</b> EMERGENCY DALI-2 220-240V	<b>14</b>
<b>AQ12 -</b> Square / 62 × 62 IP40  					
<b>AQ13 -</b> Rectangular / 119,5 × 29,5 IP40  					
<b>AQ14 -</b> Rectangular / 124,5 × 31 IP40  					

# Kits de emergencia

# Kits de emergência

Los Kits de conversión permiten que una luminaria pueda funcionar durante un tiempo predeterminado como iluminación auxiliar a la iluminación de emergencia.

Os Kits de conversão permitem que uma luminária possa funcionar durante um tempo predeterminado como iluminação auxiliar à iluminação de emergência.

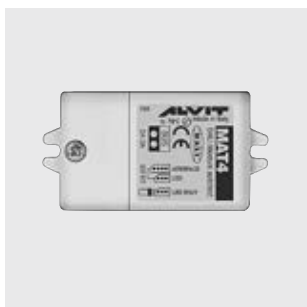

## Autotest

Si

Kit autotest + DALI compatible para 1h y 3h  
Kit autoteste + DALI compatível para 1h e 3h



DALI

## Code

**EM06-0001**



IP	Class	V <sub>in</sub>	Frecuency	V <sub>out</sub> emergency mode	I <sub>out</sub> emergency mode	h	Battery	Code
20	2	220-240V	50-60 Hz	10-48V	350-100mA	1h	Ni-Cd	<b>EM06-0002</b>
20	2	220-240V	50-60Hz	10-48V	200-60mA	3h	Ni-Cd	<b>EM06-0003</b>

## Compatible con / Compatível com

Módulos lumínicos con un rango de tensión de entrada entre 10 y 48V.

Módulos lumínicos com um intervalo de tensão de entrada entre 10 e 48V.

## Flujo lumínico en modo de emergencia batería 1h

### Fluxo lumínico em modo de emergência batería 1h

Power	10W	15W	20W	25W	30W	40W	50W
%	60%	40%	30%	25%	20%	15%	10%

## Flujo lumínico en modo de emergencia batería 3h

### Fluxo lumínico em modo de emergência batería 3h

Power	10W	15W	20W	25W	30W	40W	50W
%	35%	24%	18%	14%	12%	9%	7%

\*Valores referenciados a 36V, consultar con nuestro equipo comercial para otras configuraciones de tensión de entrada Vin.

\*Valores referenciados a 36V, consultar a nossa equipa comercial para outras configurações de tensão de entrada Vin.







Soluciones  
Conectivas  
Soluções  
Conectivas

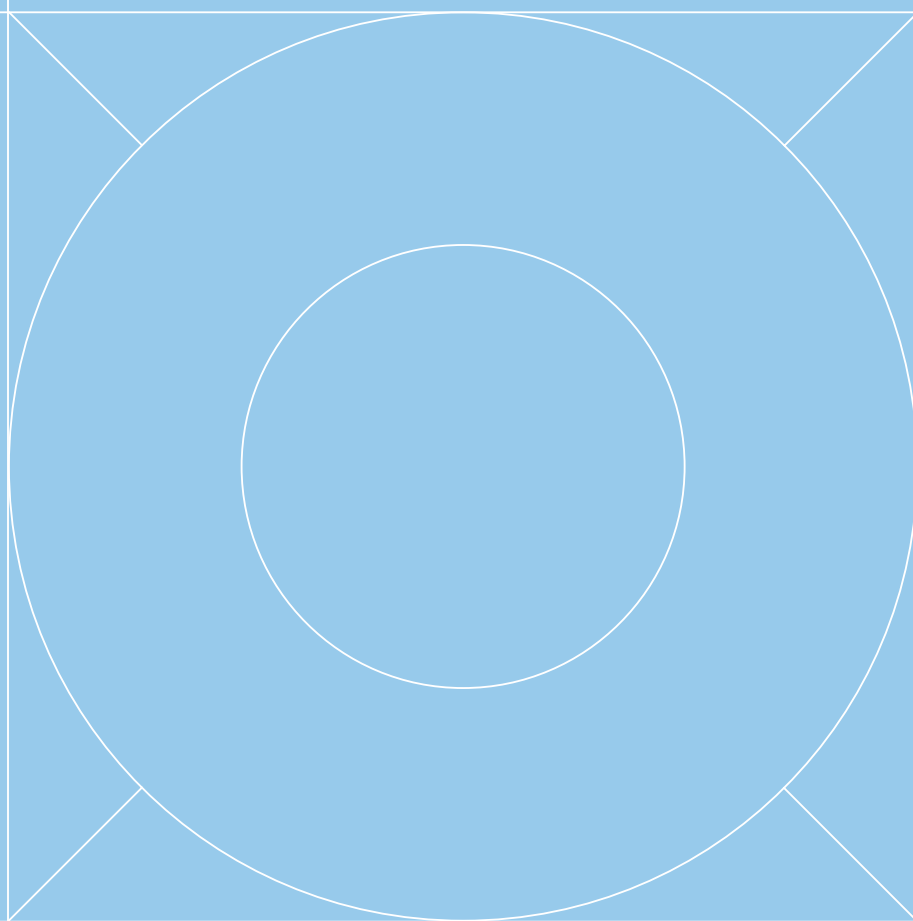

Solución para el control y la conectividad de la iluminación en un espacio donde se requiera la utilización eficiente de los recursos. Basada en el estándar D4i permite que cualquier driver con esta tecnología sea compatible con esta plataforma. Además de ofrecer funcionalidades de control, permite tener monitorizado el sistema mediante la plataforma y así poder obtener datos de ocupación y de uso del espacio.

Solução para o controlo e a conectividade da iluminação num espaço onde se requer a utilização eficiente dos recursos. Baseada no standard D4i permite que qualquer driver com esta tecnologia seja compatível com esta plataforma. Além de oferecer funcionalidades de controlo, permite ter monitorizado o sistema mediante a plataforma e assim poder obter dados de ocupação e de utilização do espaço.

## Funcionalidades

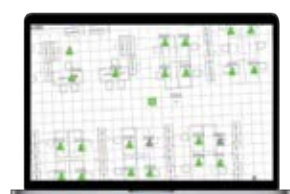

- Comunicación inalámbrica de las luminarias con acceso a internet  
Comunicação sem fios das luminárias com acesso à internet
- Control remoto  
Controlo remoto
- Estado de la instalación  
Estado da instalação
- Definición de perfiles y grupos  
Definição de perfis e grupos



- Ahorro por luz natural, por ocupación y por ajuste de tarea  
Poupança pela luz natural, por ocupação e por ajuste de tarefa
- Reportes de energía adaptados a las necesidades de cada acción realizada  
Relatórios de energia adaptados às necessidades de cada ação realizada
- Monitorización en tiempo real  
Monitorização em tempo real



- Información de la temperatura ambiente y de la luminaria para facilitar la integración con los sistemas de aire acondicionado y calefacción  
Informação da temperatura ambiente e da luminária para facilitar a integração com os sistemas de ar condicionado e aquecimento







- Gestión de alarmas  
Gestão dos alarmes
- Notificaciones por correo electrónico programables en función de varios parámetros como fallo de luminarias o sobrecalentamientos, actualizaciones disponibles, etc.  
Notificações por correio eletrónico programável em função de vários parâmetros como avaria de luminárias ou sobreaquecimentos, atualizações disponíveis, ...



- Informes de mapas de calor para una correcta gestión de los espacios y evaluación de los mismos  
Relatórios de mapas de calor para uma correta gestão dos espaços e avaliação dos mesmos

## Dispositivos D4i

### Dispositivos D4i

		L x W x H mm	V in F (Hz)	Lum. max.	Protocol	Code
	Controlador-Gestor Plataforma D4i Gestor Plataforma D4iControlador	198 x 145 x 42	120-240V 50-60Hz	1500 Sensors	-	<b>71-8063-00-00</b>
	Fuente de Alimentación PoE Fonte de Alimentação PoE	235 x 103 x 27	48V	-	PoE	<b>71-8064-00-00</b>
	Sensor Gateway Sensor Gateway	35 x 101,9 x 76,5	PoE	125 Sensors	IEEE 802.15.4	<b>71-8061-00-00</b>
	Multisensor Conectivo Multissensor Conectivo	27 x 18	D4i	4 Drivers	D4i	<b>71-8056-00-00</b>
	Multisensor Pro Multissensor Pro	27 x 18	D4i	4 Drivers	D4i	<b>71-8057-00-00</b>
	Multisensor Negro Connected Track Multissensor Preto Connected Track	120 x 40 x 35	220-240V 50-60Hz	4 Drivers	D4i	<b>35-A075-60-00</b>
	Multisensor Connected Track Multissensor Connected Track	120 x 40 x 35	220-240V 50-60Hz	4 Drivers	D4i	<b>35-A075-14-00</b>
	Botonera conectiva Botoneira conectiva	66,4 x 32,7 x 11,5	Battery CR2032	-	IEEE 802.15.4	<b>71-8062-00-00</b>
	Actualización multisensor conectivo Pro Atualização multissensor conectivo Pro	-	-	-	Software	<b>71-8060-00-00</b>
	Accesorio empotrar techo para Sensor D4i Acessório encastrar teto para Sensor D4i	20,7 x 13	-	-	-	<b>71-8058-00-00</b>
	Accesorio superficie techo para Sensor D4i Acessório superficie teto para Sensor D4i	25 x 35 x 67	-	-	-	<b>71-8059-00-00</b>

# DALI2

Solución para el control y la conectividad basada en el estándar DALI2.  
Solução para o controlo e conectividade da Solução de controlo de iluminação baseada no standard DALI2.

## Funcionalidades

Permite conseguir, en una instalación, un gran ahorro energético mediante funcionalidades como gestión de luminarias punto a punto, grupos, escenas, control de luz constante, ciclo circadiano, control por ocupación y programaciones horarias, entre otras. Permite el cálculo de las horas de funcionamiento y el consumo de cada luminaria y así poder hacer un mantenimiento preventivo reactivo. Las alarmas de fallos pueden enviarse a un correo electrónico. Al tratarse de una programación personalizada para cada necesidad, las posibilidades son ilimitadas. La programación se realiza mediante un software de programación in situ, o mediante web server.

Permite conseguir, numa instalação, uma grande poupança energética mediante funcionalidades como gestão de luminárias ponto a ponto, grupos, cenas, controlo de luz constante, ciclo circadiano, controlo por ocupação e programações horárias, entre outras. Permite o cálculo das horas de funcionamento e o consumo de cada luminária e assim poder fazer uma manutenção preventiva reativa. Os alarmes de falhas podem ser enviados para um correio eletrónico. Ao tratar-se de uma programação personalizada para cada necessidade, as possibilidades são ilimitadas. A programação realiza-se mediante um software de programação in situ, ou mediante web server. Dentro desta programação também é possível visualizar em plano a instalação e luminárias de forma real e atualizada.



CNTEC, Girona 2020.

**Elige la opción más adecuada a tu proyecto**  
**Escolha a opção mais adequada ao seu projeto**

① Essential

② Performance

③ Advanced

①

— Calendario, grupos, escenas, sensores de presencia y luminosidad  
Calendário, grupos, cenas, sensores de presença e luminosidade

— Ciclo circadiano y luminarias Tunnable White  
Ciclo circadiano e luminárias Tunnable White

— Compatible con licencia para luminarias de emergencia  
Compatível com licença para luminárias de emergência

②









— Compatible con licencia BACnet  
Compatível com licença BACnet

③

— Sistema enlazable hasta 5 controladores Advance (permite visualizar como 1 único controlador)  
Sistema conectável até 5 controladores Advance (permite visualizar como 1 único controlador)

## Dispositivos DALI2

### Dispositivos DALI2

		L x W x H mm	IP	V in F (Hz)	Lums. max.	W max	Protocol	Code
	Controlador DALI2 Essential Controlador DALI2 Essential	160 x 91 x 62	20	110-240 V 50-60 Hz	64 x 3 OUTPUT DALI2	DALI BUS OUTPUT 200 mA x3	DALI2	<b>71-B102-00-00</b>
	Controlador DALI2 Performance Controlador DALI2 Performance	160 x 91 x 62	20	110-240 V 50-60Hz	64 x 3 OUTPUT DALI2	DALI BUS OUTPUT 200 mA x3	DALI2	<b>71-B103-00-00</b>
	Controlador DALI2 Advance Controlador DALI2 Advance	160 x 91 x 62	20	110-240 V 50-60 Hz	64 x 3 OUTPUT DALI2	DALI BUS OUTPUT 200 mA x3	DALI2	<b>71-B104-00-00</b>
	Sensor DALI2 empotrar Sensor DALI2 encastrar	46,7 Ø 58 x 65,4	20	DALI2 9,5-22,5 V	-	9 mA	DALI2	<b>71-B098-00-00</b>
	Sensor DALI2 superficie Sensor DALI2 superficie	96,3 Ø x 36,6	20	DALI2 9,5-22,5 V	-	9 mA	DALI2	<b>71-B100-00-00</b>
	Convertor 4 señales digitales Convertor 4 sinais digitais	7,7 x 28,2 x 14,6	20	DALI2 9,5-22,5 V	-	10 mA	DALI2	<b>71-B099-00-00</b>
	Rele actuador DALI Relé atuador DALI	92,5 x 62	20	220-240 V 50/60 Hz	-	2 mA / 6A	DALI2	<b>71-B101-00-00</b>
	Licencia BACnet 500 variables Licença BACnet 500 variáveis							<b>71-B118-00-00</b>
	Licencia Emergencia 100 luminarias Licença Emergência 100 luminárias							<b>71-B117-00-00</b>



# Bluetooth Casambi

Solución de control de iluminación basada en el protocolo Bluetooth Mesh con control directo desde Smartphone o Tablet, sin necesidad de añadir ningún elemento adicional. La facilidad de uso del sistema permite que sea válida para cualquier usuario. Su aplicación es ideal para entornos flexibles y dinámicos, donde se requiera una gran interacción con las luminarias.

Solução de controlo de iluminação baseada no protocolo Bluetooth Mesh com controlo direto desde Smartphone ou Tablet, sem necessidade de adicionar nenhum elemento adicional. A facilidade de uso do sistema permite que seja válida para qualquer utilizador. A sua aplicação é ideal para ambientes flexíveis e dinâmicos, onde seja necessária uma grande interação com as luminárias.



Brondesbury Park Synagogue, London 2022.

## Funcionalidades

### Funcionalidades



- Control individual de las luminarias y regulación punto a punto  
Controlo individual das luminárias e regulação ponto a ponto
- Creación de grupos de luminarias  
Criação de grupos de luminárias
- Regulación según calendario  
Regulação segundo calendário
- Control de la temperatura de color  
Controlo da temperatura de cor
- Ciclo circadiano  
Ciclo circadiano
- Regulación según nivel de luz natural  
Regulação segundo o nível de luz natural

**Bluetooth Low energy**  
**Bluetooth Low energy**

Solución basada en tecnología Bluetooth, es la misma tecnología ya integrada en los dispositivos móviles smartphones o tablets. Esto permite una comunicación directa entre luminaria/controlador y dispositivo móvil, sin necesidad de añadir ningún elemento físico adicional para su control.

Solução baseada na tecnologia Bluetooth, é a mesma tecnologia já integrada nos dispositivos móveis smartphones ou tablets. Isso permite uma comunicação direta entre luminária/controlador e o dispositivo móvel, sem necessidade de adicionar nenhum elemento físico adicional para o seu controle.

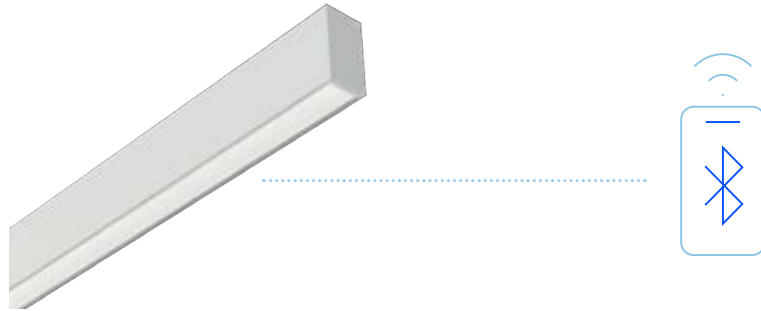

**Wireless Mesh Network**  
**Wireless Mesh Network**

Sistema escalable que permite crear una red de información (nodos) a medida que se van añadiendo dispositivos. La inteligencia del sistema se replica en cada nodo, de forma que si un nodo desaparece, el resto del sistema sigue funcionando. Gracias a este sistema en malla y la tecnología Bluetooth, no es necesario una conexión a Internet para un control local.

Sistema escalável que permite criar uma rede de informação (nós) à medida que os dispositivos vão sendo adicionados. A inteligência do sistema é replicada em cada nó, para que, se um nó desaparecer, o resto do sistema continue a funcionar. Graças a este sistema em rede e à tecnologia Bluetooth, não é necessária uma ligação à Internet para um controlo local.



**Ecosistema Casambi**  
**Ecosystema Casambi**

El ecosistema Casambi permite una gran interoperabilidad entre diferentes productos como: sensores, interruptores, etc.

O ecossistema Casambi permite uma grande interoperabilidade entre diferentes produtos como: sensores, interruptores, etc.

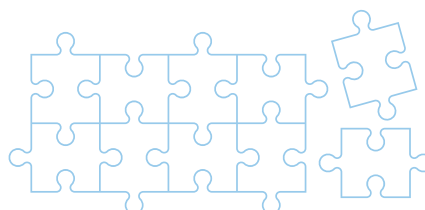

## Dispositivos Bluetooth Casambi

### Dispositivos Bluetooth Casambi

		L x W x H mm	IP	V in F (Hz)	Lums. DALI	W max	Protocol	Code
	Regulador 0-10V - DALI Regulador 0-10V - DALI	56 x 36 x 22	20	220-240V 50-60Hz	1	-	0-10 / DALI	<b>71-5961-00-00</b>
	Regulador trailing edge Regulador trailing edge	40 x 36 x 14	20	100-240V 50-60Hz	1	150W	Trailing edge	<b>71-5959-00-00</b>
	Regulador 4 ch PWM Regulador 4 ch PWM	2,6 x 30 x 18	20	12-24V DC	1	72W 12V DC, 144W 24V DC	PWM 4 canales	<b>71-8050-00-00</b>
	Regulador 1 ch PWM Regulador 1 ch PWM	4,5 x 58 x 19	20	100-240V 50-60Hz	1	120W 12V DC, 240W 24V DC	PWM 1 canal	<b>71-A857-00-00</b>
	Fuente alimentación PWM de 1 canal 24V Fonte de alimentação PWM de 1 canal 24V	191 x 63 x 37,5	67		1	120W 24V	PWM 1 canal	<b>71-A242-00-00</b>
	Caja IP65 Fuente de alimentación y regulador PWM 4 ch Caixa IP65 Fonte de alimentação e regulador PWM 4 canais	253 x 342 x 132	65	100-277V 50-60Hz		144W, 24V DC	PWM 4 canales	<b>71-E300-00-00</b>
	Regulador DALI Broadcast Regulador DALI Broadcast	38 x 38 x 26	64	100-240V 50-60Hz	50	100mA DALI	DALI Dt8 Broadcast	<b>71-A301-00-00</b>
	Regulador DALI Broadcast 8 grupos Regulador DALI Broadcast 8 grupos	180 x 42 x 25	20	24-48V DC	64	250mA Bus DALI	DALI 8 grupos Bus DALI	<b>71-A239-00-00</b>
	Regulador DALI Broadcast Track Low Voltage Regulador DALI Broadcast Track Low Voltage	113 x 18 x 59	20	24-48V DC	64	250mA Bus DALI	DALI Broadcast	<b>71-8115-00-00</b>
	Regulador DALI Broadcast a carril blanco Regulador DALI Broadcast para calha branca	113 x 45 x 124	20	100-240V 50-60Hz	64	250mA Bus DALI	DALI Broadcast	<b>71-A243-14-14</b>
	Regulador DALI Broadcast a carril negro Regulador DALI Broadcast para calha preta	113 x 45 x 124	20	100-240V 50-60Hz	64	250mA Bus DALI	DALI Broadcast	<b>71-A243-60-60</b>
	Convertor DALI Broadcast IP66 Convertor DALI Broadcast IP66	108 x 62 x 108	66	100-240V 50-60Hz	64	150mA Bus DALI	DALI Broadcast	<b>71-A237-00-00</b>
	Convertor DMX Broadcast IP66 Convertor DMX Broadcast IP66	108 x 62 x 10	66	100-240V 50-60Hz	-	-	DMX Broadcast	<b>71-A238-00-00</b>
	Pasarela sistema Casambi a DALI Passarela sistema Casambi a DALI	40 x 36 x 14	20	9,5-22,5V DC	-	DALI	-	<b>71-8051-00-00</b>
	Rele On Off Rele On Off	50 x 120 x 32	40	100-240 50-60Hz	-	1500 W	On Off	<b>71-A300-00-00</b>

		L x W x H mm	IP	V in F (Hz)	Lums. DALI	W max	Protocol	Code
	Sensor empotrar Luminosidad y presencia con salida DALI Sensor encastrar Luminosidade e presença com saída DALI	Ø 76 x 69	40	230V 50Hz	10	1500W, 20mA bus DALI	DALI Broadcast	<b>71-A696-00-00</b>
	Sensor empotrar de presencia y luminosidad Sensor de presença e luminosidade	Ø 85 x 88	20	220-240V 50Hz	-	-	-	<b>71-8049-00-00</b>
	Sensor de presencia y luminosidad a carril trifásico Sensor de presença e luminosidade em calha trifásica preta	70 x 59 x 39	IP20	220-240V 50Hz	-	-	-	<b>71-A241-60-60</b>
	Sensor de presencia y luminosidad a carril trifásico Sensor de presença e luminosidade em calha trifásica branca	70 x 59 x 39	20	220-240V 50Hz	-	-	-	<b>71-A241-14-14</b>
	Botonera Casambi negra Botoneira Casambi preta	90 x 90 x 12	20	Bateria CR2430	-	-	-	<b>71-8053-00-00</b>
	Botonera Casambi blanca Botoneira Casambi branca	90 x 90 x 12	20	Bateria CR2430	-	-	-	<b>71-A240-00-00</b>
	Botonera Enocean 1 botón Blanca Botoneira EnOcean 1 botão branca	80 x 86 mm	20	-	-	-	-	<b>71-B113-00-00</b>
	Timer Casambi para programaciones horarias Timer Casambi para programações horárias	45 x 58 x 25	20	45 x 12-48 x 25	-	-	-	<b>71-8052-00-00</b>
	Fuente de alimentación 12W a 12V Fonte de Alimentação 12W a 12V	Ø 51 x 28	20	220-240V	-	-	-	<b>71-B416-00-00</b>
	Convertor 4 Señales digitales Convertor 4 Sinais digitais	Ø 53 x 21	20	230V 50Hz	-	max.10 mA	Entradas digitales libres de potencial Entradas digitais livres de potencial	<b>71-A302-00-00</b>

# DMX

Sistema de control DMX que permite una gestión de la iluminación dinámica con unas transiciones de color a alta velocidad, permitiendo incluso un posible control punto a punto de cada luminaria.

Sistema de controlo DMX que permite a gestão dinâmica da iluminação com transições de cor de alta velocidade, permitindo inclusive o controlo ponto a ponto de cada luminária.

## Funcionalidades



Puente de los Remedios, Villafranca de Cordoba 2022

**Elige la opción más adecuada a tu proyecto**  
**Escolha a opção mais adequada ao seu projeto**

① Essential

② Performance

— Control Luminarias DMX RGB o RGBW  
 Controlo Luminárias DMX RGB ou RGBW

— 1 universo DMX-RDM 512  
 1 universo DMX-RDM 512

— Wifi

— 36 Escenas  
 36 Cenas

— Programaciones horarias y calendario  
 Programações horárias e calendário

① — Programación por APP  
 Programação por APP

— 2 universos DMX-RDM 1024  
 2 universos DMX-RDM 1024





— Hasta 500 escenas  
 Até 500 cenas

— Ethernet

② — Acceso remoto  
 Acesso remoto

## Dispositivos DMX

### Dispositivos DMX

		L x W x H mm	IP	V in F (Hz)	Lums. DMX	W max	Protocol	Code
	Consola DMX Essential Consola DMX Essential	146 x 106 x 11	20	100-240V 50-60Hz	170 RGB 128 RGBW	DMX 512	1024 Channels	<b>71-B115-00-00</b>
	Consola DMX Performance Consola DMX Performance	146 x 106 x 11	20	100-240V 50-60Hz	340 RGB 256 RGBW	DMX 1024	1024 Channels	<b>71-B116-00-00</b>
	Divisor 4 señales DMX Divisor 4 sinais DMX	72 x 92 x 62	20	12-24-48V DC	1	DMX 512 + RDM	4 output DMX	<b>71-B125-00-00</b>
	Regulador PWM RGBW Regulador PWM RGBW	153 x 65 x 20	20	12-24V 50-60Hz	1	12V 24W 24V 48W DMX 512	4 Channels	<b>71-3493-00-00</b>
	Fuente de alimentación 12W a 12V Fonte de alimentação 12W a 12V	Ø 51 x 28	20	220-240V	-	-		<b>71-B416-00-00</b>



# Light for Life

Solución de control de iluminación basada en la tecnología inalámbrica bluetooth/ wi-fi\*, dependiendo de la tipología de producto. Permite el control directo con smartphone, mediante la App Light for Life, una aplicación rápida y fácil de usar. El sistema, además, es compatible con los principales asistentes de voz.

Solução de controlo de iluminação baseada em tecnologia sem fios bluetooth/ wi-fi\*, dependendo da tipologia do produto. Permite o controlo direto com smartphone, mediante a App Light for Life, uma aplicação rápida e fácil de usar. O sistema é compatível também com os principais assistentes de voz.



## Funcionalidades



### Funcionalidades



- Control individual de las luminarias directamente desde un smartphone  
Controlo individual das luminárias diretamente desde um smartphone
- Control de la temperatura de color y RGB de las luminarias  
Controlo da temperatura da cor e RGB das luminárias
- Creación de escenas para ajustar la atmósfera ideal a cada momento  
Criação de cenas para ajustar a atmosfera ideal a cada momento
- Programaciones horarias para activaciones automáticas.  
Programações horárias para ativações automáticas





**Accesorios Light for Life**  
**Accesórios Light for Life**

		L x W x H mm	IP	V in F (Hz)	Lum. max.	W max.	Protocol	Code
	Regulador O/1-10V o DALI Regulador O/1-10V ou DALI	100 x 38 x 21	20	110-240V 50-60Hz	0-10V: max 10 DALI: max 20	0-10V: max 1000W (220V) max 500W (110V)	O/1-10V DALI	<b>71-8218-00-00</b>
	Relé ON/OFF Relé ON/OFF	88 x 39 x 23	20	110-240V 50-60Hz	-	1100W for 110V	On-Off	<b>71-A189-00-00</b>

		LED	Tc	P (W)	Lm	V	Hz	Protocol	Optics	Code
	Bombilla E27 RGBW Wifi Lâmpada E27 RGBW Wifi	E27	RGBW	12	950*	220-240V	50Hz	Light for Life	180°	<b>71-8219-00-00</b>
	Bombilla GU10 TW Wifi Lâmpada GU10 TW Wifi	GU10	TW	5	345*	220-240V	50Hz	Light for Life	180°	<b>71-8220-00-00</b>
	Bombilla E14 TW Wifi Lâmpada E14 TW Wifi	E14	TW	5	470*	220-240V	50Hz	Light for Life	200°	<b>71-8221-00-00</b>

# Standalone

Soluciones de control autónomas. Pueden utilizarse para controlar una o varias luminarias dentro de un mismo espacio de forma autónoma. Con las soluciones Standalone podemos realizar funciones sencillas y conseguir un gran ahorro energético.

Soluções de controlo autónomas. Podem ser utilizadas para controlar uma ou várias luminárias dentro de um mesmo espaço de forma autónoma. Com as soluções Standalone podemos realizar funções simples e conseguir uma grande poupança energética.

## Institut Vilabreix, 2022



Gracias a la incorporación de sensores autónomos, la iluminación se regula en función del aporte de luz natural, favoreciendo el ahorro energético.

Graças à incorporação de sensores autónomos, a iluminação é regulada de acordo com o fornecimento de luz natural, favorecendo a poupança energética.







## Sensores

### Sensores





		L x W x H mm	V in F (Hz)	mA	Lums. max.	W max	Protocol	Code
	Multisensor DALI autónomo Multisensor DALI autónomo	80 x 50	95-250V 50-60Hz	-	16	DALI BUS OUTPUT 35mA max	DALI	<b>71-8067-00-00</b>
	Sensor de movimiento ON OFF Sensor de movimento ON OFF	80 x 50	95-250 Vac 50-60 Hz	-	-	6A	ON OFF / RELE	<b>71-B368-00-00</b>

## Botoneras





### Botoneras

		L x W x H mm	RGB White	V in F (Hz)	Lums. máx.	W max	Protocol	Code
	Regulador DALI Regulador DALI	80 x 80 x 53	White	100-240V 50-60Hz	50	DALI BUS OUTPUT 100mA max	DALI	<b>71-7671-00-00</b>
	Botonera DALI i DALI DT8 TW Botoneira DALI i DALI DT8 TW	71 x 71 x 50	DALI (White) DALI Dt8 (TW)	220-240V 50-60Hz	25	2W 52mA	DALI2	<b>71-B361-00-00</b>
	Controlador DMX Controlador DMX	86 x 86 x 42	RGB	100-240V 50-60Hz	-	-	DMX	<b>71-7666-00-00</b>
	Controlador PWM Controlador PWM	86 x 86 x 32	RGB	12-24	-	240W @ 12V 480W @24V	PWM	<b>71-7664-00-00</b>

**Mandos y reguladores RF**  
**Mandos y reguladores RF**

	L x W x H mm	RGB White	V in F (Hz)	Lums. máx.	W max	Protocol	Code
 <b>Controlador blanco mando</b> Controlador branco mando	140 x 48 x 17	White	Battery 3xAAA	869,5 / 916,5 / 434 MHz	-	RF	<b>71-7670-00-00</b>
 <b>Controlador blanco receptor</b> Controlador branco receptor	95 x 37 x 20	White	12-36	869,5 / 916,5 / 434 MHz	96W @ 12V 192W @ 24V	PWM	<b>71-7668-00-00</b>
 <b>Controlador RGB mando</b> Controlador RGB mando	140 x 48 x 17	RGB	Battery 3xAAA	869,5 / 916,5 / 434 MHz	-	RF	<b>71-7667-00-00</b>
 <b>Controlador RGB receptor</b> Controlador RGB receptor	178 x 46 x 22	RGB	12-48	869,5 / 916,5 / 434 MHz	240W @ 12V 480W @ 24V	PWM	<b>71-7669-00-00</b>

**Standalone Ready to**

	L x W x H mm	V in F (Hz)	mA	Lums. máx.	W max	Protocol	Code
 <b>Sensor de presencia y luminosidad autonomo D4i</b> Sensor de presença e luminosidade autónomo D4i	Ø 22 (cut) Ø 30 x 43,5	12-22,5 V DC	-	4	-	D4i / Bluetooth	<b>71-A723-00-00</b>
 <b>Acoplador DALI</b> Acoplador DALI2	78 x 78	95-250V 50-60Hz	-	16	DALI BUS OUTPUT 35mA max	DALI	<b>71-8069-00-00</b>
 <b>Frontal botonera DALI 4 funciones</b> Frontal botoneira DALI 4 funções	86 x 86 x 8,5	-	-	-	-	-	<b>71-8070-00-00</b>
 <b>Frontal botonera DALI 9 funciones</b> Frontal botoneira DALI 9 funções	86 x 86 x 8,5	-	-	-	-	-	<b>71-8071-00-00</b>
 <b>Controlador DALI</b> Controlador DALI	86 x 86 x 42	White	100-240 50-60Hz	50	DALI BUS OUTPUT 100mA max	DALI	<b>71-7665-00-00</b>

Pide tu botonera o sensor con las escenas luminicas que necesitas.  
 Peça a sua botoneira ou sensor com as cenas luminicas que precisar.

# Electrical Units & Accessories

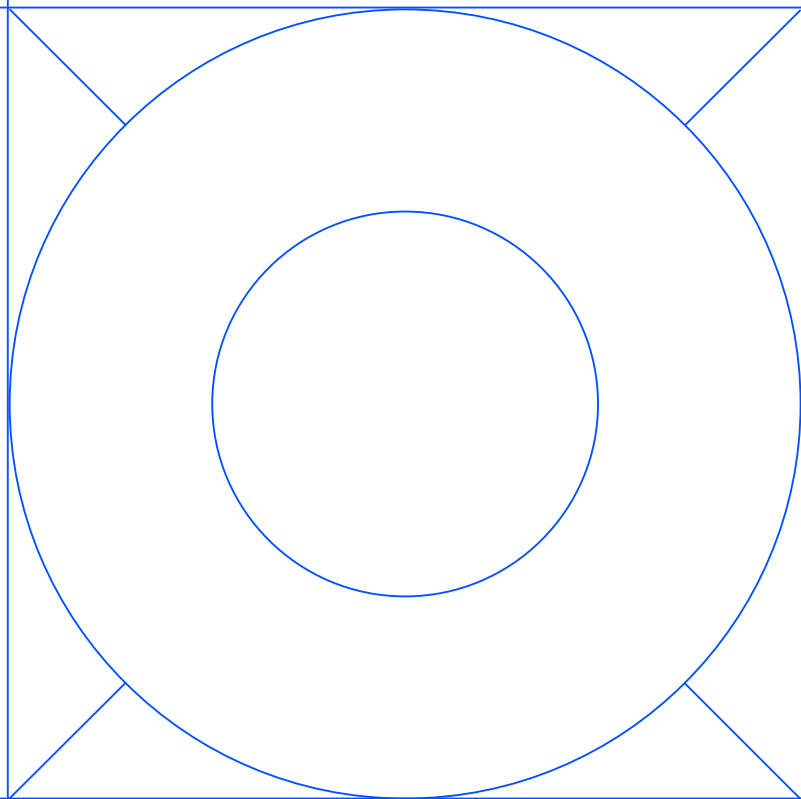

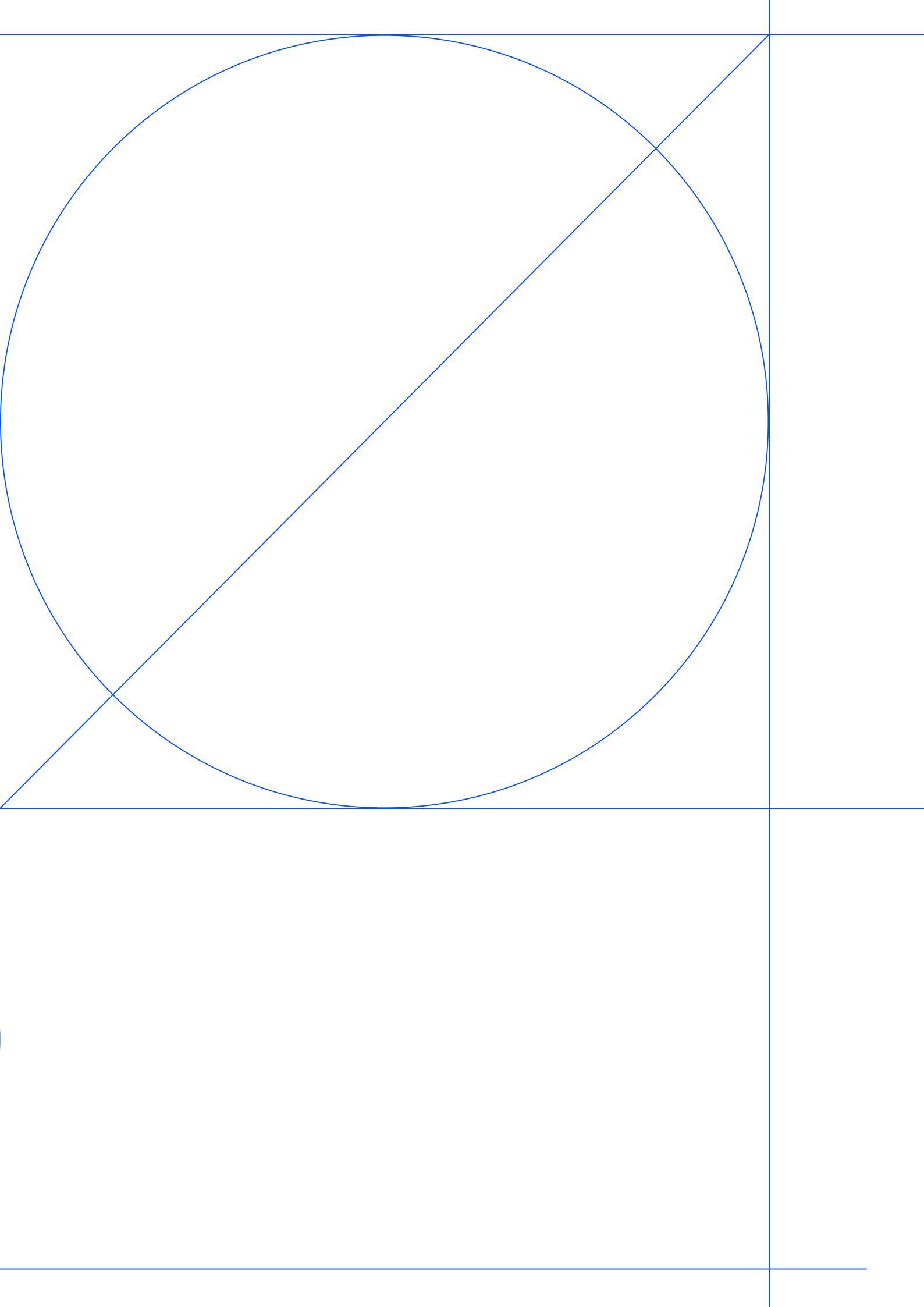

## Recomendaciones de instalación

### Recomendações de instalação

#### Productos con driver remoto

Se recomienda instalar el driver a un máximo de 2 metros del producto cuando no sea posible verificar los niveles de EMC de cada aplicación, según lo establecido en las normas de referencia. Es necesario verificar la polaridad de los cables del producto antes de conectarlos al secundario del driver, ya que un mal conexionado puede dañar el módulo LED y/o el driver.

#### Regulación

Los cables de señal de regulación deben instalarse separados de los cables de potencia. No está permitido poner interruptores en el secundario del driver.

#### Regulación por línea (corte de fase)

- Regulación básica por línea, no requiere cables adicionales.
- Productos con driver de regulación tipo "L": admiten regulación con dimmers tipo TRIAC/IGBT; regulación por inicio de fase (leading edge/forward phase control).
- Productos con driver de regulación tipo "C": admiten regulación con dimmers tipo IGBT; regulación por final de fase (trailing edge/reverse phase control).
- Productos con driver tipo "LC" admiten los dos tipos de dimmers especificados anteriormente.
- Se recomienda verificar la compatibilidad dimmer-driver.

#### Regulación Push

Requiere un cable adicional. Deben utilizarse pulsadores NA (normalmente abiertos). Una pulsación rápida enciende o apaga el producto. Si se mantiene accionado el pulsador se ajusta el nivel de brillo.

#### Regulación 0/1-10V

Regulación analógica que requiere dos cables adicionales con polaridad. Un dimmer genera una señal a tensión constante entre 0 y 10V. Si se aplica una tensión de 1V el driver ajustará el brillo del producto al mínimo, sin embargo cuando se aplique una tensión de 10V el producto brillará al máximo. Los drivers que admiten una señal de regulación con rango entre 0-10V son capaces de apagar el producto por completo al recibir 0V del dimmer.

#### Control DALI/DALI-2

Protocolo de control digital desarrollado por los principales fabricantes de drivers para crear un estándar de regulación en el sector de la iluminación. Permite memorizar escenas, enviar mensajes en caso de fallo o final de vida del producto, control y planificación punto a punto del producto y gestión de emergencias. Requiere dos cables adicionales sin polaridad. Se recomienda utilizar cable de sección 1.5mm<sup>2</sup>. La certificación DALI-2 mejora la interoperabilidad entre dispositivos DALI.

#### Control DMX

Protocolo de control digital utilizado en el mundo de la iluminación espectacular. Requiere dos cables adicionales con polaridad. Se recomienda el uso de cable trenzado, apantallado y con impedancia 120Ω

#### Control Casambi

Sistema de control Bluetooth Mesh  
Se recomienda no superar los 15m de distancia entre dispositivos, ni utilizar envolventes metálicas que afecten a su comunicación inalámbrica.

#### Produtos com driver remoto

Recomenda-se instalar o driver no máximo a 2 metros do produto quando não for possível verificar os níveis de EMC de cada aplicação, conforme o estabelecido nas normas de referência. É necessário verificar a polaridade dos cabos do produto antes de os conectar ao secundário do driver, já que uma má conexão pode danificar o módulo LED e/ou o driver.

#### Regulação

Os cabos de sinal de regulação devem ser instalados separados dos cabos de potência. Não é permitido colocar interruptores no secundário do driver.

#### Regulação por linha (corte de fase)

- Regulação básica por linha, não requer cabos adicionais.
- Produtos com driver de regulação tipo "L": admitem regulação com dimmers tipo TRIAC/IGBT; regulação por início de fase (leading edge/forward phase control).
- Produtos com driver de regulação tipo "C": admitem regulação com dimmers tipo IGBT; regulação por final de fase (trailing edge/reverse phase control).
- Produtos com driver tipo "LC" admitem os dois tipos de dimmers especificados anteriormente.
- Recomenda-se verificar a compatibilidade dimmer-driver.

#### Regulação Push

Requer um cabo adicional. Devem ser utilizados botões NA (normalmente abertos). Uma pressão rápida liga ou desliga o produto. Mantendo-se o botão pressionado ajusta-se o nível de brilho.

#### Regulação 0/1-10V

Regulação analógica que requer dois cabos adicionais com polaridade. Um dimmer gera um sinal de tensão constante entre 0 e 10V. Se for aplicada uma tensão de 1V, o driver ajustará o brilho do produto no mínimo, contudo quando for aplicada uma tensão de 10V o produto brillará no máximo. Os drivers que admitem sinal de regulação com um intervalo entre 0-10V são capazes de desligar completamente o produto ao receber 0V do dimmer.

#### Controlo DALI/DALI-2

Protocolo de controlo digital desenvolvido pelos principais fabricantes de drivers para criar um standard de regulação no setor da iluminação. Permite a memorização de cenários, enviar mensagens em caso de falha ou fim de vida do produto, controlo e planificação ponto a ponto do produto e gestão de emergências. Requer dois cabos adicionais sem polaridade. Recomenda-se utilizar um cabo de secção de 1,5 mm<sup>2</sup>. A certificação DALI-2 melhora a interoperabilidade entre os dispositivos DALI.

#### Controlo DMX

Protocolo de controlo digital utilizado no mundo da iluminação espectacular. Requer dois cabos adicionais com polaridade. Recomenda-se o uso de cabo trançado, blindado e com impedância de 120Ω.

#### Controlo Casambi

Sistema de controlo Bluetooth Mesh  
Recomenda-se não ultrapassar os 15 m de distância entre dispositivos, nem utilizar envolventes metálicas que afetem a sua comunicação sem fios.



#### EMPOTRABLES DE TIERRA – DRENAJE

Es imprescindible seguir las instrucciones de montaje y la guía de instalación de los empotrables para lograr el mejor funcionamiento posible de la luminaria.

1. Evitar colocar las luminarias en zonas de depresión del terreno.
2. Evitar colocar las luminarias en zonas donde se pueda acumular agua y en ubicaciones permanentemente húmedas, como jardines o césped.
3. Evitar el uso de productos químicos utilizados para el abono de jardines ya que pueden deteriorar algunos componentes.
4. Nivelar la luminaria con el pavimento.
5. Prever un recubrimiento de dilatación en el caso de empotrables colocados en superficies como el cemento o el hormigón para evitar la posible dilatación o compresión.
6. Colocar un drenaje eficaz para evitar el estancamiento de agua, como mínimo de 25 centímetros de grava por debajo de la carcasa de instalación. Un drenaje correcto debe absorber hasta 10 litros de agua en 15 minutos.
7. Hacer funcionar la luminaria durante 20 minutos sin el cristal para evitar condensaciones de agua dentro.



#### ENCASTRÁVEIS NO SOLO – DRENAGEM

É imprescindível que siga as instruções de montagem e o guia de instalação dos encastráveis para obter o melhor funcionamento possível do aparelho de iluminação.

1. Evite colocar os aparelhos de iluminação em zonas de depressão do terreno.
2. Evite colocar os aparelhos de iluminação em zonas onde se possa acumular água e em localizações permanentemente húmidas, como jardins ou relva.
3. Evite o uso de produtos químicos utilizados para o adubamento de jardins, dado que eles podem deteriorar alguns componentes.
4. Nivele o aparelho de iluminação pelo pavimento.
5. Preveja um revestimento de dilatação no caso de encastráveis colocados em superfícies como o cimento ou o betão para evitar a eventual dilatação ou compressão.
6. Coloque uma drenagem eficaz para evitar a estagnação da água, no mínimo de 25 centímetros de gravilha abaixo da carcaça de instalação. Uma drenagem correcta deve absorver até 10 litros de água em 15 minutos.
7. Faça funcionar o aparelho de iluminação durante 20 minutos sem o vidro para evitar condensações de água dentro dele.



## Accesorios Smart / Accesorios Smart

		Tc	P (W)	Lm	V	Hz	Protocol	Optics	Code
	Bombilla E27 RGBW Wifi	RGBW	12	950*	220-240V	50Hz	Light for Life	180°	71-8219-00-00
	Bombilla GU10 TW Wifi	TW	5	345*	220-240V	50Hz	Light for Life	180°	71-8220-00-00
	Bombilla E14 TW Wifi	TW	5	470*	220-240V	50Hz	Light for Life	200°	71-8221-00-00

## Drivers



L x W x H mm	IP	CLASS	V in	Frecuencia Frequência	V out	Constant current Iout (mA)	Potencia máxima (W) Potência máxima (W)	Protocol	
127x38x28	20	□	110-240V	50-60Hz	2-24V	700mA	17	ON-OFF	71-3308-00-00
124x79x22	20	□	110-240V	50-60Hz	0-74V	350-1050mA	50	ON-OFF	71-3542-00-00
124x79x22	20	□	110-240V	50-60Hz	2-74V	350-1050mA	60	PUSH;0-10V;1-10V;DALI2	71-4706-00-00
124x79x22	20	□	110-240V	50-60Hz	2-74V	350-1050mA	50	PUSH;0-10V;1-10V	71-4708-00-00
166x47x35	20	□	220-240V	50-60Hz	2-47V	350-750mA	32	PHASE-CUT	71-4898-00-00
103x67x21	20	□	100-264V	50-60Hz	24V	350-1050mA	32	Not Dimmable	71-4913-00-00
129x76x30	20	□	99-264V	50-60Hz	48V	1050-2100mA	55	ON-OFF	71-4914-00-00
115x45x25	20	□	220-240V	50-60Hz	0	500mA	21	ON-OFF	71-6142-00-00
110,4x52x22	20	□	110-240V	50-60Hz	2-43V	250-700mA	20	DALI2	71-6192-00-00
123x45x19	20	□	100-240V	50-60Hz	23-46V	350mA	16,1	ON-OFF	71-6652-00-00
105x68x32	20	□	100-240V	50-60Hz	21-43V	700mA	30,1	ON-OFF	71-6653-00-00
115x29x45	20	□	100-240V	50-60Hz	10-29V	700mA	20,3	ON-OFF	71-6658-00-00
105x68x32	20	□	100-240V	50-60Hz	21-42V	1050mA	44,1	ON-OFF	71-6661-00-00
102x38x21	20	□	220-240V	50-60Hz	6-14V	700mA	10	PHASE CUT 240V	71-7663-00-00
115x34x19	20	□	100-240V	50-60Hz	0-43V	350mA	15	ON-OFF	71-7701-00-00
110,4x52x22	20	□	100-240V	50-60Hz	2-43V	350-900mA	20	1-10V;PUSH	71-7710-00-00
68,4x33,2x22	20	□	100-277V	50-60Hz	2,8-7V	700mA	4,9	ON-OFF	71-7712-00-00
50x40x22	20	□	90-264V	50-60Hz	2-8,5V	700mA	6	ON-OFF	71-7713-00-00
153x67x30,5	20	□	220-240V	50-60Hz	28-40V	1000mA	40	PHASE CUT 240V	71-7716-00-00
138x67x29,5	20	□	220-240V	50-60Hz	15-37V	700mA	27	DALI D4i;DALI2	71-7737-00-00
138x67x29,5	20	□	220-240V	20-60Hz	17-47V	700mA	35	DALI D4i;DALI2	71-7738-00-00
68x33x22	20	□	100-277V	50-60Hz	2,8-7V	500mA	3,5	ON-OFF	71-8048-00-00
68,4x33,2x22	20	□	100-277V	50-60Hz	2-7V	350mA	2,45	ON-OFF	71-8077-00-00
150x43x25	20	□	100-240V	50-60Hz	5-13V	700mA	9	DALI2;PUSH	71-A190-00-00
150x43x25	20	□	100-240V	50-60Hz	23-46V	350mA	16	DALI2;PUSH	71-A191-00-00
152x46x36	20	□	100-240V	50-60Hz	10-43V	350-700mA	30	DALI2;PUSH	71-A192-00-00
146,5x44x30	20	□	220-240V	50-60Hz	10-38V	350-1050mA	38	CASAMBI	71-A260-00-00
146,5x44x30	20	□	220-240V	50-60Hz	8-32V	650-1400mA	45	CASAMBI	71-A261-00-00
101,5x49x29	20	□	220-240V	50-60Hz	27-42V	350mA	14	Phase-Cut	71-A297-00-00
145x51x29,5	20	□	220-240V	50-60Hz	17-39V	700mA	25	Phase-Cut	71-A299-00-00
146x44x30	20	□	220-240V	50-60Hz	10-54V	300-1050mA	38	DALI2;PUSH	71-A303-00-00
66,3x38,5x21,8	20	□	100-240V	50-60Hz	8,6-18V	350mA	6	ON-OFF	71-A652-00-00
65x29x18	20	□	100-240V	50-60Hz	1,9-2,8V	700mA	3	Not Dimmable	71-A654-00-00
123x45x19	20	□	100-240V	50-60Hz	0	700mA	9,1	ON-OFF	71-B232-00-00
97,3x41x22	20	□	110-277V	50-60Hz	0	150-500mA	20	DALI2	71-B407-00-00
18x29x65	20	□	90-264V	50-60Hz	2,7-10V	350mA	3,5	ON-OFF	71-B417-00-00
165x45x37	68	□	100-240V	50-60Hz	6-14,5V	700mA	10	ON-OFF	71-E014-00-00
165x45x37	67	□	100-240V	50-60Hz	15-29V	700mA	20	ON-OFF	71-E015-00-00
155x80x70	65	□	100-240V	50-60Hz	8-14V	700mA	10	ON-OFF	71-E039-05-05
195x80x70	65	□	220-240V	50-60Hz	3-49V	250-700mA	20	DALI	71-E041-05-05
121,5x53,5x26	68	□	99-264V	50-60Hz	2-49V	350mA	17	ON-OFF	71-E079-00-00
121,5x53,5x26	68	□	99-264V	50-60Hz	2-49V	700mA	30	DALI2	71-E080-00-00
135x80x31	68	□	99-264V	50-60Hz	10-50V	350mA	17,5	0-10V;1-10V;DALI2	71-E083-00-00
135x80x31	68	□	99-264V	50-60Hz	10-50V	700mA	70	0-10V;1-10V;DALI2	71-E086-00-00
135x80x31	68	□	99-264V	50-60Hz	10-50V	1400mA	70	0-10V;1-10V;DALI2	71-E216-00-00
130x38x28	20	□	110-240V	50-60Hz	2-14V	1400mA	18	ON-OFF	71-E217-00-00
115x34x19	20	□	90-264V	50-60Hz	1-41,5V	60-360mA	15	ON-OFF	71-E218-00-00
110,4x52x22	20	□	110-240V	50-60Hz	10-53V	100-380mA	20	DALI	71-E219-00-00
110x76x30	20	⊕	100-240V	50-60Hz	2-44V	1050-2100mA	60	1-10V;DALI2;PUSH	71-E221-00-00
300x47x47	67	□	100-240V	50-60Hz	2-4V	1200mA	4,8	ON-OFF	71-E225-05-05
300x47x47	67	□	100-240V	50-60Hz	6-14,5V	700mA	10	ON-OFF	71-E226-05-05
155x80x70	20	□	220-240V	50-60Hz	2,5-5V	1200mA	6	ON-OFF	71-E364-05-05
135x80x31	68	□	99-264V	50-60Hz	10-50V	1200mA	60	1-10V;DALI2	71-E518-00-00

## Fuente de Alimentación / Fonte de alimentação

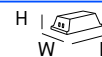

L x W x H mm	IP	CLASS	V in	Frecuencia Frequência	Constant voltage Vdc (V)	Potencia máxima (W) Potência máxima (W)	Protocol	
167x38,4x29,3	20	⊕	100-240V	50-60Hz	12V	20	ON-OFF	<b>71-5489-00-00</b>
202x71,2x45	67	⊕	100-240V	50-60Hz	24V	100	ON-OFF	<b>71-6341-00-00</b>
240x60x49	20	⊕	220-240V	50-60Hz	24V	150	ON-OFF	<b>71-6343-00-00</b>
244x71x37,5	67	⊕	100-305V	50-60Hz	24V	240	ON-OFF	<b>71-6345-00-00</b>
153x67x30,5	20	⊕	220-240V	50-60Hz	24V	39,9	PHASE CUT 240V	<b>71-6431-00-00</b>
219x63x35,5	67	⊕	100-305V	47-63Hz	48V	150	ON-OFF	<b>71-7646-00-00</b>
244x71x37,5	67	⊕	100-305V	47-63Hz	48V	240	ON-OFF	<b>71-7647-00-00</b>
191x63x38	67	⊕	90-305V	47-63Hz	24V	120	CASAMBI; PWM	<b>71-A242-00-00</b>
252x90x44	67	⊕	90-305V	47-63Hz	48V	320	ON-OFF	<b>71-B077-00-00</b>
262x43x125	67	⊕	90-305V	47-63Hz	48V	480	ON-OFF	<b>71-B078-00-00</b>
150x53x35	67	⊕	90-305V	47-63Hz	24V	60	DALI2	<b>71-E098-00-00</b>
191x63x37,5	67	⊕	90-305V	47-63Hz	24V	120	DALI2	<b>71-E099-00-00</b>
205x42x10	67	⊕	100-240V	50-60Hz	24V	20,16	ON-OFF	<b>71-E101-05-05</b>
148x40x32	67	⊕	90-305V	50-60Hz	24V	25	ON-OFF	<b>71-E158-00-00</b>
162,5x43x32	67	⊕	90-305V	50-60Hz	24V	60	ON-OFF	<b>71-E159-00-00</b>

## Sensores / Sensores



12V AC

L x W x H mm	V in F (Hz)	Luminarias Luminárias max.	Protocol		Code
120 x 40 x 35	220-240V 50-60Hz	4 Drivers	D4i	White Sensor D4i Connected to Track	<b>35-A075-14-00</b>
120 x 40 x 35	220-240V 50-60Hz	4 Drivers	D4i	Black Sensor D4i Connected to Track	<b>35-A075-60-00</b>

## Equipos de control / Equipamentos de controlo











IP20

L x W x H mm	IP	CLASS	V in	Frecuencia Frequência	Potencia máxima (W) Potência máxima (W)	Protocol	
153x65x20	20	⊕	12-24V 85-240V		4Chx48W	DMX	<b>71-3493-00-00</b>
40,4x36,3x14	20	⊕	220-240V 12-24V	50-60Hz	Max.150W (230V)	CASAMBI-RLC	<b>71-5959-00-00</b>
56,5x35,8x22,3	20	⊕	24-48V 220-240V	50-60Hz	Max. 1 driver	CASAMBI- DALI/O-10V	<b>71-5961-00-00</b>
30x72,6x18	66	⊕	100-240V 100-240V		Max.144W	CASAMBI- PWM	<b>71-8050-00-00</b>
143x18x59	20	⊕	100-240V 47-63Hz		Max. 64 devices	CASAMBI-DALI	<b>71-8115-00-00</b>
108x108x62	67	⊕	90-305V 47-63Hz	50-60Hz	Max. 64 devices	CASAMBI-DALI	<b>71-A237-00-00</b>
108x108x62	67	⊕	90-305V 47-63Hz	50-60Hz	Max. 32 devices	CASAMBI-DMX	<b>71-A238-00-00</b>
91x45x124	67	⊕	90-305V 47-63Hz	50-60Hz	Max. 64 devices	CASAMBI	<b>71-A243-14-14</b>
91x45x124	67	⊕	90-305V 47-63Hz	50-60Hz	Max. 64 devices	CASAMBI	<b>71-A243-60-60</b>









**Tabla para la selección de fuentes de alimentación y-o controladores**  
**Tabela para a selecção de fonte de alimentação e controladores**

		Fuente de alimentación no regulable Fonte de alimentação não regulável												Fuentes y controladores regulables Fontes e controladores reguláveis										
														1-10V	DALI2	DALI2	DALI	DALI DT8 2channel	DMX 4channel					
Referencia Referência	Serie XXXXXX	T Kelvin	P (W)	Vdc	L(m)	W/m	Metros máximos de tira que puede alimentar cada equipo Metros máximos de fita que pode alimentar cada fonte												71-0727	71-E098	71-E099	71-7708	71-B401	71-3493
							90-305	100-240	90-305	198-264	100-240	198-264	90-295	100-305	90-305	12/ 24VDC	100-305VAC	100-305VAC	100-305VAC	198-264VAC	12/ 24VDC			
							Tensión de salida Tensão de saída									12/ 24VDC	24VDC	24VDC	24VDC	24VDC	12/ 24VDC			
							24VDC									2x6.5A	60	120	150	160	4x2A			
							25	36	60	75	100	150	150	240	320	20	67	67	67	20	20			
							IP	67	20	67	20	67	20	67	67	XXX	XXX	XXX	XXX	XXX	XXX			
							PAG.	XXX	XXX	XXX	XXX	XXX	XXX	XXX	XXX	XXX	XXX	XXX	XXX	XXX	XXX			
Referencia Referência	Serie XXXXXX	T Kelvin	P (W)	Vdc	L(m)	W/m	Metros máximos de tira que puede alimentar cada equipo Metros máximos de fita que pode alimentar cada fonte												Metros máximos de tira que puede alimentar cada equipo Metros máximos de fita que pode alimentar cada fonte					
91-7908	BASIC 4,8	2700	24	24	5	4,8	5	6	11	14	18	28	28			59	11	23	28					
91-7909		3000	24	24	5	4,8	5	6	11	14	18	28	28			59	11	23	28					
91-7910		4000	24	24	5	4,8	5	6	11	14	18	28	28			59	11	23	28					
91-7911		6000	24	24	5	4,8	5	6	11	14	18	28	28			59	11	23	28					
91-7912		2700	24	24	5	4,8	5	6	11	14	18	28	28			59	11	23	28					
91-7913		3000	24	24	5	4,8	5	6	11	14	18	28	28			59	11	23	28					
91-7914		4000	24	24	5	4,8	5	6	11	14	18	28	28			59	11	23	28					
91-7915		6000	24	24	5	4,8	5	6	11	14	18	28	28			59	11	23	28					
91-A012		RGB	24	24	5	4,8																27		
91-3282	BASIC 9,6	2500	48	24	5	9,6	2	3	5	6	9	14	14	23	30	29	5	11	14					
91-7916		2700	48	24	5	9,6	2	3	5	6	9	14	14	23	30	29	5	11	14					
91-7917		3000	48	24	5	9,6	2	3	5	6	9	14	14	23	30	29	5	11	14					
91-7918		4000	48	24	5	9,6	2	3	5	6	9	14	14	23	30	29	5	11	14					
91-7919		6000	48	24	5	9,6	2	3	5	6	9	14	14	23	30	29	5	11	14					
91-7920		RGB	48	24	5	9,6																14		
91-7921		2700	48	24	5	9,6	2	3	5	6	9	14	14	23	30	29	5	11	14					
91-7922		3000	48	24	5	9,6	2	3	5	6	9	14	14	23	30	29	5	11	14					
91-7923		4000	48	24	5	9,6	2	3	5	6	9	14	14	23	30	29	5	11	14					
91-7924		6000	48	24	5	9,6	2	3	5	6	9	14	14	23	30	29	5	11	14					
91-7925		RGB	48	24	5	9,6																14		
91-7926	BASIC 14,4	2700	72	24	5	14,4	1	2	4	5	5	9	9	14	20	19	4	7	9					
91-7927		3000	72	24	5	14,4	1	2	4	5	5	9	9	14	20	19	4	7	9					
90-A013		3000	72	24	5	14,4	1	2	4	5	5	9	9	14	20	19	4	7	9					
91-2379		RGB	72	24	5	14,4																9		
91-7928	BASIC 19,2	2700	96	24	5	19,2	1	1	3	3	5	6	6	11	14	14	3	5	6					
91-A016		2700	96	24	5	19,2	1	1	3	3	5	6	6	11	14	14	3	5	6					
91-7929		3000	96	24	5	19,2	1	1	3	3	5	6	6	11	14	14	3	5	6					
91-5567		3000	96	24	5	19,2	1	1	3	3	5	6	6	11	14	14	3	5	6					
91-A014		4000	96	24	5	19,2	1	1	3	3	5	6	6	11	14	14	3	5	6					
91-A015		6000	96	24	5	19,2	1	1	3	3	5	6	6	11	14	14	3	5	6					
91-5571	BASIC 28,8	2700	144	24	5	28,8		1	2	2	3	5	5	7	10	9	2	4	5					
91-5572		3000	144	24	5	28,8		1	2	2	3	5	5	7	10	9	2	4	5					
91-5573		4000	144	24	5	28,8		1	2	2	3	5	5	7	10	9	2	4	5					

Receptores RF con mando a distancia Recetor RF com comando à distância				Frontal de pared Frontal de parede	Frontal blanco dinámico (TW) / Frontal branco dinâmico (TW)	Módulo Casambi PWM 4 canales / Módulo Casambi PWM 4 canales	Módulo Casambi PWM 1 canal / Módulo Casambi PWM 1 canal
RF Reciever 4 channel	RF Reciever 1 channel	RGB	White	PWM/RGBW	DALI DT8	Wireless	Wireless
							
<b>71-7669</b>	<b>71-7668</b>	<b>71-7667</b>	<b>71-7670</b>	<b>71-7664</b>	<b>71-B361</b>	<b>71-8050</b>	<b>71-A242</b>
12/24 Vdc	12/24 Vdc			12/24VDC	220-240VAC	12/24VDC	90-305VAC
12/24 VDC	12/24 VDC			12/24VDC	DALI (17V)	12/24VDC	24VDC
4×5A	96/192			4×5A	Max.52mA	6A	120
20	20			20	20	20	67
<b>XXX</b>	<b>XXX</b>	<b>XXX</b>	<b>XXX</b>	<b>XXX</b>	<b>XXX</b>	<b>XXX</b>	<b>XXX</b>
Metros máximos de tira que puede alimentar cada equipo Metros máximos de fita que pode alimentar cada fonte				Metros máximos de tira que puede alimentar cada equipo Metros máximos de fita que pode alimentar cada fonte	Metros máximos de tira que puede alimentar cada equipo Metros máximos de fita que pode alimentar cada fonte	Metros máximos de tira que puede alimentar cada equipo Metros máximos de fita que pode alimentar cada fonte	Metros máximos de tira que puede alimentar cada equipo Metros máximos de fita que pode alimentar cada fonte
	36						23
	36						23
	36						23
	36						23
	36						23
	36						23
	36						23
	36						23
67				67		28	
	18						11
	18						12
	18						12
	18						12
	18						12
33				33		14	
	18						12
	18						12
	18						12
	18						12
33				33		14	
	12						8
	12						8
22				22		9	
	9				Max. 25PSUs (52mA)		6
	9						6
	9						6
	9						6
	9						6
	9						6
	6						4
	6						4
	6						4

**Tabla para la selección de fuentes de alimentación y-o controladores**  
**Tabela para a selecção de fonte de alimentação e controladores**

		Fuente de alimentación no regulable Fonte de alimentação não regulável													Fuentes y controladores regulables Fontes e controladores reguláveis										
															1-10V	DALI2	DALI2	DALI	DALI DT8 2channel	DMX 4channel					
Referencia Referência	Serie XXXXXX	T Kelvin	P (W)	Vdc	L(m)	W/m	Metros máximos de tira que puede alimentar cada equipo Metros máximos de fita que pode alimentar cada fonte													71-0727	71-E098	71-E099	71-7708	71-B401	71-3493
							90-305	100-240	90-305	198-264	100-240	198-264	90-295	100-305	90-305	12/ 24VDC	100-305VAC	100-305VAC	100-305VAC	198-264VAC	12/ 24VDC				
							24VDC									12/ 24VDC	24VDC	24VDC	24VDC	24VDC	24VDC	12/ 24VDC			
							25	36	60	75	100	150	150	240	320	2x6.5A	60	120	150	160	4x2A				
							67	20	67	20	67	20	67	67	67	20	67	67	67	20	20				
							PAG.	XXX	XXX	XXX	XXX	XXX	XXX	XXX	XXX	XXX	XXX	XXX	XXX	XXX	XXX				
Referencia Referência	Serie XXXXXX	T Kelvin	P (W)	Vdc	L(m)	W/m	Metros máximos de tira que puede alimentar cada equipo Metros máximos de fita que pode alimentar cada fonte													Metros máximos de tira que puede alimentar cada equipo Metros máximos de fita que pode alimentar cada fonte					
91-7930	PERFORMANCE 9,6	2700	48	24	5	9,6	2	3	5	6	9	14	14	23	30	29	5	11	14						
91-7931		3000	48	24	5	9,6	2	3	5	6	9	14	14	23	30	29	5	11	14						
91-A020		3000	48	24	5	9,6	2	3	5	6	9	14	14	23	30	29	5	11	14						
91-A017		4000	48	24	5	9,6	2	3	5	6	9	14	14	23	30	29	5	11	14						
91-A019		RGBW	48	24	5	9,6																18			
91-A021		RGBW	48	24	5	9,6																18			
91-7932	PERFORMANCE 14,2	2700	72	24	5	14,4	1	2	4	5	5	9	9	14	20	19	4	7	9						
91-7933		3000	72	24	5	14,4	1	2	4	5	5	9	9	14	20	19	4	7	9						
91-A023		3000	72	24	5	14,4	1	2	4	5	5	9	9	14	20	19	4	7	9						
91-A022		4000	72	24	5	14,4	1	2	4	5	5	9	9	14	20	19	4	7	9						
91-7934	PERFORMANCE 19,2	2700	96	24	5	19,2	1	1	3	3	5	6	6	11	14	14	3	5	6						
91-A024		2700	96	24	5	19,2	1	1	3	3	5	6	6	11	14	14	3	5	6						
91-7935		3000	96	24	5	19,2	1	1	3	3	5	6	6	11	14	14	3	5	6						
91-A025		3000	96	24	5	19,2	1	1	3	3	5	6	6	11	14	14	3	5	6						
91-7936		4000	96	24	5	19,2	1	1	3	3	5	6	6	11	14	14	3	5	6						
91-7937		RGB	72	24	5	14,4																10			
91-7938	RGBW	96	24	5	19,2																10				
91-7939	2500-6000	96	24	5	19,2																8				
91-7940	PERFORMANCE 28,8	2700	144	24	5	28,8		1	2	2	3	5	5	7	10	9	2	4	5						
91-7941		3000	144	24	5	28,8		1	2	2	3	5	5	7	10	9	2	4	5						
91-A026	ON ADVANCED COB	3000	40	24	5	8,0	3	4	6	8	11	16	16	27		35	6	14	16						
91-A000	ASAI 3D	3000	14	24	1	14,4	1	2	4	5	5	9	9	14	20	19	4	7	9						
91-A002		4000	14	24	1	14,4	1	2	4	5	5	9	9	14	20	19	4	7	9						
91-A001		3000	115,2	24	8	14,4	1	2	4	5	5	9	9	14	20	19	4	7	9						
91-A003		4000	115,2	24	8	14,4	1	2	4	5	5	9	9	14	20	19	4	7	9						
91-A004		RGB	14,4	24	1	14,4																10			
91-A005	RGB	115,2	24	8	14,4																10				
91-6607	ASAI SIDE BEND	3000	14,4	24	1	14,4	1	2	4	5	5	9	9	14	20	19	4	7	9						
91-7964		4800	14,4	24	1	14,4	1	2	4	5	5	9	9	14	20	19	4	7	9						
91-7968		RGB	14,4	24	1	14,4	1	2	4	5	5	9	9	14	20	19	4	7	9						
91-6608		3000	115,2	24	8	14,4	1	2	4	5	5	9	9	14	20	19	4	7	9						
91-7965		4800	115,2	24	8	14,4	1	2	4	5	5	9	9	14	20	19	4	7	9						
91-7969		RGB	115,2	24	8	14,4																9			
91-6609	ASAI TOP BEND	3000	14,4	24	1	14,4	1	2	4	5	5	9	9	14	20	19	4	7	9						
91-7966		4800	14,4	24	1	14,4	1	2	4	5	5	9	9	14	20	19	4	7	9						
91-7970		RGB	14,4	24	1	14,4																9			
91-6610		3000	115,2	24	8	14,4	1	2	4	5	5	9	9	14	20	19	4	7	9						
91-7967		4800	115,2	24	8	14,4	1	2	4	5	5	9	9	14	20	19	4	7	9						
91-7971	RGB	115,2	24	8	14,4																9				

Receptores RF con mando a distancia Recetor RF com comando à distância				Frontal de pared Frontal de parede	Frontal blanco dinámico (TW) / Frontal branco dinâmico (TW)	Módulo Casambi PWM 4 canales / Módulo Casambi PWM 4 canales	Módulo Casambi PWM 1 canal / Módulo Casambi PWM 1 canal
RF Reciever 4 channel	RF Reciever 1 channel	RGB	White	PWM/RGBW	DALI DT8	Wireless	Wireless
							
<b>71-7669</b>	<b>71-7668</b>	<b>71-7667</b>	<b>71-7670</b>	<b>71-7664</b>	<b>71-B361</b>	<b>71-8050</b>	<b>71-A242</b>
12/24 Vdc	12/24 Vdc			12/24VDC	220-240VAC	12/24VDC	90-305VAC
12/24 VDC	12/24 VDC			12/24VDC	DALI (17V)	12/24VDC	24VDC
4×5A	96/192			4×5A	Max.52mA	6A	120
20	20			20	20	20	67
<b>XXX</b>	<b>XXX</b>	<b>XXX</b>	<b>XXX</b>	<b>XXX</b>	<b>XXX</b>	<b>XXX</b>	<b>XXX</b>
Metros máximos de tira que puede alimentar cada equipo Metros máximos de fita que pode alimentar cada fonte				Metros máximos de tira que puede alimentar cada equipo Metros máximos de fita que pode alimentar cada fonte	Metros máximos de tira que puede alimentar cada equipo Metros máximos de fita que pode alimentar cada fonte	Metros máximos de tira que puede alimentar cada equipo Metros máximos de fita que pode alimentar cada fonte	Metros máximos de tira que puede alimentar cada equipo Metros máximos de fita que pode alimentar cada fonte
	18						12
	18						12
	18						12
	18						12
45				45		14	
45				45		14	
	12						8
	12						8
	12						8
	12						8
	9						6
	9						6
	9						6
	9						6
	9						6
22				22		9	
22				22		7	
					Max. 25PSUs (52mA)	7	
	6						4
	6						4
	21						14
	12						8
	12						8
	12						8
	12						8
22				22		9	
22				22		9	
	12						8
	12						8
	12						8
	12						8
	12						8
22				22		9	
	12						8
	12						8
22				22		9	
	12						8
	12						8
22				22		9	
	12						8
	12						8



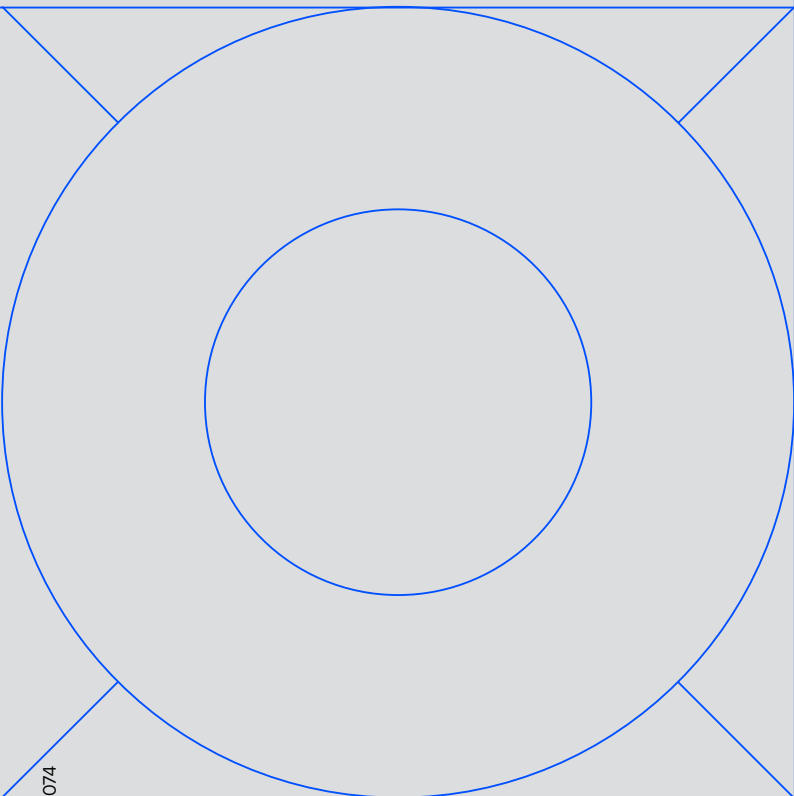



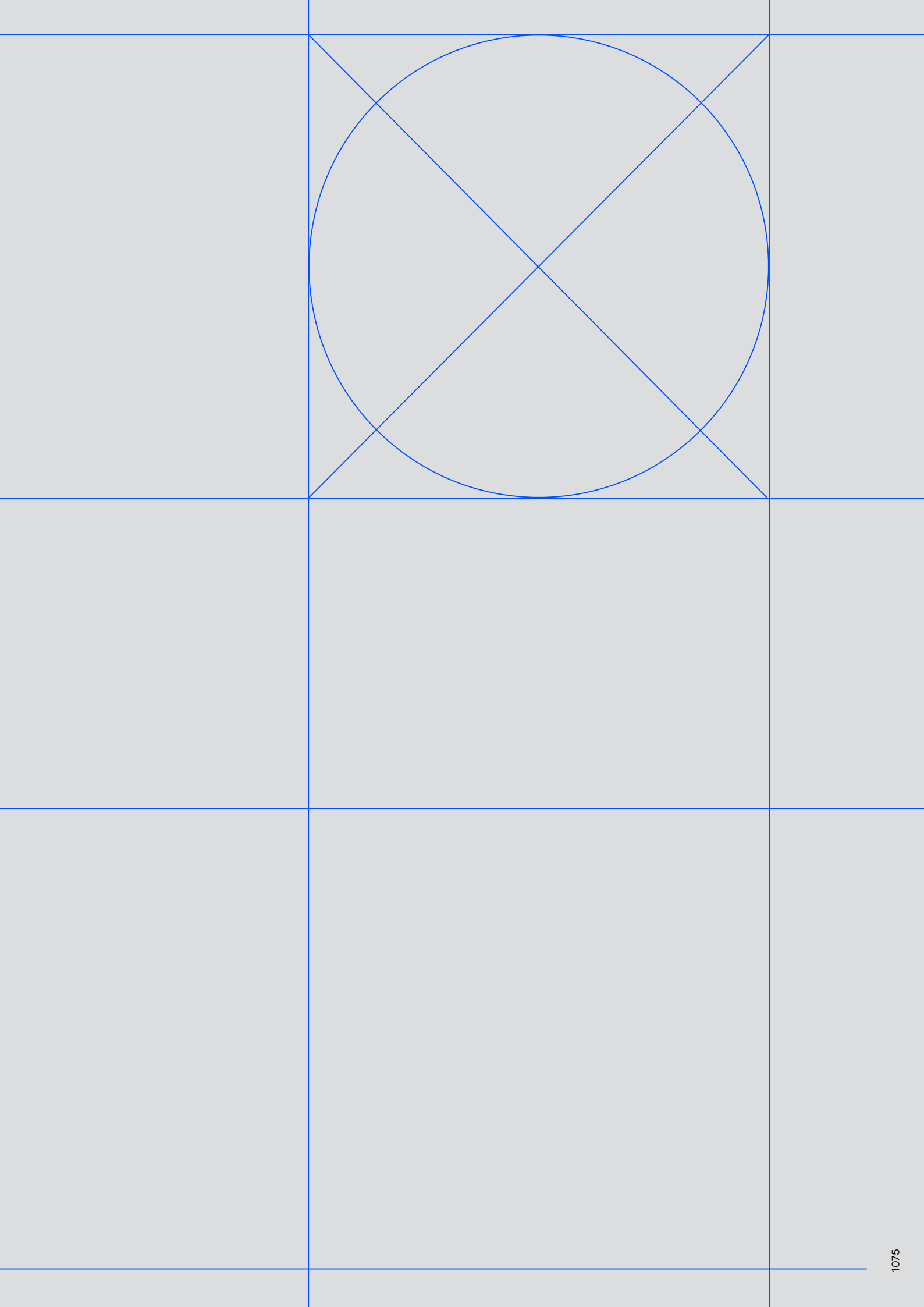



















# Extra Reader's Guide























































**Acabados / Acabamentos**







	00	Blanco	Branco
	18	Marrón	Castanho
	21	Cromo	Cromado
	23	Oro	Ouro
	37	Transparente	Transparente
	48	Acero cincado	Aço zincado
	54	Aluminio anodizado	Alumínio anodizado
	55	Alabastro	Alabastro
	AF	Aluminio satinado	Alumínio Acetinado
	BW	Blanco	Branco
	CA	Acero inoxidable AISI 316	Aço Inoxidável AISI 316
	DC	Cemento	Cimento
	EF	Oro	Ouro
	EN	Madera nogal	Madeira nogueira
	EO	Madera roble	Madeira carvalho
	EP	Oro intenso	Ouro intenso
	ES	Rattan natural	Rattan natural
	G7	Negro texturizado	Preto texturizado
	GA	Filtro gris claro	Filtro cinzento claro
	GB	Filtro gris oscuro	Filtro cinzento escuro
	H2	Blanco texturizado	Branco texturizado
	I6	Anodizado gratado	Anodizado escovado
	I7	Oro PVD	Ouro PVD
	I8	Gun Metal PVD	Gun Metal PVD
	L7	Negro/Negro/Negro	Preto/Preto/Preto
	L8	Negro/Oro/Oro	Preto/Ouro/Ouro
	L9	Negro/Oro/Transparente	Nero/Ouro/Transparente

## Acabados / Acabamentos

























	M1	Blanco opal	Branco opalino
	M3	Anodizado	Anodizado
	N3	Gris	Cinzento
	O1	Blanco/Oro/Oro	Branco/Ouro/Ouro
	O2	Blanco/Oro/Blanco	Branco/Ouro/Branco
	O3	Oro/Oro/Oro	Ouro/Ouro/Ouro
	O4	Oro/Oro/Transparente	Ouro/Ouro/Transparente
	O5	Negro/Gris/Gris	Preto/Cinzento/Cinzento
	O6	Negro/Gris/Transparente	Nero/Cinzento/Transparente
	O7	Blanco/Gris/Gris	Branco/Cinzento/Cinzento
	O8	Blanco/Gris/Transparente	Branco/Cinzento/Transparente
	O9	Gris/Gris/Gris	Cinzento/Cinzento/Cinzento
	P7	Gris/Gris/Transparente	Cinzento/Cinzento/Transparente
	WG	Blanco/Oro	Branco/Ouro
	WH	Negro/Blanco	Preto/Branco
	WI	Oro/Blanco	Ouro/Branco
	WJ	Oro/Oro	Ouro/Ouro
	WK	Oro/Negro	Ouro/Preto
	WL	Negro/Blanco	Preto/Branco
	WM	Negro/Oro	Preto/Ouro
	WN	Negro/Negro	Preto/Preto
	WP	Sin marco/Blanco	Trimless/Branco
	WQ	Sin marco/Negro	Trimless/Preto
	WR	Blanco/blanco	Branco/blanco
	WS	Sin marco/Oro	Trimless/Ouro
	WT	Sin marco/Blanco	Trimless/Branco

## Simbología / Simbologia

	Sistema de codificación para indicar el grado de protección proporcionado por un envolvente contra la entrada de elementos sólidos y líquidos	Sistema de codificação para a indicação do grau de proteção proporcionado por um envolvente contra a entrada de objetos sólidos e líquidos
	Novedad	Novidade
	Material de la estructura	Material da estrutura
	Sistema de codificación para indicar el grado de protección proporcionado por un envolvente contra los impactos mecánicos nocivos. Energía de impacto (Jules)	Sistema de codificação para a indicação do grau de proteção proporcionado por um envolvente contra os impactos mecánicos nocivos. Energia de impacto (joules)
	Material del difusor	Material do difusor
	UGR	UGR
	Low Flicker	Low Flicker
	Clase I	Classe I
	Clase II	Classe II
	Clase III	Classe III
	Horas de vida	Horas de vida
	Cumple con la eficacia luminosa exigida para obtener el certificado de construcción sostenible BREEAM, calculada dividiendo los lúmenes reales por la potencia total de la luminaria.	Cumprir a eficácia luminosa exigida para obter o certificado de construção sustentável BREEAM, calculada pela divisão dos lúmenes reais pela potência total da luminária.
	MacAdam	MacAdam
	WELL. Contribuye al cumplimiento de la característica L06 según el WELL Building Standard®.	WELL. Contribui para o cumprimento da característica L06 de acordo com o WELL Building Standard®.
	Switch CCT	Switch CCT
	RGB Light	RGB Light
	Luminarias no adecuadas para cubrirse con material aislante térmico	Luminárias não adequadas para serem cobertas com material isolante térmico
	Luminarias no adecuadas para el montaje directo en superficies normalmente inflamables	Luminárias não adequadas para a montagem direta em superfícies normalmente inflamáveis
	ATENCIÓN - Esta luminaria puede soportar una carga estática limitada. ES APTA para zonas donde eventualmente circulan vehículos a baja velocidad. NO ES APTA para zonas de paso habitual de vehículos	ATENÇÃO - Esta luminária pode suportar uma carga estática limitada. É ADEQUADA para zonas onde, eventualmente, circulam veículos a baixa velocidade. NÃO É ADEQUADA para zonas de passagem habitual de veículos
	Nº de metros máximos. de conexión en serie	Nº de metros máximo de ligação em série
	x metros de cable	x metros de cabo
	Doble salida de cable	Dupla saída de cabos
	Luminaria adecuada para instalar en ambientes con atmósfera marina	Luminária adequada para instalar em ambientes com atmosfera marinha

	Drenaje. Ver las recomendaciones de instalación a la pág. XXX	Drenagem. Ver as recomendações de instalação na pág. XXX
	Incluye sistema de fijación al suelo desarrollada por LEDS C4 que garantiza la robustez y durabilidad de las luminarias y que entre ellas no haya diferencias de inclinación aunque el suelo sea irregular.	Inclui um sistema de fixação ao solo desenvolvido pela LEDS C4 que garante a robustez e durabilidade das luminárias e que entre elas não existam diferenças de inclinação, mesmo que o solo seja irregular.
	Orientable	Orientável
	Orientable	Orientável
	Orientable	Orientável
	Orientable	Orientável
	Orientable	Orientável
	Orientable	Orientável
	Orientable	Orientável
	Orientable	Orientável
	Interruptor de encendido	Interruptor de ligar/desligar
	Doble interruptor de encendido	Duplo interruptor de ligar/desligar
	Interruptor táctil	Interruptor tátil
	Interruptor de encendido en el cable	Interruptor de ligar/desligar no fio
	Espejo de aumento x5	Espelho de aumento x5
	Espejo de aumento x3	Espelho de aumento x3
	Mando a distancia	Comando à distância
	Nº de metros máximos. de conexión en serie	Nº de metros máximo de ligação em série
	Antifog. Sistema incluido para evitar que el espejo se empañe con el vapor de agua.	Antineblina. Sistema incluído para evitar que o espelho embacice com o vapor de água.
	La lámina de seguridad es una película aplicada en el reverso de los espejos para evitar las lesiones causadas en caso de rotura del cristal.	A lâmina de segurança é uma película aplicada na parte posterior dos espelhos para evitar lesões provocadas em caso de quebra do vidro.
	Luminaria apta para el paso de vehiculos según normativa EN 60598-2-13 (ensayos de resistencia a la torsión y carga cortante).	Luminária adequada à passagem de veículos segundo a norma EN 60598-2-13 (ensaios de resistência à torção e força cortante).
	Airflow (CFM). Unidad de medida del caudal de aire del ventilador (pies cúbicos por minuto).	Airflow (CFM). Unidade de medida do caudal de ar do ventilador (pés cúbicos por minuto).
	DC Motors. Motor de corriente continua. Mejor eficiencia y consumo.	DC Motors. Motor de corrente contínua. Melhor eficiência e consumo.
	Incorpora fuente de luz	Incorpora fonte de luz
	Material de las palas	Material das lâminas

## Simbología / Simbologia

	La función inversa hace girar las palas en sentido contrario. Durante los meses de frío, permite desplazar el aire caliente desde el techo hasta el suelo y calentar la estancia ahorrando energía usándolo con el sistema de calefacción.	A função inversa faz rodar as lâminas em sentido contrário. Durante os meses frios, permite deslocar o ar quente do teto para o chão e aquecer a divisão poupando energia utilizando-o com o sistema de aquecimento.
	Velocidad de ventilación, velocidad de giro del motor.	Velocidade de ventilação, velocidade de rotação do motor.
	Conexión USB	Ligação USB
	Conexión USB-C	Ligação USB-C
	Corte a medida	Corte à medida
	Fuente de luz no reemplazable	Fonte de luz não substituível
	Fuente de luz reemplazable por un técnico cualificado	Fonte de luz substituível por um técnico qualificado
	Fuente de luz reemplazable por el usuario final	Fonte de luz substituível pelo usuário final
	Driver no reemplazable	Driver não substituível
	Driver reemplazable por un técnico cualificado	Driver substituível por um técnico qualificado
	Driver reemplazable por el usuario final	Driver substituível pelo usuário final
	Wireless	Wireless
	Sensor	Sensor
	Luminarias con conectividad integrada.	Luminárias com conectividade integrada.
	Luminarias que pueden ser conectivas mediante un accesorio conectivo.	Luminárias que podem ser conectivas mediante um acessório conectivo.
	Luminarias con conectividad integrada.	Luminárias com conectividade integrada.
	Luminarias que pueden ser conectivas mediante un accesorio conectivo.	Luminárias que podem ser conectivas mediante um acessório conectivo.
	Equipo no incluido	Equipamento não incluído
	Equipo incluido	Equipamento incluído
	Los anclajes permiten su instalación en techos de X mm a X mm	As fixações permitem a sua instalação em tetos de X mm a X mm
	Consultar disponibilidad	Consultar Disponibilidade
	Consultar disponibilidad	Consultar Disponibilidade
	Diámetro de empotramiento	Diâmetro de encastramento
	Corte de empotramiento	Corte de encastramento
	El driver sí pasa por el agujero de empotrar	O driver passa pelo orifício de encastrar
	El driver no pasa por el agujero de empotrar	O driver não passa pelo orifício de encastrar



Variación de la temperatura de color de blanco  
cálido a frío

Variação da temperatura de cor de branco quente  
a frio



**Materiales / Materiais**

<b>ABS</b>	ABS	ABS
<b>ACR</b>	Acrílico	Acrílico
<b>AISI202</b>	Acero inoxidable AISI 202	Aço inoxidável AISI 202
<b>AISI304</b>	Acero inoxidable AISI 304	Aço inoxidável AISI 304
<b>AISI316</b>	Acero inoxidable AISI 316	Aço inoxidável AISI 316
<b>AL</b>	Aluminio	Alumínio
<b>ALAB</b>	Alabastro	Alabastro
<b>BR</b>	Latón	Latão
<b>CON</b>	Cemento	Cimento
<b>FELT</b>	Fieltro	Feltro
<b>G</b>	Grafeno	Grafeno
<b>GL</b>	Fibra de vidrio	Fibra de vidro
<b>GLA</b>	Cristal	Vidro
<b>PC</b>	Policarbonato	Policarbonato
<b>PC+ABS</b>	Policarbonato + ABS	Policarbonato + ABS
<b>PLABS</b>	Plástico	Plástico
<b>PLSTER</b>	Yeso	Gesso
<b>PMMA</b>	PMMA	PMMA
<b>POLI</b>	Tecnopolímero	Tecnopolímero
<b>PP</b>	Polipropileno	Polipropileno
<b>PVC</b>	PVC	PVC
<b>R</b>	Resina	Resina
<b>ST</b>	Acero	Aço
<b>WOOD</b>	Madera	Madeira
<b>WOODT</b>	Madera de teca	Madeira de teca



**LedsC4** S.A.  
Afores s/n 25750 Torà  
Lleida – Spain  
+34 973 468 100  
ledsc4@ledsc4.com